



Includes
complete
information
on air
brakes

Driving commercial vehicles

A guide for professional drivers

What to take to the driver licensing office

Whether you're applying for your first commercial driver licence, a driver from another jurisdiction or you're taking a re-examination, please be prepared when you arrive at our office.

Always take primary and secondary identification, and fees for the services or licences you are requesting.

For the knowledge test you need:

- primary and secondary identification (see inside of back cover)
- your current licence
- the fees for the knowledge test and any outstanding debt.

Make sure you arrive at the office at least one hour before closing to take your knowledge test.

For the road tests you need:

- primary and secondary identification
- your current licence
- a safe vehicle or combination that is acceptable for the class of licence you are applying for, with registration and insurance papers — write down the licence plate number(s) of the vehicle(s) so that you can tell our staff these numbers
- the fees for the road test and photo licence and any outstanding debts
- glasses or contact lenses, if you require them to drive.

Make sure you arrive at the office at least 15 minutes before your road test appointment time.

Notes: All road tests are by appointment only. You must book ahead.

If you can't keep your road test appointment, you need to notify ICBC.

A fee is charged if you do not show up for your scheduled road test and do not provide either 48 hours notice or a valid reason for not attending.

Knowledge and road test fees vary depending on which tests you will be taking. The fees are listed on icbc.com.

To learn more about getting your driver's licence, read **chapter 1, getting your driver's licence**.

Study + Practice = Success

Prepare for your tests! If you do not qualify on any knowledge test, pre-trip or road test you will need to wait before another attempt can be made.

Re-test waiting periods

Failed attempt	Knowledge & pre-trips	Class 1-4 road tests	Endorsement 20 road tests
1 st	7 days	14 days	14 days
2 nd	7 days	30 days	30 days
3 rd +	7 days	30 days	60 days

driving commercial vehicles

a guide for professional drivers

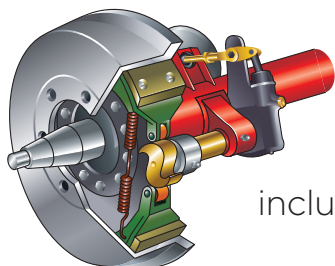
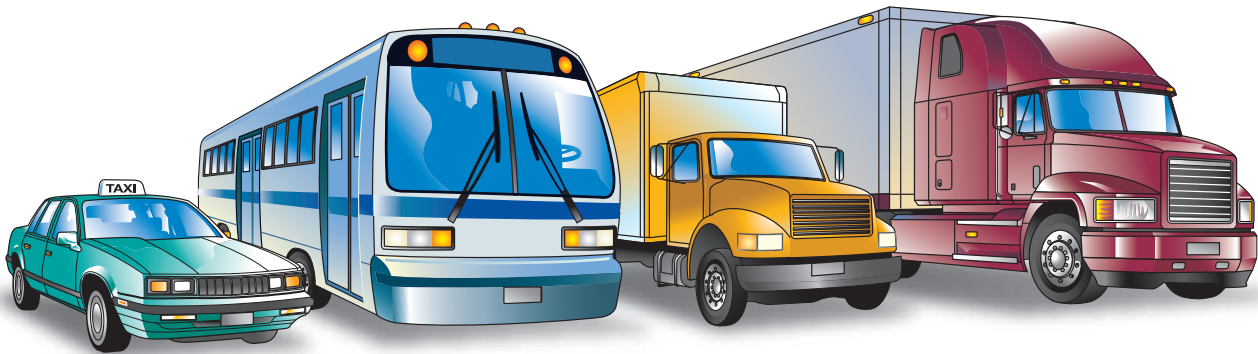

includes complete information on air brakes

Acknowledgements

This guide is based in part on *Air Brakes from the Drivers Seat II* by Allan C. Wright and on material from the *British Columbia Air Brake Manual*. ICBC gratefully acknowledges the contribution of all parties who have contributed to the publication of *Driving Commercial Vehicles*.

© 2024 Insurance Corporation of British Columbia

All rights reserved. No part of this publication may be reproduced, stored or transmitted in any form, whether electronic, mechanical, photocopied or otherwise, without the prior written consent of the Insurance Corporation of British Columbia (ICBC). Applications for ICBC's written consent should be made to ICBC, 151 West Esplanade, North Vancouver BC V7M 3H9.

Notwithstanding the foregoing paragraph, it is permissible to download and/or print one copy of this publication from **icbc.com** for personal use only.

Statement of Limitation

ICBC has prepared *Driving Commercial Vehicles* to assist individuals studying for a Class 1, 2, 3 or 4 (restricted or unrestricted) British Columbia driver's licence, an air brake endorsed driver's licence, an industrial air brake endorsement, or a heavy trailer endorsement. It has also been prepared for use as a source text for ICBC-approved air brake courses.

Driving Commercial Vehicles is not intended to take the place of professional training and ICBC does not make any representation or warranty that any individual who studies *Driving Commercial Vehicles* will be successful in obtaining the desired licence or endorsement. ICBC is not responsible for any consequences that may result from the use of *Driving Commercial Vehicles*.

Throughout this guide, references are made to acts and regulations that govern driving and the design and construction of air brake-equipped vehicles in British Columbia. This guide reflects the law in British Columbia as set out in these acts and regulations as of August 27, 2024. These references are written in plain language for ease of understanding. In the event of a difference between the material included in *Driving Commercial Vehicles* and any of these acts or regulations, the acts or regulations shall apply.

The illustrations and explanations of various types of vehicles, vehicle components and air brake systems are provided for instructional purposes, and are not to be interpreted in any way as superseding vehicle, vehicle component, or air brake system specifications as may be required by law. Each vehicle and its air brake systems may have features and components that are different from those described in this guide.

contents

introduction	1
Using this guide	1
Inside this guide	2
Licence study chart	2
Chapter 1: getting your driver's licence	3
What you'll learn	3
Licence classes	3
Medical fitness	5
Vision	5
Air brake endorsement	5
How to apply for an air brake endorsement.....	5
How to apply for a Class 1, 2, 3 or 4 driver's licence	6
How to apply for a heavy trailer endorsement	7
Knowledge tests	8
Road testing	8
Pre-trip inspection test	9
Road test	10
Road test vehicles	10
Strategies to ensure your vehicle is safe	11
Retest.....	12
Commercial driver training	12
Air brake courses	13
Keeping your licence	13
Review questions	14
Commercial driver medical examination processing fee	14
Upgrading your commercial licence	14
Downgrading to a non-commercial licence	14
Downgrading to a lower commercial licence class	14
Chapter 2: heavy vehicle braking	15
What you'll learn	15
Starting and stopping	15
Power to move and power to stop	16
Stopping distance and stopping time	17
Speed and weight facts	18
How much heat can brakes handle?	19
Retarders	20
Using retarders	20

Braking	21
Icy roads.....	21
Downgrades	21
On highways.....	22
In town.....	22
Water on roadways.....	23
Runaway lanes	23
Combination unit braking	23
Anti-lock braking systems.....	23
Automatic traction control	25
Review questions	25
Chapter 3: basic driving skills	27
What you'll learn	27
Sharing the road	27
Following distance.....	27
Taxi, limousine, ride-hailing vehicle, ambulance or van	28
Bus, truck or other heavy vehicle	28
Traffic flow.....	28
Driving faster than the flow.....	28
Driving slower than the flow	29
Tailgaters	29
Construction zones.....	30
Danger zones	30
Manoeuvring	31
Steering into turns.....	31
Wheel positions during turns	31
Turning radius.....	31
Off track.....	32
Curves and turns.....	34
Curves.....	34
Negotiating narrow bridges.....	35
Turning right.....	35
Sharp right turns.....	36
Turning left	38
Traffic circles and roundabouts	38
Traffic circles.....	38
Roundabouts	39
Backing up	39
Backing up with a guide	41
Backing up without a guide	41

Seeing and being seen	42
Using your mirrors	43
Looking ahead.....	43
Which lane should you use?.....	43
Lane use.....	43
Emergency vehicles	44
Stopped vehicles with flashing lights.....	44
Shifting gears	44
Knowing how to shift gears.....	45
Double-clutching.....	45
Knowing when to shift gears.....	45
Shifting skills	46
Shifting gasoline-powered (not governed) engines	46
Shifting gasoline- or diesel-powered governed engines	46
Multi-speed rear axles and auxiliary transmissions.....	47
Entering curves.....	47
Passing and being passed	47
Passing	48
Being passed	48
Parking	48
Crossings	49
Intersections	49
Alleys, lanes and side roads	50
Railway crossings.....	51
Controlled and uncontrolled crossings	51
Crossing in a large vehicle	51
Acts of nature	53
Animals on the road	53
Weather conditions	53
Night driving.....	54
Vehicle safety	55
Tires and wheels.....	55
Tire pressure	55
Tire wear	55
Tire condition	56
Tire problems	56
Disk wheel problems.....	57
Cast spoke wheel problems.....	57
Brake failure warning devices	57
Braking systems	57
Flashing lights	58
Disabled vehicles.....	58

Personal safety	59
Carbon monoxide poisoning	59
Seatbelts	59
Airbags and head restraints	60
Cellphones and other devices	60
Impairment	61
Criminal Code penalties	62
Other costs of impaired driving	62
Vehicle impoundment.....	62
Prescribed and over-the-counter drugs.....	63
Fatigue	63
Emotions	63
Fire.....	63
Firefighting.....	64
Fire extinguishers	64
Vehicles required to carry fire extinguishers	65
Review questions	65
Chapter 4: fuel-efficient driving	67
What you'll learn	67
Fuel efficiency — a growing priority	67
Making smart choices.....	67
Smart driving practices	67
Preparation and planning.....	68
Fuel.....	68
Route planning.....	68
Dealing with the weather	68
Starting	68
Smart driving techniques	69
Start out easy.....	69
Choose the right gear	69
Ease off the throttle	69
Use see-think-do.....	69
Road and traffic conditions	70
Reduce idling	70
Maintaining your vehicle	71
Choosing a fuel-efficient vehicle	72
Choose the right truck	72
Look for aerodynamic features	72
Tire choice.....	73
Accessories.....	73
Review questions	74

Chapter 5: skills for driving trucks and trailers	75
What you'll learn	75
Driving with a trailer	75
Backing up.....	75
Towing trailers.....	76
Towing doubles	76
Swerving and whipping.....	77
Parking.....	78
Preparing to tow	78
Coupling and uncoupling	78
Coupling with a fifth wheel	78
Uncoupling units	83
Other types of connections.....	85
Coupling with a pintle hitch.....	85
Uncoupling pintle hitch units	88
Loading	89
Loading cargo.....	89
Arranging and distributing loads	90
Securing cargo.....	92
General cargo securement requirements	92
General requirements for tiedowns.....	93
Number of tiedowns	93
Strength of tiedowns.....	95
Determining working load limit	95
Chain connector links.....	95
Front-end structures.....	100
Load projections.....	101
Specific cargo types	102
Logs.....	102
Building products.....	103
Metal coils	104
Paper rolls.....	105
Concrete pipe	105
Intermodal containers	105
Vehicles as cargo	106
Roll-on/roll-off and hook-lift containers	106
Boulders	107
Livestock.....	107
Hanging meat	107
Liquid or dry bulk tank loads.....	107
Transporting dangerous goods.....	108
Vehicle and load dimensions	109

Height.....	110
Width.....	110
Length	111
Weight.....	111
Oversize and overload permits	111
Overload permits	112
Oversize permits	112
Pilot cars	112
Signs.....	113
Distance from oversize vehicle	113
Reporting to weigh scales	113
Fixed weigh scales	114
Portable weigh scales.....	114
Review questions.....	115
Chapter 6: skills for driving buses, taxis, limousines and ride-hailing vehicles.....	117
What you'll learn.....	117
Passenger safety.....	118
Manoeuvring	119
Leaving the curb.....	119
Bus right-of-way.....	120
Passing parked cars	120
Operating a bus, taxi, limousine or ride-hailing vehicle	121
Taking on and letting off passengers	121
Smoking.....	121
Focus on driving	121
Standing passengers	121
Refusing to transport passengers.....	122
Let-down or jump seats.....	122
Transporting people with disabilities	122
Chauffeur's permit	123
Inside lights.....	123
Vehicle cleanliness.....	123
Vehicle inspection.....	123
Emergency equipment and exits	123
Defects and breakdowns	124
Fuelling	124
Baggage	124
Smoking and using alcoholic beverages	124
Reporting a defect or deficiency.....	125

Operating a school bus	125
Unfit vehicles	125
Rental buses	125
Brake maintenance.....	125
Mechanical defects.....	125
Refuelling.....	126
Emergency equipment and exits	126
School bus signs.....	126
Exterior mirrors	126
Passengers must be seated	126
Cleanliness.....	127
Taking on and letting off passengers	127
Operating emergency vehicles	127
Review questions	129
Chapter 7: hours of service requirements	131
What you'll learn	131
National Safety Code	131
Hours of service	131
On-duty time	132
Off-duty time	132
Day.....	132
Daily limits — a simple three-point check for compliance	133
Work shift.....	133
Daily hours (cycles)	133
Driver has 'deferred' two hours from Day 1 to Day 2	134
Deferring off-duty time.....	134
Reset provision	134
Sleeper berth.....	134
Personal use exemption	136
Logbooks	136
Sample logbook	137
Drivers operating within 160 km of home terminal	138
Other jurisdictions	138
Driving north of the 60th parallel	138
Driving into the U.S.	139
Review questions	140
Chapter 8: air brakes	141
What you'll learn	141
Why air brakes?	141
What's compressed air?.....	141

Basic air brake components	142
Force multipliers	143
Air brake chamber components	143
Leverage and air pressure	144
Long stroke and regular stroke brake chambers	144
Air brake chamber — air pressure applied	144
Foundation brakes: s-cam type	145
Compressor	146
Intake stroke	147
Compression stroke.....	148
Governor	148
Reservoirs	149
Foot valve	149
How air brakes work	150
Brakes applied.....	150
Brakes released	151
Dual air brake systems	151
Components of a dual air brake system	152
Supply, primary and secondary reservoirs	152
One-way check valve	152
Reservoir pressure gauges	153
Low-air warning device	153
Quick release valve	154
Relay valve	155
Dual system with primary system failure	156
Parking brakes	156
Spring parking brakes	157
Applying and releasing spring parking brakes	158
Spring parking brake — released	158
Spring parking brake — service brake applied	159
Spring parking brake — spring brake applied	160
Driver alert — compounding of brakes	160
Spring parking brake — manual release	160
Spring parking brakes in dual air brake systems	161
Blended air	162
Dual air brake system — partial system failure.....	162
Safety actuator parking brakes	163
Tractor-trailer air brake systems	164
Trailer with relay emergency valve — charging	165
Trailer with relay emergency valve — applying	165
Trailer with relay emergency valve — dynamited	166
Trailer with spring parking brakes — charging	166

Trailer with spring parking brakes — service brake application	167
Trailer with spring parking brakes — dynamited	168
Tractor protection	168
Trailer air supply valve	169
Hand valve	169
Two-way check valve	170
Bobtail tractors	170
Dual air tractor-trailer system — foot valve applied	171
Dual tractor-trailer system — primary air system failure	172
Dual tractor-trailer system — trailer breakaway	173
Other types of foundation brakes	173
Wedge brakes	174
Air disc brakes	174
Air-over-hydraulic brakes	175
Other air brake system components	176
Air dryers	176
Alcohol evaporators and alcohol injectors	177
Automatic drain valves	178
Front wheel limiting systems	178
Automatic front wheel limiting systems	178
Manual front wheel limiting systems	179
Spring parking brake emergency release system	179
Pressure-protection valves	180
Application pressure gauges	180
Anti-lock braking systems	180
Trailer ABS air brake systems	182
Review questions	183
Chapter 9: air brake adjustment	185
What you'll learn	185
Brake adjustment — it's critical	185
Brake adjustment — it's the law	185
S-cam brake — released	185
S-cam brake — applied	186
S-cam brake — incorrectly adjusted and cold brake drum	186
S-cam brake — incorrectly adjusted and hot brake drum	187
Checking and adjusting s-cam brakes — manual slack adjuster	187
Applied stroke method (service brake application)	188
Pry method of free stroke measurement	188
Brake adjustment indicators	189
Brake adjustment — manual slack adjuster	189
Adjustment	190

S-cam brakes — automatic slack adjuster	191
Checking and adjusting automatic slack adjusters	191
Slack adjusters with hexagonal adjusting bolts	192
Slack adjusters with square adjusting bolts	193
Air brake adjustment myths	193
Review questions	194
Chapter 10: vehicle and air brake pre-trip inspections	195
What you'll learn	195
You're responsible	195
Vehicle condition	196
Cargo securement	196
Written report requirements	197
Pre-trip inspection report for your road test	197
Conducting a pre-trip inspection	199
Before you begin	199
Tractor-trailer combination pre-trip inspection — Class 1	200
1. Under hood	201
2. In cab	202
3. Air brake system test	204
4. Circle check for lights	205
5. Mechanical circle check	205
6. Brake response, tug and steering wheel slack tests	209
Single unit truck pre-trip inspection — Class 3	210
1. Under hood	211
2. In cab	212
3. Air brake system test	214
4. Circle check for lights	214
5. Mechanical circle check	215
6. Brake response, tug and steering wheel slack tests	217
Bus pre-trip inspection — Class 2 or Class 4 (unrestricted)	218
1. Engine compartment	219
2. In cab	220
3. Circle check	222
4. Passenger compartment check	224
5. Brake response, tug and steering wheel slack tests	224
Passenger vehicle pre-trip inspection — Class 4 (restricted)	225
1. Under hood	225
2. In passenger compartment	226
Start engine, check the following:	226
3. Circle check	227
4. Brake response tests	228

Pre-hill inspections	228
In-service brake checks.....	229
En route inspections	229
Post-trip inspections	230
Lights and reflectors	230
Review questions	232
Chapter 11: signs, signals and road markings	233
Signs	233
Regulatory signs	234
School, playground and crosswalk signs.....	235
Lane use signs	235
Turn control signs	236
Parking signs.....	236
Reserved lane signs.....	236
Warning signs	237
Object markers.....	238
Construction signs.....	239
Information and destination signs.....	239
Railway signs.....	240
Signals	240
Lane control signals.....	240
Traffic lights.....	241
Road markings	242
Yellow lines	242
White lines	243
Reserved lane markings	244
Other markings.....	244
Review questions	245
12: industrial roads	247
What you'll learn	247
Industrial air brake endorsement	248
How to apply for an industrial air brake endorsement	248
Driver's duty to inspect vehicles	248
Reporting defects.....	249
Brakes	249
Brake test	249
Water cooled brakes	249
Parking	249
Driving on industrial roads	249
Speed	250

Right-of-way.....	250
Warning signals	250
Railway crossings	250
Safety tips	250
Highway crossing permits	250
Review questions	251
Chapter 13: for more information	253
Dangerous goods	253
In case of an emergency	253
Federal contacts	253
Canadian Transport Emergency Centre (CANUTEC)	253
Transport Canada	254
Environment Canada	254
Commercial vehicle information	254
Commercial vehicle safety and enforcement	254
Report commercial vehicle safety violations	254
Commercial vehicle permit line.....	254
Dangerous goods inspectors	255
Dangerous goods head office	255
Metro Vancouver/Fraser Valley	255
Interior	255
Northern Region	255
Passenger transportation branch	255
Licensing information	255
Driver licensing.....	255
Booking road tests	255
Medical qualifications	256
More information	256
ICBC Prorate.....	256
ICBC Tip Line.....	256
Acts and regulations	256
National Safety Code	256
Other acts and regulations	257
Travel information	257
Road reports (B.C.)	257
Weather	257
Travelling into the U.S.	257
Canada Customs	257
B.C. Ferries.....	258
Tourism B.C.	258
Reporting forest fires	258

TaxiHost	258
Metric conversion table	259
Index	261
Examiners' tips for passing the Class 1, 2, 3 and 4 road tests	272
What to take to the driver licensing office	inside front cover
For the knowledge test you need	inside front cover
For the road tests you need	inside front cover
Identification (ID)	inside back cover
New to BC?	inside back cover
Has your name changed since birth?	inside back cover

introduction

Operating commercial vehicles or vehicles equipped with air brakes requires special knowledge and skill, and the cost of a mistake can be very high. When large vehicles are involved in crashes, the damage — to vehicles, cargo and human lives — can be catastrophic. Almost all these crashes are preventable and you can help ensure they don't happen.

ICBC, government and the commercial transport industry are working together to reduce the number and the severity of crashes. You have the most important role in preventing crashes, since most are caused by driver error.

Driving commercial vehicles give you the information you need to apply for a Class 1, 2, 3 or 4 commercial licence, or an air brake endorsement, industrial air brake endorsement or heavy trailer endorsement. To become a professional driver, you'll need to learn and practise the skills described in this guide.

This guide also includes information and tips on fuel-efficient driving habits and practices that can reduce fuel consumption and emissions.

Skill and ability alone aren't enough. You also need a professional attitude when you sit behind the wheel. Your safety and the safety of others will depend on your knowledge, attitude and actions.

Using this guide

This guide contains the basic information you need to take the tests you must pass to qualify for a commercial licence, an air brake endorsement, an industrial air brake endorsement or a heavy trailer endorsement (code 20). It's also designed to be used as a source text — if you're taking an approved air brake course. Air brake courses are available throughout B.C.

The tests you take will depend on the class of licence or endorsement you want.

This guide can provide you with information on how to drive and information on air brake systems but it's not a training manual. Once you have your learner's licence, you may begin gaining the practical experience you'll need to pass the required road test. You must spend time operating the type of vehicle you want to be licensed for. You'll also need instruction from an appropriately licensed driver or from a professional driver training facility. You may find additional helpful information in manufacturer's books, such as your vehicle's transmission guide, and in other reference material on operating commercial vehicles.

Inside this guide

The **table of contents** should help you find information easily. In each chapter we've included examples and tables, as well as **definitions, fast facts and driving tips** to make the information as clear and easy to use as possible.

You'll also find a 'what you'll learn' section at the beginning of each chapter. **What you'll learn** provides a detailed breakdown of what's covered in each chapter. You can also go back to it after you've studied the chapter and use it as a checklist to determine how well you've learned everything covered. Also, you'll find **Review questions** at the end of most chapters. You may want to use them as you prepare for your test.

Licence study chart

This table will help you focus on the chapters you'll need to prepare for your test.

If you're applying for:		Study these chapters:											
Class 1 licence *		1	2	3	4	5	6	7	8	9	10	11	
Class 2 licence		1	2	3	4	Pages 110 – 111	6	7	8 [†]	9 [†]	10 [†]	11	
Class 3 licence or heavy trailer endorsement (code 20)		1	2	3	4	5		7	8 [†]	9 [†]	10 [†]	11	
Class 4 licence		1	2	3	4	Pages 110 – 111	6	7	8 [†]	9 [†]	10 [†]	11	
Single-unit air brake endorsement [†]		1	2						8 [†]	9	10 [†]		
Industrial air brake endorsement ^{††}	Code 18	1	2						8 [†]	9	10 [†]		12
	Code 19	1	2						8	9	10		12

* If you are applying for a Class 1 licence with an air brake endorsement, you must study all of the chapters indicated. The Class 1 knowledge test includes all air brake knowledge test material for this class of commercial licence. You are not required to take the single-unit air brake knowledge test.

† If you are applying for a single-unit air brake endorsement for a Class 2, 3, 4, 5 or 7 licence, study:

- all of chapters 1, 2 and 9
- all of chapter 8, **except** pages 166 to 169, and 171 to 172
- all of chapter 10, **except** pages 200 to 209

If you are only attempting a Class 2, 3, or 4 knowledge test and not taking the single-unit air brake knowledge test at the same time, the content from chapters 8 and 9 is not required reading.

†† If you are applying for an industrial air brake endorsement Code 18 or Code 19 to be added to your licence, you are not required to complete a knowledge test. You may study the chapters indicated to help you prepare for your air brake pre-trip inspection test. **Note:** for Code 18, study the same chapters and pages as for the single-unit air brake endorsement, as well as chapter 12.

1

getting your driver's licence

warning

Driving without a valid driver's licence or correct class of licence may breach your insurance coverage if you're in a crash. Your insurance claim may be denied, including claims for your own injuries, or damage that you might cause to your vehicle, or to other people or property. You could be responsible for paying these costs.

Need more information? Call 1-800-950-1498 or go to icbc.com.

fast fact

You must hold a full-privilege Class 5 or equivalent licence before you can apply for a commercial licence, a heavy trailer endorsement, or a house trailer endorsement.

This chapter tells you how to apply for a Class 1, 2, 3 or 4 licence.



What you'll learn

After studying this chapter you'll be able to:

- describe B.C.'s driver licence classes
- know which vehicles require an air brake endorsed driver's licence
- describe the steps to get a commercial driver's licence, an air brake endorsement or a heavy trailer endorsement.

Licence classes

For more information, check icbc.com or contact your local driver licensing office.

Class	Vehicle type	Minimum age
Class 1 	<ul style="list-style-type: none">• Semi-trailer trucks and all other motor vehicles or combinations of vehicles except motorcycles.	19
Class 2 	<ul style="list-style-type: none">• Buses, including school buses, special activity buses and special vehicles.• Trailers or towed vehicles may not exceed 4,600 kg — may exceed 4,600 kg only if bus and trailers do not have air brakes.• Any motor vehicle or combination of vehicles in Class 4.	19
Class 3 	<ul style="list-style-type: none">• Trucks with more than two axles, such as dump trucks and large tow trucks, but not including a bus that is being used to transport passengers.• Trailers or towed vehicles may not exceed 4,600 kg — may exceed 4,600 kg only if truck and trailers do not have air brakes.• A tow car towing a vehicle of any weight.• A mobile truck crane.• Any motor vehicle or combination of vehicles in Class 5.	18

definitions

A **special activity bus** is operated for a school, and doesn't run on a set schedule.

A **special vehicle** has a seating capacity of 10 or fewer people (including the driver), and is designed or modified to provide public transportation for people with disabilities.

driving tip







For more information on towing recreational trailers and getting a house trailer endorsement, see *Towing a recreational trailer* on icbc.com.

fast fact

Ride-hailing, also known as transportation network services (TNS), connects drivers to passengers who book and pay online through an app.

definition

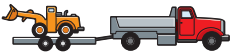
Construction vehicles include tractors, graders, loaders, shovels, rollers, scrapers or other self-propelled road building machine used for highway grading, paving or other construction work. Trucks, truck-tractors, mobile truck cranes or truck-mounted backhoes with three or more axles aren't included.

Class	Vehicle type	Minimum age
Class 4 (unrestricted) 	<ul style="list-style-type: none"> Buses with a maximum seating capacity of 25 persons (including the driver), including school buses, special activity buses and special vehicles used to transport people with disabilities. Taxis, limousines and ride-hailing vehicles. Ambulances. Any motor vehicle or combination of vehicles in Class 5. 	19
Class 4 (restricted) 	<ul style="list-style-type: none"> Taxis, limousines and ride-hailing vehicles (up to 10 persons including the driver). Ambulances. Special vehicles with a seating capacity of not more than 10 persons (including the driver) used to transport people with disabilities. Any motor vehicle or combination of vehicles in Class 5. 	19
Class 5 or 7* 	<ul style="list-style-type: none"> Two-axle vehicles including cars, vans, trucks and tow trucks. Trailers or towed vehicles may not exceed 4,600 kg. Motorhomes (including those with more than two axles). Limited-speed motorcycles** and all-terrain vehicles (ATVs). Passenger vehicles used as school buses with seating capacity of not more than 10 persons (including the driver). Construction and utility vehicles. Three-wheeled vehicles — does not include three-wheeled motorcycles (trikes) or motorcycle/sidecar combinations. Does not include Class 4 vehicles or motorcycles. 	16
Class 6 or 8* 	<ul style="list-style-type: none"> Motorcycles, all-terrain cycles, all-terrain vehicles (ATVs). 	16
Class 4 or 5 with heavy trailer endorsement (code 20) 	<ul style="list-style-type: none"> Trailers or towed vehicles exceeding 4,600 kg provided neither the truck nor trailer has air brakes. Any motor vehicle or combination of vehicles in Class 5. 	18
Class 4 or 5 with house trailer endorsement (code 07 – formerly code 51) 	<ul style="list-style-type: none"> Recreational (house) trailers exceeding 4,600 kg provided neither the truck nor trailer has air brakes. Any motor vehicle or combination of vehicles in Class 5. 	18

* Drivers in B.C.'s Graduated Licensing Program are issued Class 7 and/or Class 8 driver's licences.

** Limited-speed motorcycles can be operated with any class of driver's licence. See icbc.com for more information.

Medical fitness

Commercial drivers need to be in good physical condition. When you apply for a commercial driver's licence, heavy trailer endorsement or industrial air brake endorsement you'll:

- be asked if you have certain medical conditions that may affect your fitness and ability to hold a commercial driver's licence.
- be required to complete a declaration form regarding medical conditions.
- be given a Driver's Medical Examination form that your doctor needs to complete and send to RoadSafetyBC. The Superintendent will review the information on the form to determine your fitness to hold a commercial driver's licence.
- be required to complete a vision screening (see below for details).

If you've any questions about a medical condition and whether it may affect your fitness to hold a commercial driver's licence, contact RoadSafetyBC.

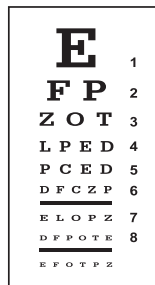

Vision

Commercial drivers are required to meet a higher vision standard than Class 5 drivers. Your vision will be screened at a driver licensing office when you apply for a learner's licence. If a problem is found, you may be required to have your eyes examined by an ophthalmologist or optometrist.

Your vision will be checked to measure:

- your ability to read from a distance (visual acuity)
- your ability to see objects on each side of you (peripheral vision)
- your ability to tell how close objects are (depth perception)
- whether you have double vision (diplopia)
- your ability to distinguish red, green and amber (colour perception).

fast fact

Applicants who need contact lenses or eyeglasses to meet the required vision standards must use those lenses during their vision screenings.

fast fact

An applicant who fails to qualify on the air brake knowledge test after three attempts must complete or repeat an approved 7-hour air brake training course.

The air brake knowledge test results are only valid for one year. Drivers who haven't had the air brake endorsement placed on their driver's licence within one year of passing the air brake knowledge test will need to re-take it.

Air brake endorsement

To operate vehicles equipped with air brakes on a highway (other than a vehicle defined as a construction vehicle), you must have a B.C. driver's licence with an air brake endorsement (code 15).

An air brake endorsement is also required to operate most vehicles equipped with air-over-hydraulic brakes. See **chapter 8, air brakes**, for details about this type of braking system.

Endorsement code 15 is shown in the "restrictions" section of a driver's licence.

How to apply for an air brake endorsement

1. Complete an air brake course. These are a minimum of 7 hours in length and are available at many driving schools, community colleges and other sites. When you complete the course, you'll be given a certificate or other proof of course completion.
2. Study the applicable sections of this guide to prepare for the air brake endorsement tests.

3. Apply for an air brake endorsement at a driver licensing office. You'll need to:
 - present primary and secondary identification (acceptable identification is listed on the inside back cover)
 - provide proof of air brake experience (for example, an air brake certificate showing that you have completed an air brake course)
 - pay the knowledge test fee
 - take the air brake knowledge test.
4. Make an appointment to take the air brake pre-trip inspection test.
5. Take your air brake pre-trip inspection test. A road test is not required. You'll need to bring a vehicle equipped with air brakes to take this test.

Note: You must bring the same type of identification used to apply for your air brake endorsement (see Step 3).
6. You'll receive a temporary licence with an air brake endorsement after passing all of the tests and paying the fee for your new driver's licence. Your new photo licence will be mailed to you.

fast fact

You must provide proof that you have an acceptable driving record before you can get a commercial class driver's licence.

If you have held a B.C. driver's licence for the past three years, ICBC will check your B.C. driving record to confirm that you have an acceptable driving record.

If you have held a driver's licence from another jurisdiction during the past three years, you'll need to get a driver's abstract from that jurisdiction.

For more information about getting an acceptable abstract, call ICBC at 1-800-950-1498.

fast fact

Every carrier you work for is required to check your driving record before hiring you and once a year after hiring you.

How to apply for a Class 1, 2, 3 or 4 driver's licence

Commercial drivers must meet a high standard. Before you begin the application process, you must meet these prerequisites:

- hold or have held a full-privilege licence that is a minimum of a Class 5 or Class 6, or an out-of-province equivalent
- have an acceptable driving record that shows:
 - fewer than four offences that carry penalty points in the previous two years
 - zero motor-vehicle-related Criminal Code convictions in the previous three years
- meet the minimum age requirements (see Licence classes chart)
- have no outstanding fines or debts owed to the Court, the Government or ICBC including outstanding liquor fines, tolls and arrears with the B.C. Family Maintenance Enforcement Program
- meet the required medical standards (see details later in this chapter).

These steps outline the process of applying for a commercial licence:

1. Study the applicable chapters of this guide to prepare for the knowledge test.
2. Apply for a learner's licence at a driver licensing office.
 - You'll need to present one piece of primary and one piece of secondary identification (see inside of back cover)
 - We'll check your driving record to ensure you've no more than the allowed number of penalty points in the past two years and no motor-vehicle-related Criminal Code convictions in the past three years
 - You'll need to pay the knowledge test fee and take the knowledge and road signs tests

fast fact

The licensing process to obtain a Class 1, 2, 3 or 4 driver's licence, a heavy trailer endorsement, house trailer endorsement or an air brake endorsement is conducted entirely in English. You must be able to communicate in both spoken and written English without assistance.

fast fact

For more information on medical and vision standards, contact RoadSafetyBC. For the phone number, see **chapter 13, for more information.**

- We'll conduct a vision and medical screening. You'll be asked questions relating to your medical health — you must disclose any known medical conditions.
3. You'll receive your learner's licence after successfully completing all of Step 2, unless you have a medical condition that requires pre-approval. The learner's licence is valid for one year and allows you to practise driving with a supervisor. The supervisor must be at least 19 years old and hold the appropriate licence for the vehicle you're practising on (for example, hold a Class 1 driver's licence if you're practising on a Class 1 tractor-trailer combination). The supervisor must sit beside you or immediately behind and to the right if there's no seat beside the driver's seat.

When operating a bus, taxi, ride-hailing vehicle or ambulance with a learner's licence, no passengers permitted other than your supervisor and other learners being trained to operate the same class of vehicle and who hold the same class of learner's licence.

4. Practise with an appropriately licensed driver and/or attend a driver training school.
5. When you're ready, phone your driver licensing office to schedule your road test. Be sure to ask about the type of vehicle you must bring for your road test. You should also ask how your vehicle must be loaded.
6. Take your road test, which includes a pre-trip inspection test (and an air brake pre-trip inspection test if your vehicle has air brakes).

Note: You must bring the same type of identification you used to apply for your learner's licence (Step 2) and the fee for your road test.

7. Pay the fee for your new driver's licence. You'll receive a temporary licence after you pass all your licensing tests. You'll also be given a Driver's Medical Examination Report form.
8. Take the medical form to a B.C.-licensed physician who knows your medical history. The doctor who examines you completes the form and sends it to RoadSafetyBC. RoadSafetyBC will determine whether you're fit to drive commercial vehicles.

Note: The doctor's fee for completing a routine medical form is not covered by the Medical Services Plan of B.C., ICBC or RoadSafetyBC.

How to apply for a heavy trailer endorsement

A heavy trailer endorsement (code 20) for a Class 4 or 5 driver's licence allows you to tow trailers of any weight provided that neither the truck nor trailer has air brakes. To apply for the endorsement:

1. Study the applicable chapters of this guide to prepare for the knowledge test.
2. Apply for a learner's licence at a driver licensing office.
 - You'll need to present one piece of primary and one piece of secondary identification as listed (see inside of back cover)
 - You'll need to pay the knowledge test fee and take the knowledge and road signs tests
 - We'll conduct a vision and medical screening. You'll be asked questions relating to your medical health — you must disclose any known medical conditions.

3. You'll receive your learner's licence after you successfully complete all of Step 2, unless you have a medical condition that requires pre-approval. The learner's licence is valid for one year and allows you to practise driving with a supervisor. The supervisor must be at least 19 years old, hold a Class 1, 2 or 3 driver's licence, and must sit beside you or immediately behind and to the right if there's no seat beside the driver's seat while you're practising.
4. Practise with an appropriately licensed driver and/or attend a driver training school.
5. When you're ready, phone your driver licensing office to schedule your road test. Be sure to ask about the type of vehicle you must bring for your road test.
6. Take your road test, which includes a pre-trip inspection test.

Note: You must bring the same type of identification you used to apply for your learner's licence (Step 2) and the fee for your road test.

7. Pay the fee for your new driver's licence. You'll receive a temporary licence after you pass all your licensing tests. You'll also be given a Driver's Medical Examination Report form.
8. Take the medical form to a B.C.-licensed physician who knows your medical history. The doctor who examines you completes the form and sends it to RoadSafetyBC. RoadSafetyBC will determine whether you're fit to drive commercial vehicles.

Note: The doctor's fee for completing a routine medical form isn't covered by the Medical Services Plan of B.C., ICBC or RoadSafetyBC.

9. You'll receive your photo licence in the mail once your medical fitness is confirmed.

fast fact

For more information on medical and vision standards, contact RoadSafetyBC. For the phone number, see **chapter 13, for more information.**

Knowledge tests

You need to take knowledge tests whenever you apply for a new licence. All knowledge tests referred to in this guide are conducted only in English. You must be able to complete these tests without assistance. The tests are all multiple choice. The answers to all the knowledge test questions are in this guide.

One of the knowledge tests is a traffic signs test. To prepare for this test, review the signs shown in **chapter 11, signs, signals and road markings**, as well as the signs shown in other chapters of this guide.

Refer to the licence study chart on page 2 to learn which chapters of this guide you should study.

Road testing

When you're ready to take a road test, call your local driver licensing office to book a road test appointment. Refer to **chapter 13, for more information**, for toll-free telephone numbers.

When you book your appointment, be sure to ask what type of vehicle you must bring for your road test and how your vehicle must be loaded. If your vehicle is equipped with air brakes, remember to bring the necessary tools and equipment to do a brake adjustment.



fast fact

Knowledge and road test fees vary depending on which tests you will be taking. The fees are listed at icbc.com.

fast fact

You're responsible for ensuring that your vehicle is properly insured for use during your road test. ICBC accepts no liability whatsoever for ensuring that your vehicle is properly insured and expressly reserves its right to make determinations with respect to coverage in the event of a claim. Check with your Autoplan broker if you have any questions about your coverage.

fast fact

The National Safety Code sets out minimum safety standards for all commercial drivers, vehicles and carriers in Canada.

All road tests consist of:

- a pre-trip inspection
- an air brake pre-trip inspection (if your vehicle is equipped with air brakes)
- a road test.

During your road test you must demonstrate your ability to:

- do a pre-trip inspection, including a written trip inspection report
- use basic skills for controlling your vehicle
- handle your vehicle in traffic.

A Class 1 road test takes about two hours. Class 2, 3, 4 and heavy trailer endorsement road tests take fewer than two hours.

Plan to arrive at the office at least 15 minutes early. If you can't keep your road test appointment, you need to notify ICBC.

You'll have to pay a fee if you don't show up for your scheduled road test and don't provide either 48 hours notice or a valid reason for not attending.

Pre-trip inspection test

The National Safety Code (NSC) requires most commercial drivers to complete trip inspections. If you're applying for a Class 1, 2, 3 or 4 licence, a heavy trailer endorsement, a house trailer endorsement or an air brake endorsement, you'll need to conduct a pre-trip inspection. If you're applying for a Class 1, 2, 3 or 4 unrestricted licence, you must also complete and submit a written trip inspection report.



If your vehicle is equipped with air brakes with manual slack adjusters you'll need to perform a brake adjustment as part of the test. Make sure you have the proper tools to carry out this adjustment.

The pre-trip inspection part of your road test is your opportunity to show that you know how, when and why you must complete a trip inspection. Under the NSC, pre-trip inspections must always be done before the first run of the day. Even if you conducted a pre-trip inspection earlier in the day, your driver examiner will ask you to do a pre-trip inspection as part of your road test.

During the inspection, tell your examiner what you are checking for and how you know if each part of your vehicle is in good working order. You'll get a trip inspection report to fill out as part of your pre-trip inspection.

You can find more about pre-trip inspections and pre-trip inspection tests in **chapter 10, vehicle and air brake pre-trip inspections**.

Road test

You must be able to demonstrate these skills competently during your road test:

- starting and stopping
- shifting gears
- turning
- steering
- backing up
- parking
- merging with highway traffic
- exiting from highways
- driving in traffic
- coupling and uncoupling a tractor unit from a trailer — for a Class 1 road test or heavy trailer endorsement (code 20).

During your road test, concentrate on the traffic and don't think about what your examiner may be recording.

Road test vehicles

You need to provide an appropriate vehicle when you take your road test. Make sure that the vehicle meets safety standards, and that valid registration, licence and insurance papers are in the vehicle.

The vehicle must be representative of the licence class. The following are typical vehicles accepted for road tests:

- Class 4 (restricted) — any car or pickup truck
- Class 4 (unrestricted) — a full-sized passenger van or small school bus with a seating capacity of at least 11 adults
- Class 3 — a large tandem or tridem rear axle truck such as a moving van or dump truck
- Class 2 — a large bus with a seating capacity of at least 36 adults
- Class 2 - a bus with a seating capacity of 25-34 adults (NOT including the driver); Restriction 51 "CL2 max 34 pass. capacity" will be added.
- Class 1 — a loaded tandem or tridem rear axle tractor trailer combination with air brakes and with an on-road loaded weight of at least 28,000 kg. Semi-trailer must be at least 13 metres long (7.5 metres if pintle hitch trailer).
- Heavy trailer endorsement (code 20) — a loaded truck and trailer combination without air brakes. The trailer with its load must weigh at least 4,600 kg.

fast fact

If you're taking a road test in an air-brake-equipped vehicle, you must have an air brake endorsement on your driver's licence or have taken an approved air brake course and passed the knowledge test.

fast fact

If you take your Class 1, 2 or 3 road test using an automatic transmission, your Class 1, 2 or 3 driver's licence will be restricted to automatic transmissions only.

fast fact

The Ministry of Transportation and Infrastructure may post seasonal restrictions limiting axle weight on certain roads or highways districts. If there's a restriction in effect where and when you'll be taking your road test, the weight of the vehicle used for the road test, including its load, must not exceed the seasonal weight restriction.

For example, if seasonal restrictions limit loads to 50 per cent of legal axle weight, a five-axle tractor/combination with a total maximum legal axle weight of 40,500 kg would be restricted to no more than 20,250 kg.

Check with a driver licensing office for specific vehicle requirements.

If the vehicle's carrying a load, make sure that it's properly secured and won't escape, shift or sway.

Commercial vehicles used for road tests may not contain the following:

- dangerous goods or explosives
- unbaffled liquids or dry bulk
- livestock
- oversized loads.

The load must not exceed the vehicle's GVWR or licensed GVW, and in the case of a Class 1 or heavy trailer endorsement road test, must meet minimum weight and load requirements.

See **chapter 5, skills for driving trucks and trailers**, for definitions of GVW and GVWR.

For more information on acceptable vehicles for taking a road test, contact a driver licensing office.

Strategies to ensure your vehicle is safe

You need to provide a safe, reliable vehicle that meets legal requirements and is acceptable for the class of licence you're applying for. Also, make sure you're familiar with the vehicle.

If your vehicle is unsafe or does not meet requirements, your road test may be cancelled and you will have to reschedule your appointment to a later date. Here is a list of some of the typical reasons that a Class 1 to 4 road test may be cancelled. Avoid disappointment — conduct a pre-trip inspection of the vehicle to find and correct any defects before going for your road test:

1. **Brake lights, signal lights or headlights not working, obscured by mud or dirt, or badly cracked or missing lenses** — these lights help you to be seen in traffic, so they need to be clean and function properly.
2. **Air brakes out of adjustment** — make sure the brakes are in good working order and properly adjusted.
3. **Cracked windshield or illegally tinted windows** — it's important that you and the driver examiner be able to see out the windshield, so a badly cracked windshield just won't do. Tinted windows may reduce your ability to see other road users — and their ability to make eye contact with you. B.C. law only allows certain windows and only certain portions of the windshield to be tinted and limits the degree of tinting — no aftermarket tinting on the windshield or front side windows is allowed.
4. **Insecure load** — make sure the load is properly secured. For Class 1 and code 20 heavy trailer endorsement road tests, the vehicle must be loaded and meet minimum load requirements.
5. **Vehicle not properly licensed or insured** — B.C.-licensed vehicles must display a valid licence plate and insurance decal. They must be clearly visible, not obscured by mud or dirt. Make sure the insurance papers are in the vehicle — with a combination vehicle, make sure both the tractor and trailer insurance and registration papers are on hand. Also make sure

the insurance covers you to drive the vehicle (if you are renting a vehicle, the rental agreement must name you as a driver). Make sure there is a CVIP inspection decal and report in the vehicle, if required.

6. **Seatbelts not working or frayed** — for your road test, make sure both the driver and passenger seatbelts work properly, and that the seating area is clean.
7. **Unsafe tires** — make sure the tires are in good condition, have plenty of tread, are properly inflated, and there are no flat tires. Temporary spare tires may not be used on a road test (they are intended only to get the vehicle to the nearest repair shop at reduced speeds so that the proper tire can be repaired or replaced).
8. **Doors or windows not operating** — for safety reasons both the driver's side and passenger side doors must open and close properly, from both the inside and the outside. There are times on the road test that you or the driver examiner may need to open a window, so they need to function properly.
9. **Faulty exhaust** — a leaking exhaust pipe or missing muffler is unsafe and dangerous — it may cause carbon monoxide poisoning. Excessively loud mufflers are illegal and interfere with conducting your road test.
10. **No wheel blocks** — these are required to safely secure large commercial vehicles to conduct a pre-trip inspection.

Also, remember to bring tools and equipment to conduct the pre-trip inspection, including wrenches, a pry bar, chalk or marker, and a watch/timer to check air brakes. You should also wear sturdy clothing, a hard hat, eye protection, boots, and a safety vest.

As well, make sure your vehicle is clean and tidy inside, and that lights and windows are clean.

Loose objects inside can be dangerous if you have to stop suddenly, so these should be removed or stored.

Retest

If you fail any of your tests see the inside cover at the front of this guide for the standard waiting periods between retests. Visit icbc.com for the contact phone numbers to book commercial road tests.

Commercial driver training

Becoming a safe commercial driver requires both education and practical experience. You may decide that driver training will help you to get the necessary knowledge and skills.

Driver training instructors must meet ICBC licensing and testing standards before they receive a licence to provide driving instruction.

Check that the driver training school licence and the licence of each driver training instructor employed by the facility is displayed at the school's office. Each school must also post a bond for the financial protection of their students.

warning!

Driving School Code of Conduct

ICBC expects all Driver Training Schools and instructors to comply with our Code of Conduct, which sets out principles and guidelines for them to operate in a lawful and ethical manner.

ICBC licensed Driving Schools deliver professional training and are expected to provide a safe environment for their students and conduct themselves with dignity and respect for all persons.

Learn more about our Driving School Code of Conduct at icbc.com/DScodeofconduct.

driving tip

To find an air brake course, check online or in the yellow pages of the phone book under Driving Schools. Many community colleges also offer these courses.

fast fact

The National Safety Code requires all Class 1, 2, 3 and 4 drivers and drivers with a code 18 or 19 industrial air brake endorsement or code 20 heavy trailer endorsement to submit a Driver's Medical Examination Report regularly.

You'll be sent a Driver's Medical Examination Report form for completion by your doctor at ages:

- 25, 30, 35, 40 and 45
- 48, 51, 54, 57, 60 and 63
- every year upon reaching the age of 66.

The doctor's fee for completing this routine medical report is not covered by the Medical Services Plan of B.C., ICBC or RoadSafetyBC.

Air brake courses

An air brake course is highly recommended as even experienced drivers learn more about air brakes by taking the course.

To apply for an air brake endorsement, you'll need to provide proof that you've completed an air brake course. There are two types of air brake courses:

- A **certified course** includes 7 hours of classroom theory on air brake systems along with four hours of practical training on conducting an air brake pre-trip inspection. If you pass an air brake pre-trip assessment conducted by the course provider, you may not need to take an air brake pre-trip inspection test conducted by an ICBC driver examiner in order to obtain an air brake endorsement.
- A **non-certified course** (completed at a licensed driver training school or college) includes 7 hours of classroom theory on air brake systems.

You may be exempt from taking an air brake course if you can prove you have enough air brake experience. Contact a driver licensing office for more information.

Even if you're exempted from the air brake training course, you'll need to pass the air brake knowledge test and the air brake pre-trip inspection test. If you don't pass these tests, you may have to complete an air brake course before you take any further tests.

Keeping your licence

RoadSafetyBC will require you to take medical exams on a regular schedule as long as you hold a commercial driver's licence.

If you have a medical condition that may affect your fitness to drive, you may need to take medical exams more frequently. The Driver's Medical Examination Report form is sent to you by regular mail. Your driver's licence may be cancelled if you don't submit this form.

You must also be re-examined when asked by RoadSafetyBC.

A re-examination may include a:

- vision screening
- knowledge test (which may include a traffic signs test)
- road test (including a pre-trip inspection).

fast fact

If you hold a higher class out-of-province licence, some tests may be waived. Please contact your nearest driver licensing office for details.

Commercial driver medical examination processing fee

This fee helps cover the Province's costs for processing commercial driver medical reports.

The fee is charged when you obtain or renew your commercial driver's licence or industrial air brake endorsement and is in addition to your photo driver's licence fee. If you hold a commercial driver's licence for volunteer purposes only, you may be exempt from paying this fee.

Upgrading your commercial licence

Once you have your commercial licence, you may want to upgrade to another licence class (for example, from a Class 3 to a Class 1, or a Class 2 to a Class 2/3). You'll need to follow all the steps for getting that licence, including applying for a learner's licence.

A supervisor with an appropriate class of licence must accompany you while you practise driving.

Downgrading to a non-commercial licence

If you want to downgrade to a non-commercial licence class (for example, from Class 1 to Class 5), you need to visit a driver licensing office to apply for a new licence.

Your driver's licence will not be downgraded if you fail to submit a routine Driver's Medical Examination Report form. If you have been sent a routine medical form to continue to hold a commercial class driver's licence and you want to downgrade, you must visit a driver licensing office to apply for a new licence.

Downgrading to a lower commercial licence class

If you want to downgrade your driver's licence classification (for example, from Class 1 to Class 2 or Class 3), you must meet the requirements of the lower licence classification. Please check with a driver licensing office for information.

Review questions

1. What kinds of vehicles require the driver to have an air brake endorsed driver's licence in order to operate them?
2. Which driver licence classes allow you to operate a school bus?
3. What are the steps to obtain an air brake endorsement?
4. What classes of licence or licence endorsements allow you to operate a trailer equipped with air brakes weighing over 4,600 kg?

definition

Heat is a form of energy. In an internal combustion engine, the heat energy produced by engine combustion is converted to the energy of **motion** through the moving parts of the engine and drive train, turning the wheels.

Even though the energy of motion turns the vehicle's wheels, the vehicle won't go anywhere unless there's **traction** between the tires and the road surface.

In stopping a vehicle, the energy of **motion** is converted to the energy of **heat** through **friction** between the lining/pad and drum/rotor surfaces of the vehicle's brakes.

fast fact

The final factor in stopping is in the contact between the vehicle and the road through the tires.

Bald or defective tires may degrade braking performance.

What you'll learn

After reading this chapter you'll be able to:

- explain why heavy vehicles take longer to stop than smaller passenger vehicles
- explain why air brakes are used on heavy vehicles
- describe the basic scientific principles of braking
- identify the elements of stopping distance
- explain the effects of weight and speed on stopping distance
- explain how to brake safely in different situations.

Starting and stopping

Stopping seems simple. When you drive a car and you want to stop, you press on the brake pedal and the car comes to a stop. And when you want to go somewhere in a car, you start it, press on the accelerator, and the car begins to move.

But what actually happens to cause the vehicle to stop? And what causes a vehicle to move? To answer these questions, we need to know some basic scientific principles.

Your car's engine, like the diesel engine of a truck, is a heat conversion machine, taking the energy of heat from the exploding mixture of fuel and air in the combustion chamber, and converting it to motion through the engine crankshaft and drivetrain to the wheels.

A brake — whether a brake for a car or a commercial vehicle — is also a heat conversion machine, but works exactly opposite to an engine. Brakes convert the energy of motion back into the energy of heat through the friction between the brake drums or rotors and the brake linings or pads.

A simple kind of brake is that used by a skater on rollerblades — the skater tips the rollerblade to the rear, and a pad rubs against the pavement to slow and stop the skater. The pad gets hot, and so does the pavement. This is because the energy of **motion** has been converted to the energy of **heat** through the **friction** between the pad and the pavement. Both the pad and the pavement need to be able to absorb the heat created while stopping.

A vehicle's brakes work on these same principles. Attached to each wheel is either a drum brake or a disc brake that rotates with the wheel. To stop the vehicle, brake linings rub against the brake drum, or in the case of disc brakes, brake pads rub against the brake rotor. This creates friction, converting the vehicle's energy of motion into the energy of heat, which stops the vehicle. The heat is absorbed and dissipated into the atmosphere, primarily through the brake drums/rotors.

The basic principle behind braking systems: friction converts the energy of motion to heat energy.

You might say the energy has gone full circle:

Heat Energy → **Energy of Motion** → **Heat Energy**
 (from the engine) → (through the drivetrain) → (through the brakes)

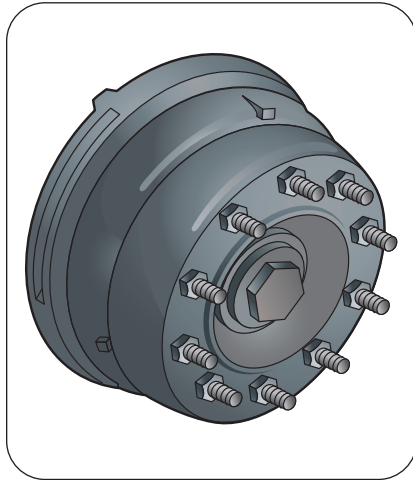

Drum brake



Disc brake

Power to move and power to stop

A typical compact car weighs about 1,000 kg and has about 120 hp. It can accelerate to 100 km/h within about 200 m and in less than 10 seconds.

A heavy tractor-trailer combination can weigh up to 63,500 kg when loaded. Even though it may have a diesel engine producing over 400 hp, because of the weight of the combination and its load, it might take over one kilometre and over one minute to accelerate to 100 km/h.

Now think about stopping a tractor-trailer combination that's going 100 km/h. How much energy is needed to stop it? You certainly want to stop it in a much shorter distance than one kilometre and in much less than one minute. In an emergency, the combination might have to stop in as little as seven seconds — roughly $\frac{1}{9}$ of the time it took to reach 100 km/h.

To stop the vehicle this quickly requires a stopping force of nine times the acceleration force — the equivalent of approximately 4,000 hp.

With a tractor-trailer combination equipped with eight equally loaded axles and 16 brakes, each brake has to provide approximately $\frac{1}{16}$ of the braking force. If one or two of these brakes isn't correctly adjusted, the others have to do more than their share of the braking, resulting in a longer stopping distance. If the axles are not equally loaded, wheels with lighter loads may skid, also resulting in a longer stopping distance.

The other brakes would also have to work harder and that might be more work than they're manufactured to do. Excessive use of the brakes could result in a buildup of more heat than the brakes can absorb and dissipate. Too much heat can result in brake damage and possible failure.

fast fact

Reaction time is the time it takes between recognizing a hazard ahead and applying the brakes.

An average driver's reaction time is about $\frac{3}{4}$ of a second.

definition

Driver's perception time
 + reaction time
 + brake lag time
 + braking time
 = total stopping time

driving tip

Total stopping time will be even longer if brakes are incorrectly adjusted or vehicle is on a downgrade.

The most common air brake system defect found during a commercial vehicle inspection is brakes that are out of adjustment.

driving tip

Total stopping distance or time depends on the ability of the brake linings or pads to produce friction, the brake drums to dissipate heat and the tires to grip the road.

Total stopping distance includes perception time, reaction time, brake lag time and braking time.

Always allow enough following distance or time and choose a speed that will allow you to stop safely.

Stopping distance and stopping time

To stop a vehicle, you need to **see-think-do**. Total stopping distance is the distance your vehicle will travel from the moment you do:

- **see** — a hazard
- **think** — decide to stop
- **do** — place your foot on the brake pedal until you stop.

This distance can also be expressed as the time it takes to stop.

When you see a problem ahead while driving, it'll take you about $\frac{3}{4}$ of a second of **perception time (see-think)** and another $\frac{3}{4}$ of a second of **reaction time (do)**. Only then will your vehicle begin to slow.

A car's brakes begin to work almost instantly when you press on the brake pedal. This is not the case with air brakes because there's a **brake lag time** of approximately $\frac{4}{10}$ of a second between when you apply the brake and when the brakes begin to function. Add to this the **braking time**, which is the time — or distance — the vehicle travels before it stops.

This is why it's so important to allow enough distance when following other vehicles.

Passenger cars and light truck drivers should use the two-second rule. Watch the vehicle ahead pass some checkpoint on the roadway, such as an overpass or sign post. Start to count: "One thousand and one, one thousand and two." That's two seconds.

Drivers of buses, trucks and other large heavy vehicles should never be less than five seconds behind the vehicle ahead at highway speeds.

Refer to **chapter 3, basic driving skills**, for more information on following distance.

Stay even further back when conditions are less than ideal.

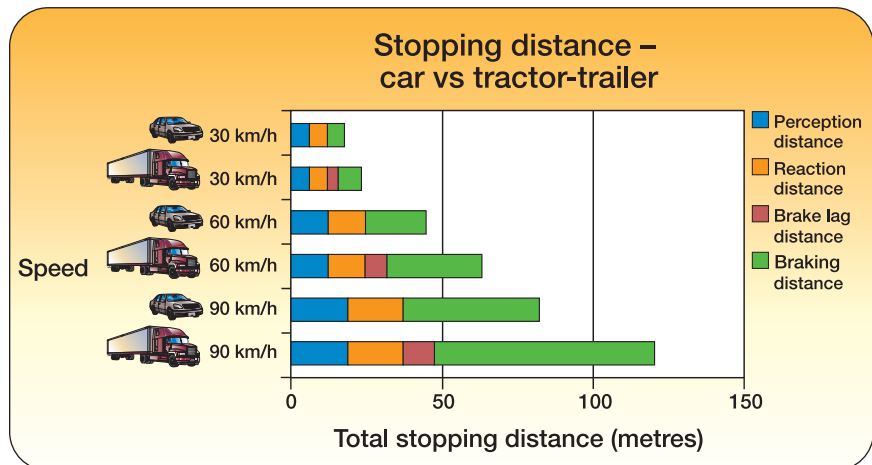

fast fact

Driving without due care and attention and unsafe speed are the top two factors assigned to commercial drivers involved in police-reported casualty crashes.

Traffic Collision Statistics: British Columbia (2007)

Speed and weight facts

Speed and weight affect the stopping power required to stop any vehicle, and how far it will travel before it stops. You need more stopping power whenever the speed you're travelling and/or the weight of your vehicle increases:

- 2 X vehicle speed requires 4 X the stopping power
- 2 X vehicle weight requires 2 X the stopping power
- 2 X vehicle speed and 2 X vehicle weight requires 8 X the stopping power.

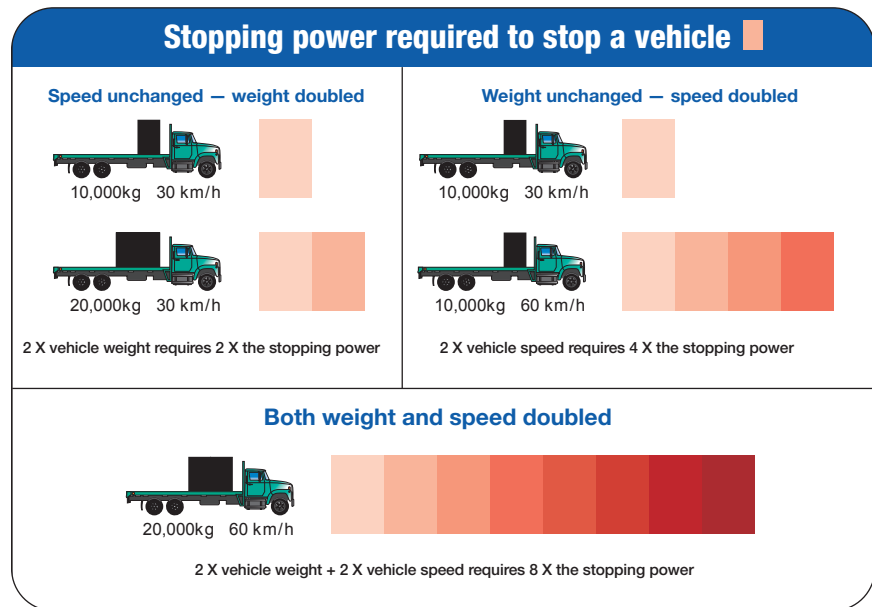

A typical compact car weighs about 1,000 kg. The truck in the illustration above may weigh 25,000 kg when fully loaded — over 25 times heavier than a car. And heavy tractor-trailer combinations can weigh up to 63,500 kg.

There's only so much stopping power available, and the faster the vehicle is travelling, the more power it needs to stop. This is why it's so important to drive at a safe speed, at a safe following distance, and within the vehicle's stopping capability.

Compared to cars, trucks and buses have larger brake components, more wheels and more brake linings/shoes or rotors/pads. But trucks and buses have longer stopping distances.

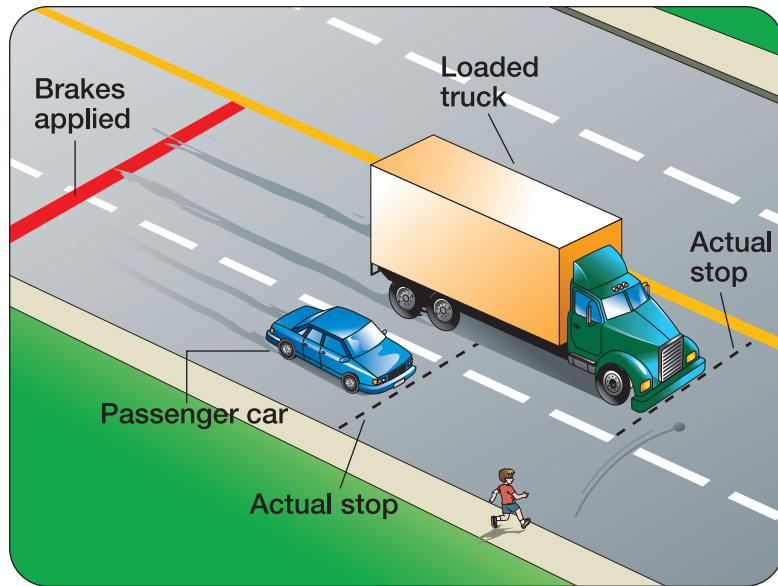

The truck is going to take much longer to stop than the car — even more so if going downhill.

Another factor in stopping distances is the slope or grade of the road. A vehicle travelling down a hill will need a longer stopping distance than a vehicle travelling at the same speed on a level surface because of the effect of gravity. A vehicle travelling up a hill will stop in a shorter distance than a vehicle travelling the same speed on a level surface, again because of the effect of the grade.

How much heat can brakes handle?

definition

Brake fade occurs when your brakes stop working properly because they're overheated. Your vehicle takes longer to stop, or may not stop at all if you haven't properly controlled the speed.

In normal stopping, the brake components heat up to about 120° C (almost 250° F). The brake components are constructed to withstand more heat, and can handle up to about 250° C under hard braking.

Heat will continue to build up with excessive hard braking until it exceeds the capability of the brake components to absorb and dissipate the heat. As brake drums heat up, they expand away from the brake linings. Too much heat can result in brake fade, brake damage and/or brake failure. Brake components or tires may actually catch fire.

Most brake components operate best at around 120° C and should not exceed 250° C.

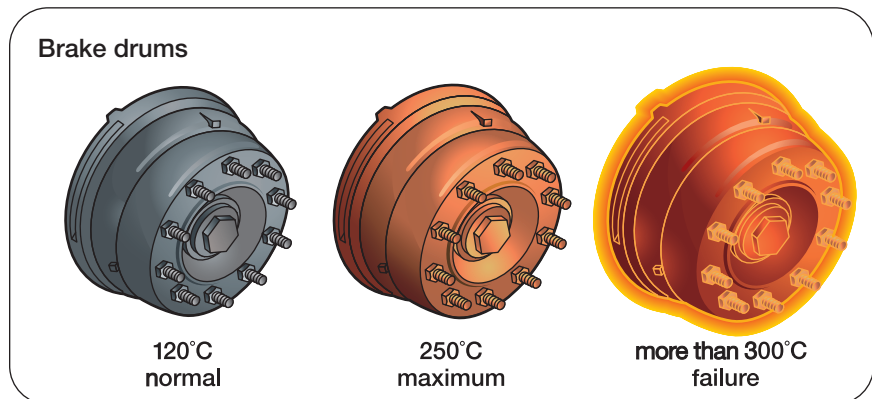

definition

Retarders provide an auxiliary slowing effect and assist the main brake system to slow the vehicle.

Retarders

Retarders are designed to provide auxiliary slowing of the vehicle, such as for controlling the speed on long downgrades without the use of the main braking system. Engine retarders (also known as engine brakes) help to save the main braking system for emergency stopping.

Here are the four main types of retarders:

- engine retarders
- exhaust retarders
- hydraulic driveline retarders
- electric driveline retarders.

Many retarders can absorb as much or more horsepower as the engine can develop.



An engine brake control switch.

driving tip

Make sure you're familiar with the manufacturer's operating procedures before operating any retarding device.

Using retarders

An engine retarder is more efficient at a higher engine r.p.m. and a lower vehicle speed, so it's important to select the right gear. Select your gear before you start down a hill. You're more likely to miss a shift if you wait until you're on the downgrade.

Be cautious if you're using retarders/engine brakes on slippery road surfaces. Some can actually cause the drive wheels to lock up, stalling the engine, and can result in loss of control or even cause a tractor/trailer to jackknife.

All modern trucks are manufactured to meet safety standards, including noise levels. A well-engineered truck with an engine retarder and a properly maintained muffler system shouldn't be noisy.

Many municipalities post signs restricting drivers from using engine retarders/engine brakes. Obey these signs.

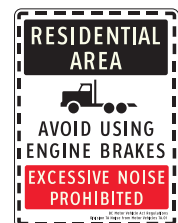

definition

The term **r.p.m.** stands for revolutions per minute. This refers to the number of complete turns the crankshaft makes in one minute.

Most trucks have a tachometer in the instrument panel to indicate the engine's r.p.m.

fast fact

You can be fined as much as \$2,000 if you are operating a vehicle with brakes that are not adjusted correctly or not performing adequately.

driving tip

Don't wait until you spin out on a hill to put on the tire chains.

It's extremely difficult to mount chains when you are on a hill. Instead, use a designated chain-up area.

fast fact

Frequent use of the service brakes will cause them to heat up and reduce their stopping ability.

The result can be a dangerous condition called brake fade.

Braking

Bringing your vehicle to a stop on a level roadway usually means squeezing gradually and firmly on the brake pedal with your foot. But sometimes you may have to react more quickly.

Just before your vehicle comes to a full stop, reduce the pressure you're placing on the brake pedal. This will prevent your vehicle from jerking back. Practise stopping until you become familiar with how much pressure you need to ease off the brake to smoothly stop where you want.

Watch the driving technique of the driver ahead. If the driver in front of you is a tailgater, expect frequent panic stops. Professional drivers maintain a safe following distance and plan for gradual stops. By making your stops slowly you give the driver behind you plenty of notice that you're reducing your speed.

To stop safely, ensure that your brakes are correctly adjusted, your load is balanced and your tires are in good condition. Also, be certain that your tires are properly inflated.

To ensure a smooth, controlled stop every time:

- travel at a speed that allows you to see a safe distance ahead
- maintain a safe following time or distance
- use good braking skills.

Icy roads

To stop on icy roads, use extremely light pressure on the brake to control your vehicle's speed. This will help prevent the wheels from locking up. A slowly revolving wheel on an icy surface will be more effective than a locked wheel skidding on an icy surface. Vehicles equipped with anti-lock braking systems (ABS) will require a different technique for braking on an icy road surface, as shown later in this chapter.

You need snow tires and/or chains on icy roads. Many highways have designated chain-up areas to allow you to mount chains before getting onto steep hills. Make sure you're familiar with how to mount chains on tires — practise mounting them before you find yourself in conditions where you need to put them on your vehicle.

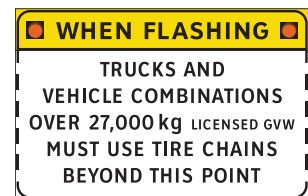

Make sure tire chains are properly sized for your tires and tightly mounted (don't deflate tires to install tire chains). Stop and check tire chain tightness at the first safe opportunity. Reduce speed when driving with tire chains.

In extremely bad conditions, parking your vehicle may be safer than driving. Check weather and road conditions before you encounter icy roads.

Downgrades

There's a limit to the amount of heat that brakes can absorb and dissipate. The highest brake temperatures occur when braking from highway speeds while on long downgrades, or from repeated use of the brakes without enough cooling time between applications. Almost all brake failures and downhill runaway crashes are caused by overdriving the ability of the brakes to deal with heat. In other words, poor speed control.



Some steep hill warning signs show the steepness of the grade. The higher the percentage, the steeper the hill. This hill has an 18 per cent gradient, which is very steep.

Whether in town or on a highway, you'll usually need to descend a hill more slowly than other traffic in order to avoid overdriving your brakes. You should be in a lower gear to go down the hill than used to climb it. **Never shift to a higher gear** on a downgrade unless the speed on the grade can be controlled with a retarding device or engine compression.

On highways

Truck advisory speed limits are often posted. Follow these speed limits. Use your four-way flashers to alert other drivers that you're driving slowly down the hill. Stay in the far right lane where possible. Control your speed all the way down every hill so you can respond to any emergency.

Select a safe speed that's not too fast for the weight of your vehicle, length, and steepness of the grade, weather, and road conditions. Use an appropriate low gear to hold that speed, and use the vehicle's retarding device.

If you've selected an appropriate safe speed, are in the right low gear and are using your vehicle's retarding device, you should be able to go down the hill without using the service brakes.

fast fact

Engine retarders are most effective at a higher r.p.m. and with the transmission in a low gear. Save your brakes so you'll be able to stop if road and traffic conditions require their use.

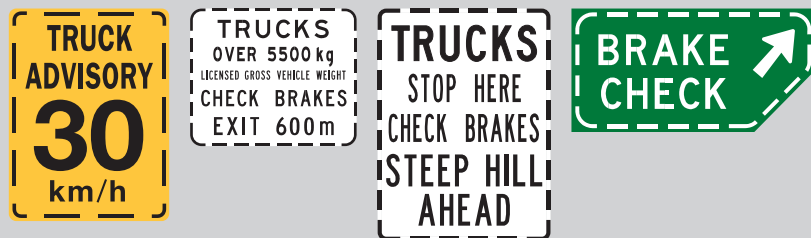

These signs, showing special instructions for commercial vehicles, may be placed before a downhill grade. The one in the top left corner shows the speed suggested for descending the grade. The other signs direct you to check your brakes.

fast fact

Always obey the regulatory stop and check brakes signs.

If this doesn't control your speed, and speed is increasing above your chosen speed:

- apply the brakes hard enough to reduce speed by 10 to 15 km/h — the brakes are cold at this point
- downshift to a lower main gear (don't use the splitter valve for shifting on a downhill).

Continue down the grade, using engine compression, transmission gearing and your vehicle's retarding device to control your speed. If the speed increases again, repeat this process. Be careful using this procedure on icy roads.

Keep your vehicle in gear all the way down the hill.

In town

- select a safe speed that's not too fast for the weight of your vehicle, length, and steepness of the grade, weather and road conditions
- select an appropriate low gear to hold that speed
- use the vehicle's retarding device unless signs prohibit their use.

You must control the speed of your vehicle so it can be stopped at any time for any emergency while descending a hill.

Water on roadways

Water can reduce braking efficiency. Avoid driving through large amounts of water whenever possible. If you have to drive through water on the roadway, cover the brake pedal with your foot as you approach the water. Place a slight drag (that is, apply a slight constant pressure) on the brakes while you drive through the water. The slight drag placed on the brakes will reduce the amount of water entering the brake drums and shoes. Always reduce your vehicle's speed before driving through large pools of water on the roadway.

During extremely wet conditions, or after driving through water, test your brakes by applying a slight pressure with your foot on the brake pedal. Keep this pressure on for a short distance to dry out the brakes.

These two road signs alert you to runaway lanes.



This sign is posted in advance of a runaway lane.



This sign is found at the entrance to a runaway lane.

Runaway lanes

Runaway lanes are located beside the road on some downhill grades.

These lanes are there to help slow and stop vehicles if their brakes fail as they are going downhill. Runaway lanes should be used only to control your speed or stop.

These lanes are there for safety. Don't use them for any other purpose.

Combination unit braking

When you step on the brake pedal of a vehicle with air brakes, all of the brakes apply at the same time and at the same pressure. Trailers equipped with electric or vacuum brakes work in a similar way.

Applying brake pressure too forcefully or only applying the trailer brakes on slippery roads may cause the wheels to lock up, which can result in a skid or jackknife. Use extra caution when applying brakes in a curve.

Remember that the brakes, tires and suspension of a combination vehicle work best when the vehicle is legally loaded and the load is properly distributed among axles. When the cargo area is empty and there's no ABS, the vehicle's wheels may bounce and lock up. This can make braking more difficult and increase your stopping distance.

You need to take extra care to safely tow two trailers. It can be difficult in an emergency to stop a multiple trailer combination in a straight line. In bad weather, slippery conditions and mountain driving, the risk of skidding and loss of traction increases. Look far ahead, leave plenty of following distance, and slow down to help avoid having to make emergency stops.

Anti-lock braking systems

Anti-lock braking systems (ABS) are mandatory in Canada on all trucks and buses over 4,560 kg manufactured since April 1, 2000 and on all commercial trailers equipped with air brakes.

ABS is an addition to a normal air brake system. It helps prevent wheel lockup or skids caused by overbraking on slippery road surfaces.

Contrary to what many people believe, ABS doesn't allow you to drive faster or stop sooner. In fact, on some surfaces such as gravel, the braking distance needed with ABS may be longer.

ABS can help prevent wheel lock-up on surfaces where conventional brakes usually lock up, including slippery surfaces. This means you can brake hard without skidding and losing steering control. ABS may also help you prevent your vehicle from jackknifing.

ABS is only as good as the driver. Learn the correct technique and practise it so that you're ready in an emergency. Read the manual from your vehicle manufacturer to learn how to use your ABS properly.

definition

A **full jackknife** occurs when a tractor and the trailer form an angle of 90 degrees or less, relative to one another.

Warning: this can happen even at very low speeds. Jackknifing is often caused by poor braking techniques, including improper use of retarders.

A fully jackknifed tractor/trailer combination.

driving tip

It's a good idea to practise using ABS so that you're familiar with how it works and feels.

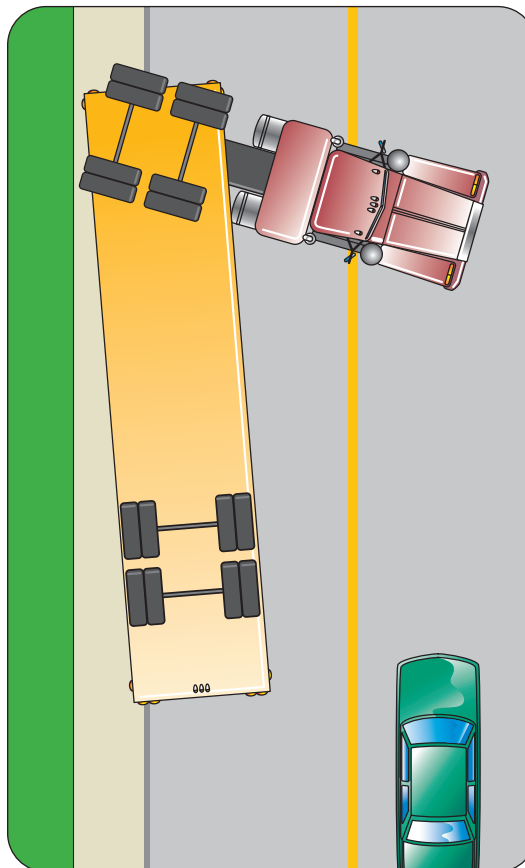

A few tips for **emergency** stopping with ABS:

- Apply firm, hard continuous pressure to the brake pedal until the vehicle stops.
- Don't pump the brakes — this turns the system on and off.
- Don't be alarmed by brake noise, pedal movement or shudder. This is normal. Keep applying firm pressure.
- Be extremely cautious when steering around obstacles. Remember that steering and handling characteristics will be affected by the size and load of the vehicle you're driving, and by the trailer you may be towing.
- When you operate combination vehicles, make sure you know which of the units have ABS. If the tractor and trailers do not **all** have ABS, apply the brakes as if you were operating a combination without ABS.

Automatic traction control

Automatic Traction Control (ATC) is an optional addition to an ABS system. It uses the pulsating signal from the speed sensors to detect loss of drive wheel traction on slippery road surfaces.

Using the same wheel sensors used by ABS, ATC can sense if a wheel has lost traction and is spinning instead of helping to accelerate the vehicle. If a drive wheel begins to spin, the traction control system will apply that brake, transferring power to the opposite side. In extremely slippery conditions, the traction control system will reduce engine power, allowing the wheels to regain traction.

Most vehicles equipped with ATC will have an information decal on the dashboard and a dash-mounted lamp that will light if wheel spin occurs.

Review questions

1. What's the final factor that will determine if the vehicle will move?
2. How is brake heat dissipated?
3. If the weight of the vehicle is doubled, how many times must the stopping power be increased?
4. What causes brake fade?
5. What can cause jackknifing?
6. What's the difference between ABS and ATC?
7. What's one of the hazards of stopping a tractor/trailer combination?
8. When should a retarding device be used?
9. What's brake lag time?

This chapter includes information on basic skills, driving in traffic and vehicle and personal safety.

What you'll learn

After studying this chapter you'll be able to:

- describe various techniques for driving safely in traffic
- define the term danger zone and describe how to reduce the size of your danger zone
- describe the factors that affect your vehicle's turning characteristics and techniques to help you turn safely
- describe how to back up safely
- describe when and how to shift gears
- describe how to handle each of the following special situations: passing and being passed, parking, intersections, crossing railway lines, various weather conditions and night driving
- identify potential vehicle and personal safety issues and describe how to reduce risks for yourself and other road users.

Sharing the road

When you're sharing the road with other vehicles, it's important that you know how to follow safely, deal with tailgaters and identify your danger zone. These sections provide information that can help you drive safely when there are pedestrians, cyclists and other vehicles on the road. This chapter will also further develop the road safety topics introduced in chapter 2.

Following distance

You can establish a safe following distance using different rules. The rule you should use depends on the type of vehicle you're driving.

In all cases, rules for determining how closely you can safely follow another vehicle apply to ideal driving conditions. If conditions are less than ideal, **increase your following distance**. Driving conditions are affected by:

- road conditions
- vehicle conditions
- your physical and mental condition
- traffic conditions
- lighting conditions
- weather conditions.

fast fact

More than 27 per cent of all greenhouse gas emissions in Canada are produced by the road transportation sector. Heavy-duty vehicles account for 19 per cent of this total.

Good safe driving habits can reduce fuel consumption by as much as 30 per cent, save thousands of dollars a year in fuel and maintenance costs, and reduce emissions.

For more smart ways to be fuel-efficient, visit Natural Resources Canada's Office of Energy Efficiency website at www.oeenrncan.gc.ca or call 1-800-387-2000.

Taxi, limousine, ride-hailing vehicle, ambulance or van

Drivers of passenger cars and light trucks should use the two-second rule for keeping a safe following distance:

1. Watch the vehicle ahead pass some checkpoint on the roadway, such as an overpass or sign post.
2. Start to count: "One thousand and one, one thousand and two." That's two seconds.

If the checkpoint is reached before the count is finished, your following distance isn't enough — drop back, pick a new checkpoint and count again.

If you're following a motorcycle, you'll need to leave even more space because motorcycles can stop quickly.

Lengthen your following distance on the highway and when road or weather conditions are poor.

Remember to leave at least two seconds between your vehicle and the vehicle in front when driving a taxi, limousine, ambulance or van. A mailbox is the checkpoint in this illustration.

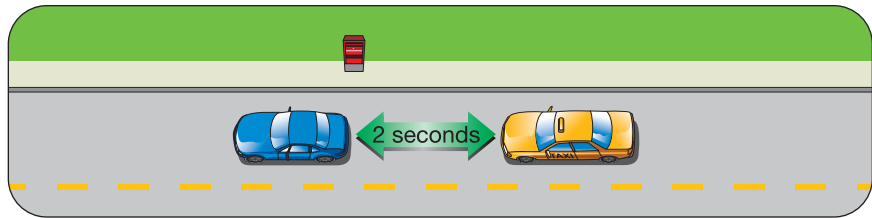

Bus, truck or other heavy vehicle

Since you need more time and distance to stop if you're driving one of these vehicles, keep at least a five-second following distance.

Keep at least a five-second following distance when driving a bus, truck or heavy vehicle.

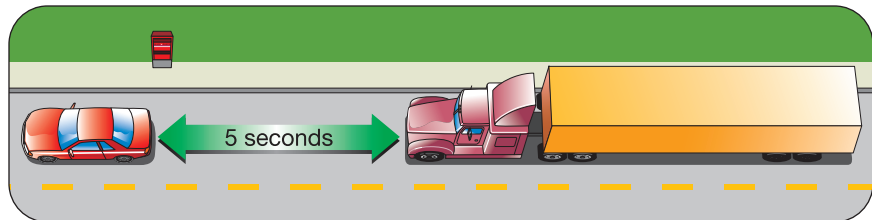

When conditions are less than ideal, increase the number of seconds and adjust your following distance.

Traffic flow

Your travelling speed depends on driving conditions, including traffic flow. You need to match your travelling speed with the traffic flow while staying within the speed limit.

definition

Traffic flow refers to the movement of a group of vehicles travelling on one road. The actions of any vehicle within this group may affect several or all of the other vehicles.

Driving faster than the flow

If you drive faster than the traffic flow, you increase your chance of crashing into vehicles in front of you.

- You won't be able to maintain a safe following distance, which means you will be unable to stop quickly and safely.

- You increase your chance of making a wrong decision. Driving faster than the traffic around you requires more lane changes. Each lane change represents a problem that requires quick decision-making. The more decisions you make, the greater the chance you'll make a wrong one.
- You'll tire more quickly. Driving faster than the traffic flow creates tension and causes mental and physical fatigue.

Maintaining a steady speed, within legal limits, at a safe following distance will help give you the time needed to react in an emergency situation. Driving at a steady speed also saves money and helps the environment by reducing the amount of fuel your vehicle burns.

Driving slower than the flow

If you drive slower than the traffic flow, you increase your chance of a collision with vehicles travelling behind or beside you. Other drivers will become impatient and follow too closely or try to overtake your vehicle. After passing, they may cut in leaving you with little or no room for a quick stop.

Large vehicles tend to accelerate and travel more slowly than small vehicles. When you're unable to keep up with the traffic flow, you must travel in the right lane.

Tailgaters

Drivers of large vehicles must rely on outside mirrors for rear vision. You may not be able to see tailgaters who sit in the blind spot directly behind you.

You also may not always be able to prevent a rear-end collision caused by these drivers, but if stops are gradual, the impact may be much less.

Tailgaters are easiest to deal with when they're in front of you. It's a good safety practice to allow tailgaters to pass. Watch for these drivers by checking your rear-view mirror frequently.

When you drive a large commercial vehicle on a highway, leave at least 60 m (200 ft) between your vehicle and other large commercial vehicles.

Always use the right lane when you're travelling more slowly than other traffic and are going up or down a hill where a passing lane is provided. In some cases, signs require slower drivers to keep to the right lanes.

Vehicles may build behind you when you're driving on a one-lane road and travelling more slowly than other traffic, such as when going up a hill. Allow them to pass as soon as it's safe.

It's a good safety practice to use your four-way flashers when you're driving slowly up or down a hill (some companies require this).

Vehicles, machinery or combinations of vehicles that travel at less than 40 km/h should display a red triangle **slow moving vehicle** sign. Don't put this sign on any stationary object or on any vehicle that's travelling faster than 40 km/h.





Construction zones

Look for construction zones ahead and look out for traffic-control persons, construction workers and equipment. Remember, road construction doesn't just occur in the daytime.

In some construction zones, you may need to wait for a pilot car to escort you through the work zone. Leave plenty of following distance between your vehicle and the vehicle immediately ahead. Avoid changing lanes in a construction zone. Also leave space between you, the construction crews and their equipment.

Check radio, television and websites for the latest in traffic reports and updates to find out what's happening along your area roads and intended route. Consider taking an alternate route.

fast fact

Professional drivers:

- set their pace according to existing conditions and traffic flow
- maintain a safe stopping distance ahead and behind
- maintain driving space all around their vehicle
- have time to read the traffic pattern
- continuously plan an escape route in case the danger zone becomes occupied.

Danger zones

The section of road a vehicle travels through before it can stop is called the vehicle's danger zone because it's physically impossible for you to stop in time to avoid a collision with any object or person.

As your speed increases, the length of your danger zone increases. Less than ideal road conditions, such as rain, snow, ice or gravel, increase the length of your danger zone. Driving fast in these road conditions increases your danger zone even more.

Reduce your danger zone by slowing down. Remember, it's easier to keep out of trouble than get out of trouble.

Your danger zone is reduced when your vehicle's speed is reduced. You also reduce your danger zone when you cover the brake pedal with your foot any time you see a potential hazard developing (for example, whenever you approach an intersection).

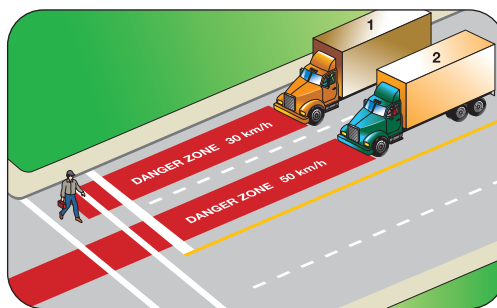

Truck 1 is approximately 2½ vehicle lengths from the crosswalk when the driver sees the pedestrian. Under ideal conditions, the driver may be able to stop just in time.

The driver of truck 2 can't stop in time, even under ideal conditions.

See **Speed and weight facts** in **chapter 2**.

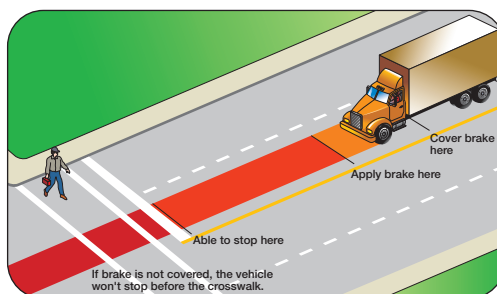

As soon as you see a potential hazard in your danger zone, remove your foot from the accelerator and put it lightly on the brake pedal. This will help you apply the brakes sooner if you need to make an emergency stop.

Removing your foot from the accelerator and putting it lightly on the brake pedal when you first see a potential hazard in your danger zone reduces your reaction time. Your speed is slowing so you have a better chance of stopping before the crosswalk rather than in the intersection.

Manoeuvring

There are many different types of commercial vehicles and each type has its own driving characteristics. In most cases, commercial drivers operate vehicles that are larger, heavier and longer than others on the road. The extra size, weight and length affect the way these vehicles move, especially around turns and while backing up.

Steering into turns

Steering and handling characteristics are different for conventional, cab-over and forward-control vehicles.

In a conventional design, the driver's seat and steering wheel are positioned behind the steering axle. In a cab-over design, the driver's seat is above the steering axle. In a forward-control design, the driver's seat is in front of the steering axle. The position of the driver's seat is different in each of these configurations, which affects your viewpoint when turning. You'll start your turn at a slightly different point on the turning path depending on the type of vehicle you're driving (conventional, cab-over or forward-control).

These steering differences are apparent even in small vehicles. In large and long vehicles the differences are magnified. The length of your vehicle and the number of articulation points it has will also affect where you start your turn. You'll notice these differences and must account for them when you switch from one type of vehicle to another.

Wheel positions during turns

Steering a large vehicle has the same basic principles as a passenger vehicle. But steering a large or combination vehicle can be much more complicated.

As the operator of a large vehicle, you'll need to consider these two factors which determine the sharpness of your vehicle's turn:

Turning radius

How sharply you can turn the front wheels of your vehicle depends on the make and model of the vehicle you're driving. In all cases, the wheel on

the inside of the curve (closest to the direction you're turning) will turn more sharply than the wheel on the outside of the turn. The inside wheel will have a shorter turning radius than the outside wheel.

The wheel on the inside of the turn must pivot more sharply to travel on the shorter radius than the wheel on the outside of the turn.

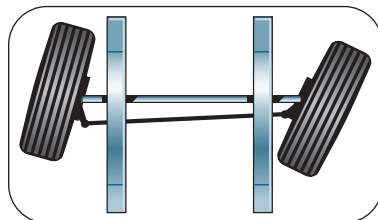

The solid lines in this illustration show the turning radius of the vehicle's steering tires.

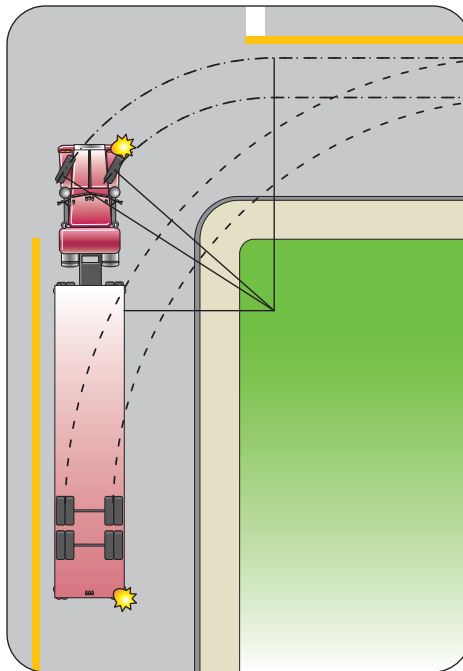

The radius is the distance from the centre of a circle to the edge of the circle. When a vehicle turns a corner, it's travelling on a curve. If that vehicle were to continue on the same path, it would eventually drive in a complete circle. The distance from the centre of that imaginary circle to the vehicle's wheel is the turning radius.

A vehicle's rear tires have a different turning radius than its front tires. It is important to know how to judge the turning radius of your front tires to prevent your vehicle's rear tires from cutting the corner.

definition

Wheelbase is the distance between the front wheels and the rear wheels of a vehicle.

Off track

When a vehicle moves around a curve, the rear wheels follow a different path than the front wheels. The difference between the path of the front wheels and the path of the rear wheels is called off track. The greater the distance between the front wheels and the rear wheels of a vehicle, or a combination of vehicles, the greater the amount of off track.

Vehicles with longer wheelbases have more off tracking than those with short wheelbases. A combination vehicle will usually have more off tracking than a single-unit vehicle.

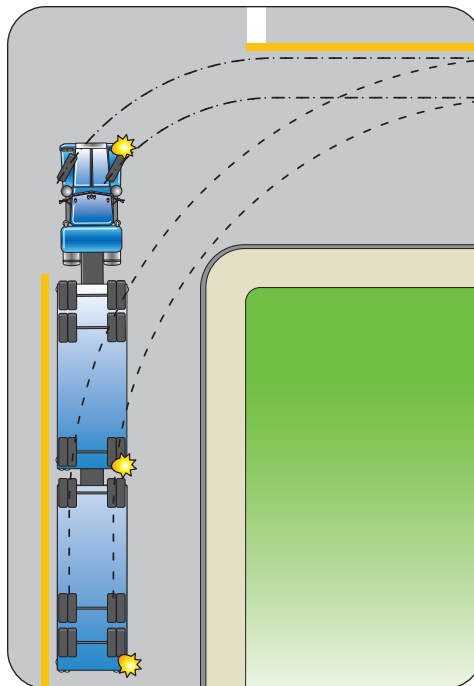

Each set of wheels behind the front wheels turn with some off tracking. A combination vehicle displays several sets of off tracking. The rear wheels of the tractor turn somewhat off track from the front wheels. The rear wheels of the trailer turn with even more off tracking.

A single-unit vehicle and a truck-tractor and semi-trailer demonstrate different turning characteristics.

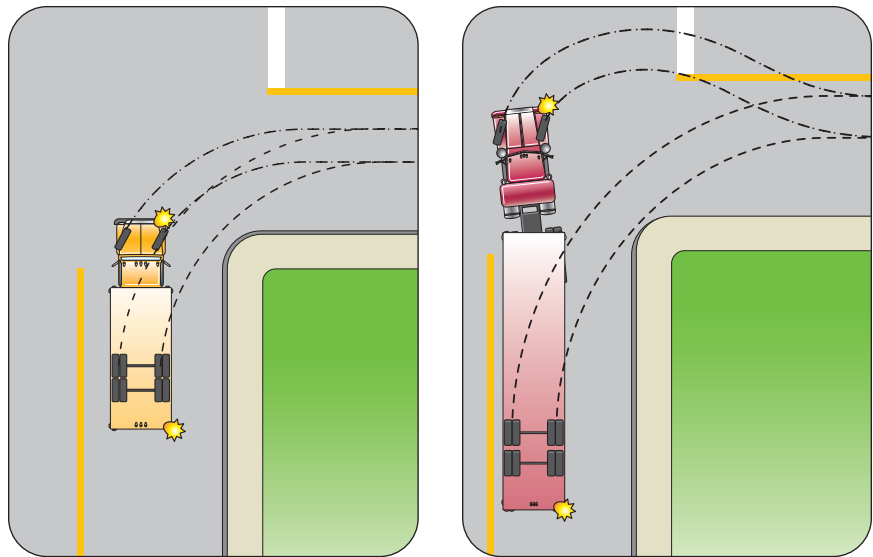

A single-unit vehicle has different turning characteristics than a truck-tractor and a semi-trailer. Each unit that has more than one set of wheels will have a turning radius and an off-track pattern within itself. The amount of off track depends on a number of factors including the wheel base of the units and the location of the pivot points between the truck and trailers (for example, draw bar connection point or location of the fifth wheel). The longer the wheel base, and the longer the draw bar length or the farther back the fifth wheel is mounted, the greater the amount of off track.

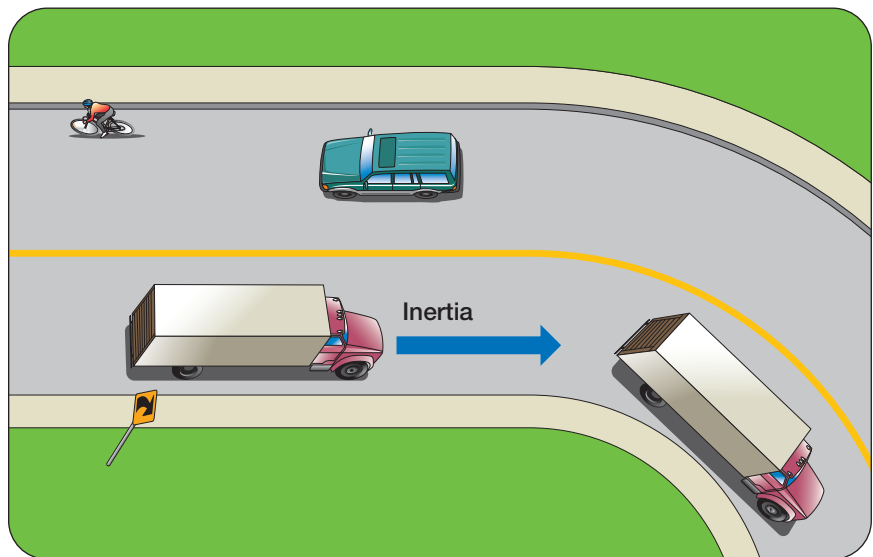

Inertia affects a moving vehicle in a curve.

Curves and turns

Several forces work against you while you move your vehicle around a curve or through a turn. You need to be aware of these and approach each curve at a speed that allows you to safely control your vehicle.

Inertia is the tendency for moving objects — in this case you and your vehicle — to continue to move forward in a straight line. When you brake, inertia tries to keep your vehicle moving. When you go around a curve, inertia tries to keep you going in a straight line.

The faster you're going and the heavier your vehicle, the more inertia pushes your vehicle away from the path of the curve. The faster you're travelling, the more difficult it'll be to keep your vehicle on the path of the curve.

Traction is the grip your tires have on the road. The amount of traction your tires have with the road's surface determines the amount of control you can maintain over your vehicle. If you enter a curve too quickly and try to slow down by applying your brakes, you may lose traction, causing your vehicle to skid, roll over or jackknife.

Reduce your speed before you enter a curve. Enter each curve at a speed that doesn't require you to brake and allows you to apply gradual power while you're in the curve. Make sure you obey any suggested speed signs in curves to avoid tipping over.

definition

Traction is the grip created between a vehicle's tires and the road.

fast fact

Tires that are in poor condition provide poor traction.

Curves

When you curve to the right, keep the front wheels close to the centre line so that your rear wheels don't drop off the pavement or go onto the pavement shoulder.



Curve ahead — trucks and buses slow to suggested speed to avoid tipping over.

Position of a tractor and semi-trailer's wheels when turning to the right.

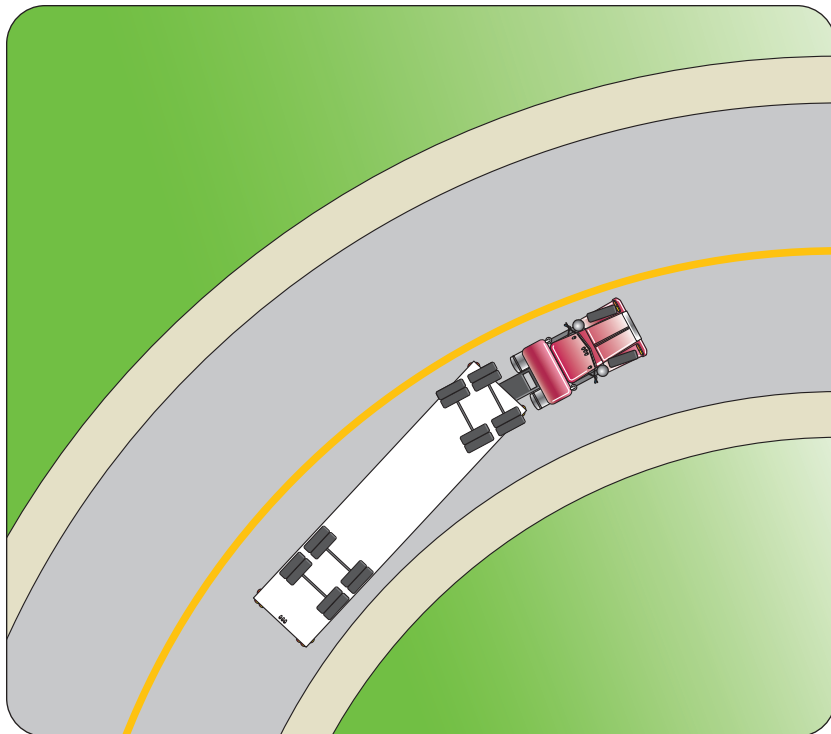

When curving to the left, keep the front wheels close to the right edge of the lane to keep your driver's side rear wheels out of the next lane of traffic.



Curve ahead — slow down.

Position of a tractor and semi-trailer's wheels when turning to the left.

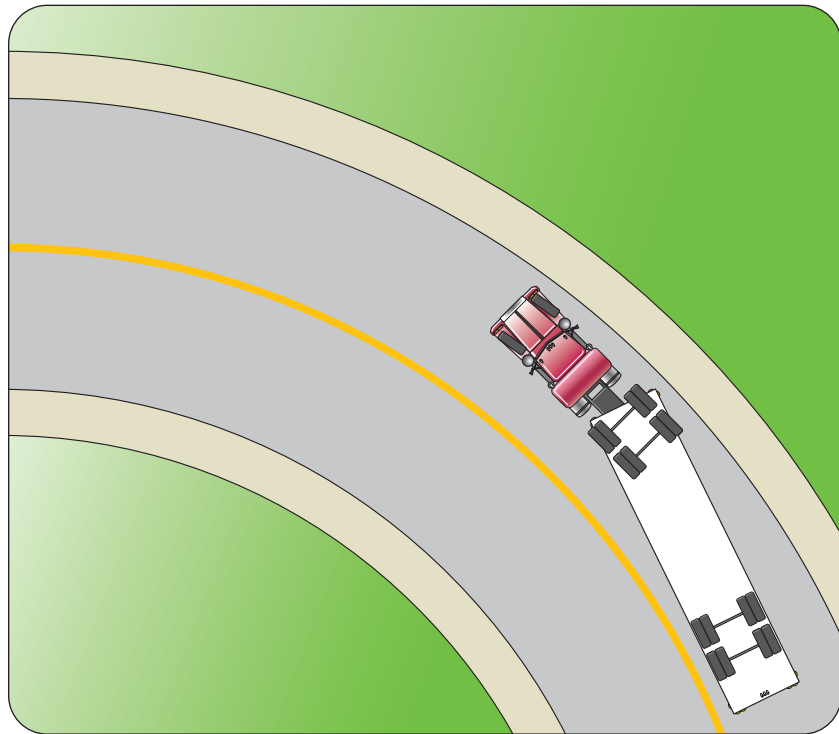

Always watch for signs warning of curves and turns, and adjust your speed and approach.

Negotiating narrow bridges

Entering a narrow bridge with a curved approach requires the driver of a large unit to use caution and skill. You must be familiar with the amount of off track your vehicle displays. Use this information to adjust your speed and approach to the curve so that you can enter the bridge safely.

Turning right

When turning right, you need to think about the length of your vehicle including the trailer(s), the off track of the rear wheels, the layout of the streets and the particular intersection where you'll be turning, and traffic at or near the intersection.

These factors will influence your plan for positioning your vehicle to start the turn, and how far from the curb you want to be upon completion of the turn.

If the turning arc of your front wheels is too small, off tracking may cause the back wheels of your trailer to scrape the curb or even leave the road. You'll almost certainly crowd anyone, such as a cyclist, who's travelling on your right side. Running your rear wheels over curbs and sidewalks can damage your tires and seriously injure pedestrians and cyclists. You may hit a power pole, sign post or lamp standard if your vehicle doesn't have enough room to turn. This type of collision can damage your vehicle, as well as the object it hits.

Combination vehicles take more room to turn than single vehicles. Allow yourself enough room to make the turn. Don't accidentally drive up onto the curb and hit an object such as a lamppost.

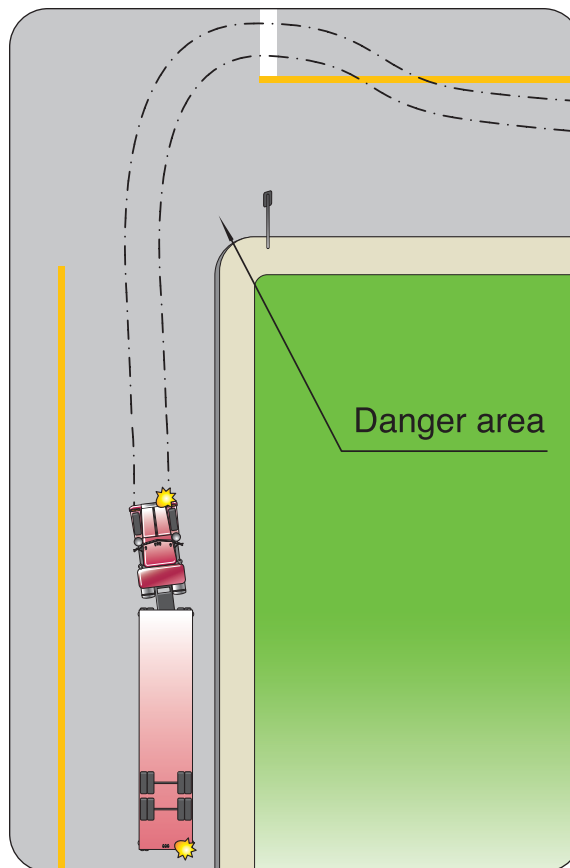

Check whether smaller vehicles, motorcycles or cyclists are on the right side of your vehicle whenever you make a right turn. Also check for pedestrians on or near the curb. The most dangerous point in a turn is when the tractor has made the turn but the trailer hasn't. At this point the right rear-view mirror is turned so that it's almost useless.

If the streets are narrow and you can't make the right turn without swinging into another lane, you may need to turn wide as you complete the turn. If you must cross into the oncoming lane to make the turn, watch out for vehicles coming toward you. Give them room to pass by or to stop. Don't back up for them, because you might hit someone behind you.

You should keep the rear of your vehicle close to the curb. This'll prevent other drivers from passing you on the right.

Use extreme caution and ensure the movement can be made safely. It's your responsibility to be certain you can move safely without holding up traffic.

Sharp right turns

To make a sharp right turn (particularly with a forward-control vehicle such as a bus):

1. Position the vehicle one to two metres from the curb on the approach to the intersection.

The driver moves the bus into the intersection until the curb on the side street becomes visible. The driver then begins the turn.

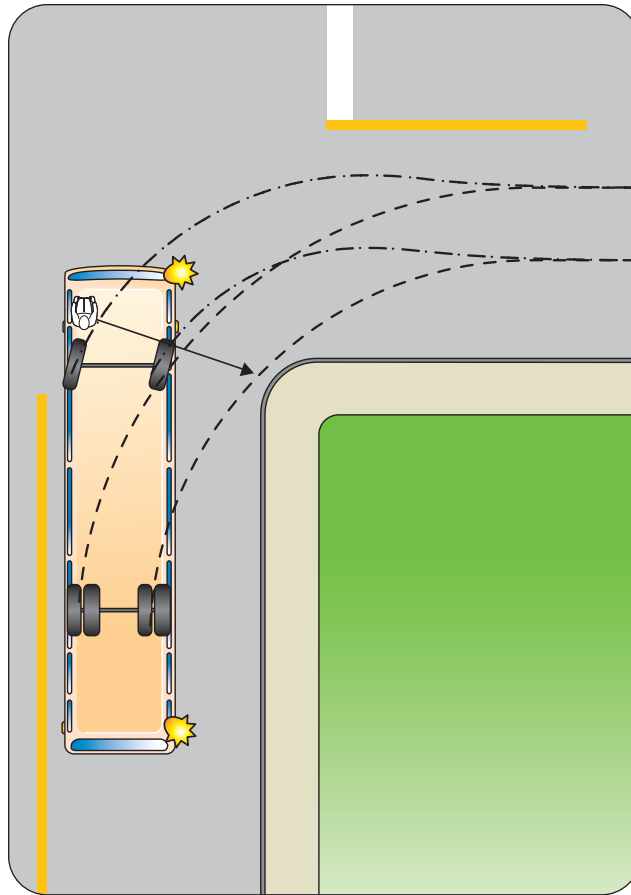

2. Drive straight until the curb line of the side street can be seen through the front entrance door (if you're operating a bus).
3. Enter the turn at a low speed. This will allow you to turn the steering wheel more slowly, which will let you make a smoother turn using less energy.

The hand-over-hand steering method is recommended when you need to do a lot of turning. Pull on the right half of the wheel for right turns and the left half of the wheel to make left turns. Don't grasp the inside of the steering wheel. If you do and the wheel slips or jerks, you may injure yourself.

These hand positions are recommended for right- and left-hand turns. Always use both hands to steer your vehicle.

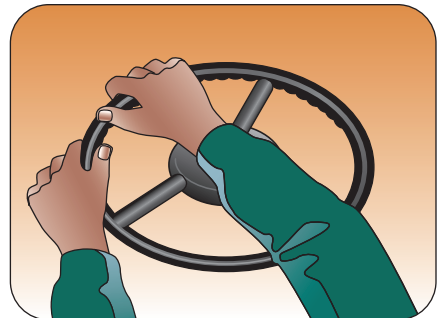
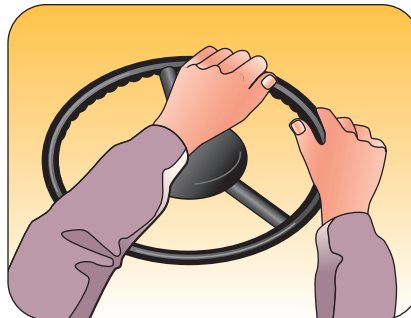

Turning left

Just as with right turns, ensure your vehicle's turning arc is large enough to keep your vehicle from cutting the corner. If you turn too soon, the left side of your vehicle may hit another vehicle in the intersection or run over a median because of off tracking.

If you're turning into a multi-lane street, the size of your commercial vehicle may make it difficult to turn into the leftmost lane. Instead, you may choose to turn into a lane to the right. Be sure it's safe and available to you.

If there are two turning lanes, you should turn from the right-hand turn lane as this lane will better accommodate your vehicle's off tracking.

As with right turns, check for pedestrians and cyclists when turning left.

Traffic circles and roundabouts

These are found in some areas to help ensure safe passage of traffic through an intersection without having to stop the flow of traffic. Roundabouts, while generally larger than traffic circles, work the same way:

- slow down as you approach the circle
- yield to any traffic in the circle
- if another vehicle arrives at the traffic circle at the same time as you do, yield to a vehicle on your right
- go around the traffic circle to the right (counter-clockwise).



Traffic circles

Traffic circles are designed for use in residential streets where trucks and buses don't usually travel.

If you're driving a large truck or bus through a traffic circle, encroaching onto the median is okay to get through.

Turn right to enter a traffic circle and turn right again to leave it. Yield to vehicles that are already in the traffic circle. If another vehicle arrives at the traffic circle at the same time as you do, yield to the vehicle on your right.

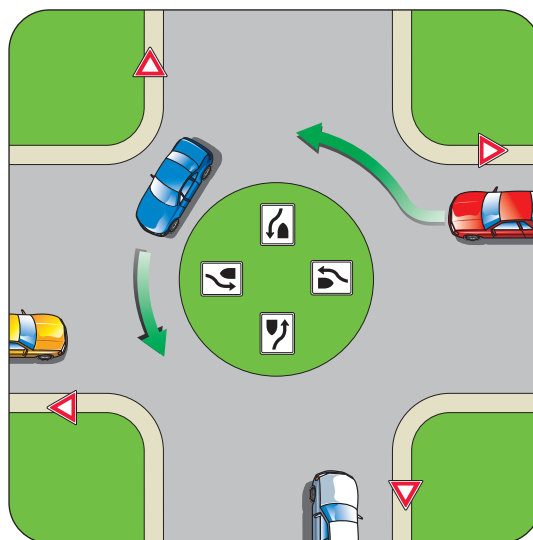

driving tip

Traffic circles and roundabouts often have a truck apron around the edge of the island in the middle. Large vehicles may need to drive over the apron in order to drive through the traffic circle or roundabout.

Slow down when approaching a roundabout and yield to traffic already in it. Take care when driving a large commercial vehicle, since you may need to take up more than one lane to get through the roundabout. When exiting, signal “right” in advance of your exit location.



This sign warns to keep away from large vehicles such as trucks and buses in roundabouts.

Roundabouts

Some roundabouts have more than one lane. Lane use signs and markings may be displayed at the approaches to indicate where you can go in each lane when you’re in the roundabout.

Make sure you know where you want to go — and are in the proper lane to get there — before you enter.



Take care when driving through a roundabout in a large commercial vehicle. Due to your vehicle’s off track, you may need to take up more than one lane. Make sure there are no vehicles in the lane beside you.

In the example above, the red car has entered the roundabout from the south in the right lane after first yielding to vehicles in the roundabout. The driver may either turn right at the east exit or continue straight and take the north exit.

The blue car entered from the south in the left lane, and has merged into the left lane in the roundabout. Because the blue car entered from the left lane, the driver can’t immediately turn right at the first exit (east), but can take either the north or west exit.

The tractor-trailer combination entered the roundabout from the east in the left lane and the driver is going to take the south exit. The trailer is partially in the right lane due to the length of the combination.

The driver of the green car must yield to the tractor trailer already in the roundabout.

Backing up

Backing up must always be done with extreme caution. With a few exceptions, you’ll be responsible for any crash that happens when you’re backing up. This manoeuvre becomes dangerous any time you don’t make certain the way is clear. You may have to check several times to be sure the way remains clear during the entire manoeuvre.

Most crashes that involved a backing-up vehicle are caused by drivers who didn’t see something they should’ve.

Follow these tips to reduce your risk of causing a backing-up crash:

- Avoid backing up whenever possible.
- If you must back up, plan ahead to minimize the distance.
- Be certain that the area you are backing into is clear.
- Use a person to guide your vehicle whenever possible. If you can't use a guide, get out of your vehicle and walk completely around it before you start to back up. Repeat this every vehicle length.
- Sound your horn at least once every vehicle length to warn other road users that you're about to move.
- Back your vehicle out of traffic rather than into traffic.

Remember that it's easier to back out of traffic than into traffic. The driver in the vehicle at the top drove straight into the loading dock, and will now have the difficult task of backing into traffic to get back onto the road. The driver in the vehicle at the bottom backed out of traffic into the loading dock, and can now easily drive forward to get back onto the road.

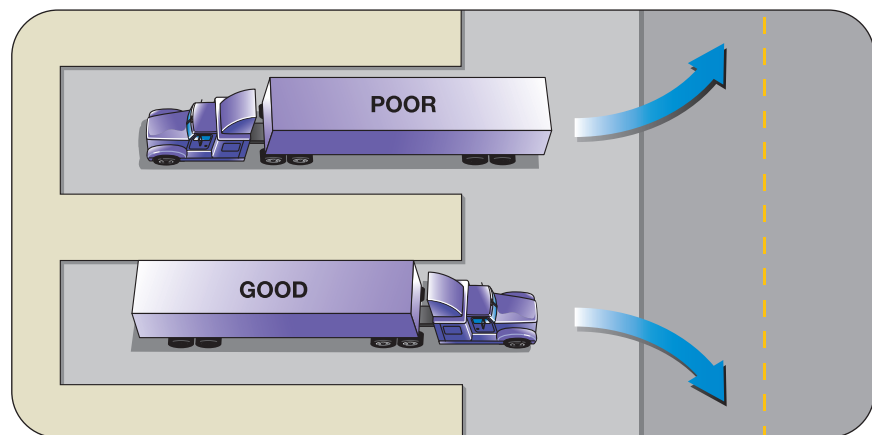

Don't back your vehicle into the blind side when it's possible to back into the view side. Make your approach in a way that allows you to see the area you are backing into before you put your vehicle into reverse.

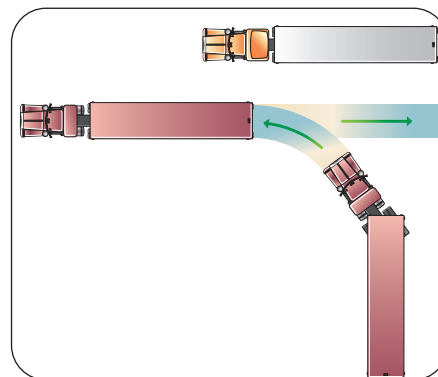

Make your approach so that you can see the area you're backing into.

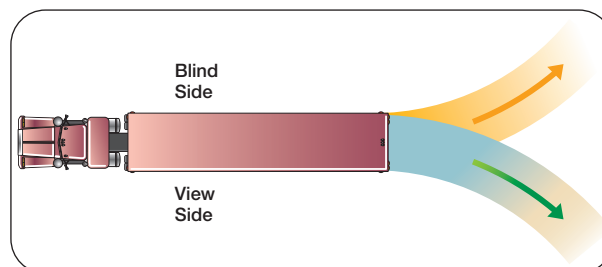

Whenever possible, back your vehicle into the view side, not the blind side.

Backing up with a guide

Whenever possible, use a guide — anyone who can watch carefully and warn you of hazards.

Position your guide where there's a clear, continuous view of the backing path your vehicle will follow and make sure you can see the guide throughout the manoeuvre.

In this illustration, the guide can't see the path directly behind the vehicle.

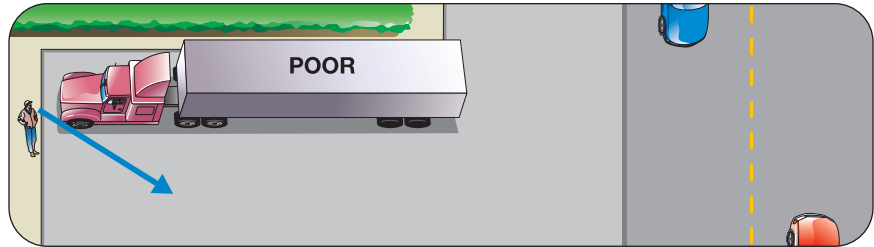

In this illustration, the guide can only see traffic coming from one direction.

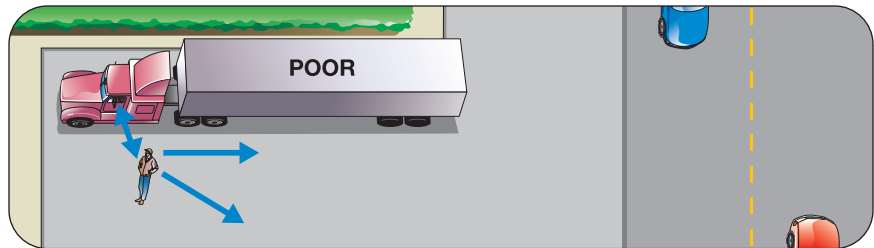

In this illustration, the driver can see the guide and the guide can see in all directions.

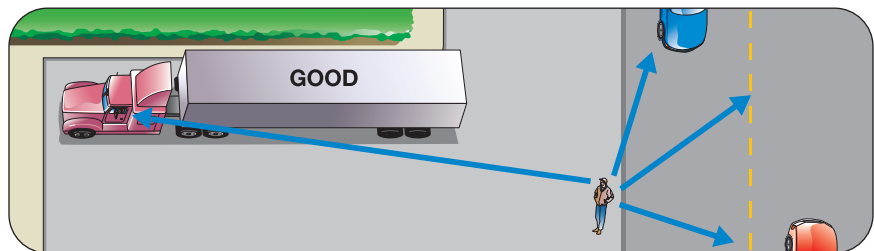

Backing up without a guide

Whenever you back up a vehicle without help from a guide:

1. Step out of the vehicle and check the backing-up area for hazards. Look for clearances and obstacles above, below, to the sides, to the rear and to the front of your vehicle.

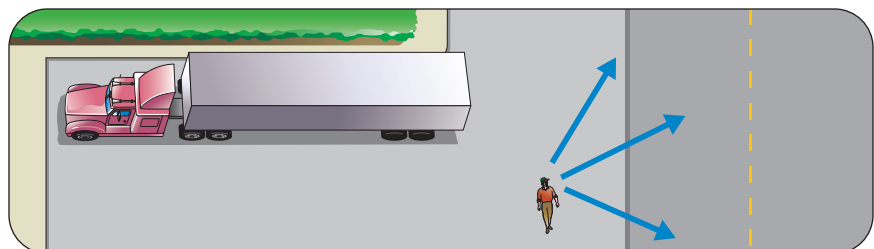

2. Enter the cab, sound your horn and watch both mirrors as you back up very slowly. A good practice is to sound the horn for each vehicle length you travel.

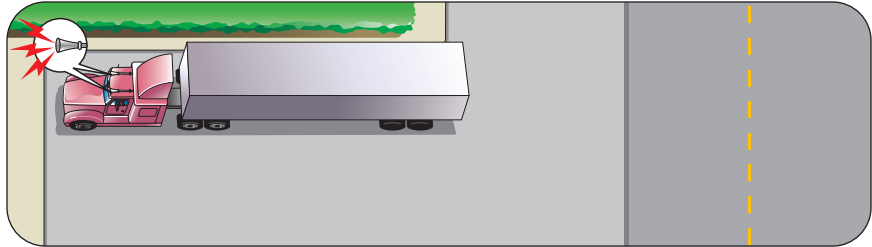

3. Stop, exit the cab and recheck behind, above, below, to the sides and ahead if you're backing up a long way. A series of short backing up manoeuvres is safer than one long one.

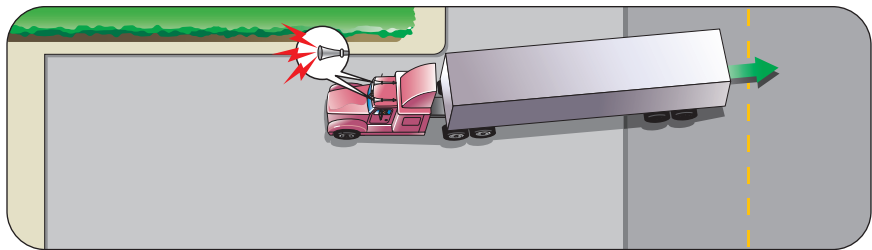

Seeing and being seen

While large vehicles usually offer a better view of the road ahead and to the sides than passenger cars, they also have dangerous blind spots.

Big windshields and a high seat position give you a good view down the road but there's an area immediately in front of your vehicle where you can't see anything. The longer the hood on your vehicle, the longer the blind spot.

The higher seat position can also hide a car or pedestrian alongside of your vehicle, particularly on the passenger side. Large side mirrors provide a clear view of the road behind you, except for the blind spot immediately behind every vehicle.

Check carefully for vehicles and bicycles that may be travelling in your blind spots. Pay particular attention in slow urban areas where cyclists often share the road.

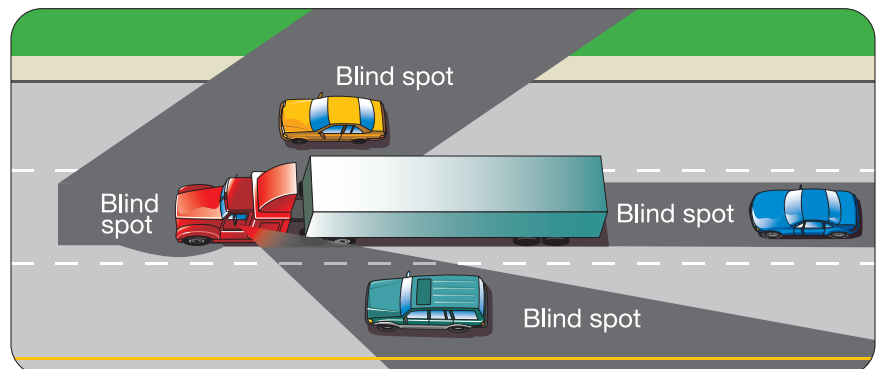

Watch for other drivers in any of your vehicle's blind spots.

fast fact

Convex or spot mirrors make things look smaller and farther away than they actually are.

driving tip

By looking ahead, keeping good space margins, and anticipating road hazards, you can avoid sudden stops and changes in speed. These smart driving habits also save fuel.

driving tip

Choose a lane that will allow you to go where you want to go and maintain a steady speed. The fewer lane changes you do, the better. Frequent lane changes increase the risk of a collision and can increase fuel consumption.

Always stay far enough behind the vehicle you're following to allow you to make your stops in a smooth, gradual way, even if the vehicle ahead makes a panic stop. Giving yourself enough room to make gradual stops reduces the likelihood of you hitting another vehicle and gives drivers behind lots of notice that you're reducing your speed. This reduces your chance of being hit by a tailgater.

Finally, never assume that the other driver has seen you. Many collisions are the result of drivers not seeing something the other driver expected them to see.

Using your mirrors

To drive defensively, it's important to know where your vehicle is in relation to other vehicles on the road. Scan the traffic ahead, behind and to your sides constantly. Look ahead for clues that will tell you whether other vehicles are about to change speed or stop. Frequent checks in your rear- and side-view mirrors will alert you to drivers who are passing or getting ready to pass you. These checks also help you know whether there are vehicles behind you. Give all drivers plenty of warning whenever you're about to stop, change directions or change lanes.

Looking ahead

You should develop the habit of watching the traffic well ahead of your vehicle. Look for traffic lights, turn signals, pedestrians and vehicles pulling into your lane or making other lane changes. Approach every intersection considering whether the lights are likely to change. A light that's been the same colour for some time is "stale." That means it could change before you reach the intersection. Be prepared to stop. Traffic lights are synchronized on some streets, so by driving at the posted speed you'll make every green light. Adjust your driving speed to take advantage of this.

Which lane should you use?

Choose the lane that gives you the best vision, allows you to go where you want to go, and that best allows you to blend in with other traffic. A right-hand lane is best on a multi-lane divided highway. This is especially important if you're driving more slowly than other vehicles or if signs direct you to keep out of the left lane.

On freeways, drive in the far right or centre lane, leaving the left lane for higher-speed traffic and passing vehicles.

Lane use

Look ahead for lane-use changes so you're prepared if the lane ends or becomes a turning lane. Be sure that you're in the lane that allows you to go where you want.

fast fact

On a divided highway with two or more lanes, the nearest edge could be the left shoulder.

You must yield the right-of-way to emergency vehicles such as police cars and ambulances. Whenever you see flashing lights and/or hear sirens, be sure to pull off to the side of the road and stop. If you're travelling in the left, or fast lane on a divided highway that has a median in the middle, pull off to the left side of the road.

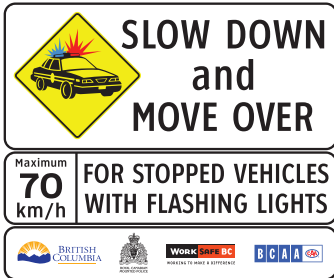

fast fact

Failure to change lanes and/or slow down when passing a stopped vehicle displaying flashing lights may result in a traffic violation and penalty points.

Emergency vehicles

Police cars, ambulances and fire engines are equipped with flashing lights and/or sirens. Yield the right-of-way to vehicles that are using flashing red or blue lights and sirens (or other audible warning signals such as buzzers or horns). You must quickly:

- drive to a position parallel to and as close as possible to the nearest edge or curb of the roadway
- stop your vehicle clear of any intersection
- remain stopped until the emergency vehicle has passed.

Don't assume that there's only one emergency vehicle on the road. Listen and look for others. When you resume driving, stay well back from the emergency vehicle(s).

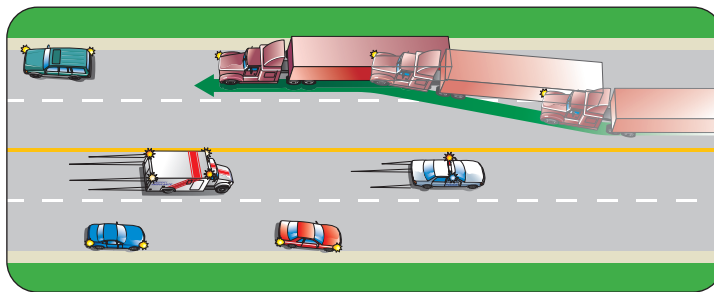

Stopped vehicles with flashing lights

Drivers must slow down and leave plenty of room when passing stopped vehicles displaying flashing lights to make highways safer for law enforcement, emergency personnel and other roadside workers. This rule applies to all vehicles authorized to display flashing yellow, red, white or blue lights, including those used by fire departments, law enforcement, commercial vehicle inspectors, conservation officers, paramedics, tow truck operators, highway maintenance workers, utility workers, land surveyors, animal control workers and garbage collectors.

When approaching these types of vehicles, you must drive no faster than 70 km/h if the speed limit is 80 km/h or more, and no faster than 40 km/h if the speed limit is less than 80 km/h. (Exception: this rule does not apply if you are on a divided highway and approaching the vehicle with flashing lights from the opposite direction.)

If you are in the lane nearest to the stopped vehicle displaying flashing lights, you must also change lanes to provide safe space margins if it is safe to do so.

Shifting gears

You're probably familiar with operating automatic transmissions. As a commercial driver you may operate vehicles with manual transmissions that have 10 or more gears. Heavy vehicles are usually powered by diesel engines equipped with engine fuel governors.

You need the knowledge, instruction and practice to operate large vehicle transmissions smoothly. Before you start out on any trip, you also need to be familiar with the shift pattern and shift points of your vehicle.

fast fact

If it's difficult to shift to the next gear after the transmission is left in neutral too long, don't try to force the shift. Instead, shift back to neutral, release the clutch and increase engine speed to match road speed. Then try again.

There are many different manual transmissions used in commercial vehicles, so only general information is given in this guide. Consult your manufacturer's manual for more information.

Knowing how to shift gears

Most heavy vehicles with manual transmissions don't have synchromesh gears and so it's essential that you become skilled at double-clutching.

Double-clutching

Double-clutching means depressing the clutch pedal twice in the process of moving from one gear to another. Shifting gears by double-clutching requires practice. Shifting to a higher gear is called upshifting, and is done when you want to go faster. Shifting to a lower gear is called downshifting, and is done as you slow down. Upshifting and downshifting with double-clutching are performed slightly differently.

To upshift, follow these steps:

1. Release the accelerator pedal. Depress the clutch pedal and shift to neutral at the same time.
2. Release the clutch pedal.
3. Let the engine and gears slow to the r.p.m. needed for the next higher gear.
4. Depress the clutch pedal and shift to a higher gear at the same time.
5. Release the clutch pedal and depress the accelerator at the same time.

To downshift, follow these steps:

1. Release the accelerator pedal. Depress the clutch pedal and shift to neutral at the same time.
2. Release the clutch pedal.
3. Depress the accelerator to increase the engine speed to the r.p.m. needed in the lower gear.
4. Depress the clutch pedal and shift to a lower gear at the same time.
5. Release the clutch pedal while maintaining constant pressure on the accelerator.

Knowing when to shift gears

At any given speed, the engine is developing both torque and horsepower. Torque is the ability of the engine to move the vehicle. Horsepower is used to develop speed. Peak torque is found at a lower engine speed than peak horsepower. The vehicle should be operated between the engine's peak torque and peak horsepower. This range is referred to as the normal operating r.p.m. range of the engine. To keep within the normal operating r.p.m. range, the transmission should be shifted according to the engine's peak torque and peak horsepower.

Shift the transmission progressively. To do this, use only enough torque to get the vehicle moving and then shift to the next higher gear.

Sometimes drivers can skip gears to achieve maximum speed more quickly.

fast fact

Lugging occurs when the engine is operated below peak torque for any length of time.

fast fact

Shift patterns and characteristics vary depending upon the engine and transmission. Check your vehicle operator's manual for information related to your vehicle.

driving tip

Smart driving techniques like progressive shifting, choosing the best driving speed, and proper braking techniques help to save fuel.

fast fact

If you need to apply the throttle with a diesel engine to move off with a loaded vehicle, you should be using a lower gear.

To shift gears smoothly, find the transmission's shifting range. A tachometer, which indicates engine speed, can help you decide when to shift.

Progressive shifting is recommended for many new vehicles with high-torque engines. The r.p.m. you need to shift at becomes higher as you select higher gears. For example, a manufacturer may recommend shifting from first gear to second gear at 1,200 r.p.m. and from fifth gear to sixth gear at 1,350 r.p.m.

Another shifting method is to use a standard r.p.m. split. For example, if the peak engine torque is at 1,500 r.p.m. and the peak horsepower is at 2,000 r.p.m., you can upshift by accelerating to 2,000 r.p.m., then double-clutching to enable the engine speed to decrease to 1,500 r.p.m., and then upshifting. This method may not be cost-effective and may be hard on modern engines. Refer to your vehicle manufacturer's guide book to decide which shifting method is best for you.

Shifting skills

This section will give you details about how to shift the gears of some common engines and how to shift gears on hills and curves. Large vehicles powered by gas or diesel have governors (speed controllers) which regulate the amount of fuel burned and engine r.p.m. Small vehicles don't have governors. The way you shift depends on whether your vehicle has a governor.

Shifting gasoline-powered (not governed) engines

Steps to upshift a vehicle with a gasoline-powered engine:

1. Start in low gear. Use only enough throttle to start the vehicle moving.
2. When the engine begins to accelerate, quickly shift to the next gear. Shift to higher gears as soon as you have the power.
3. As your vehicle's speed increases and you begin shifting into the higher gears, allow the engine to develop more power before each shift so the rate of acceleration increases.
4. As you complete each shift, engage the clutch smoothly, and engage the throttle at the same time. This allows for a smooth engagement and no shock on drive train components.

Shifting gasoline- or diesel-powered governed engines

An engine governor controls the amount of fuel going to the engine and regulates the speed of the engine. A governor lets you start a vehicle on level ground and on grades without using the throttle.

Always squeeze the throttle, rather than stabbing or jabbing at it. This will result in smooth acceleration or deceleration through the gears, just like smooth braking when you squeeze the brake pedal.

Use only enough power to shift the vehicle into the next gear. Depending upon your vehicle's weight and transmission gear ratios, you may be able to skip gears on down grades or level grades. Your engine's torque characteristics will let you know when you should shift to the next gear (usually when the engine begins to accelerate quickly). Engage the clutch smoothly when you complete each shift to avoid shocking the drive train, load or passengers.

Multi-speed rear axles and auxiliary transmissions

Many large vehicles have multi-speed rear axles and auxiliary transmission features to provide extra gears. Check your vehicle operator's manual for more detailed information.

Entering curves

Before you enter a curve, slow to a safe speed and downshift to a gear that lets you use engine power all through the curve. This will keep your vehicle stable and provide good acceleration as you leave the curve.

Passing and being passed

Passing or being passed by a heavy vehicle is very different than by a passenger car.

Large vehicles travelling at high speeds create air turbulence that can be hazardous to smaller vehicles. The larger your vehicle, the more wind turbulence. A car, bicycle or other road user travelling directly in front of a truck, alongside the cab, by the back area of the trailer or at the immediate rear of the trailer is in an area of air turbulence. For cyclists, the air turbulence from your vehicle can cause them to lose control.

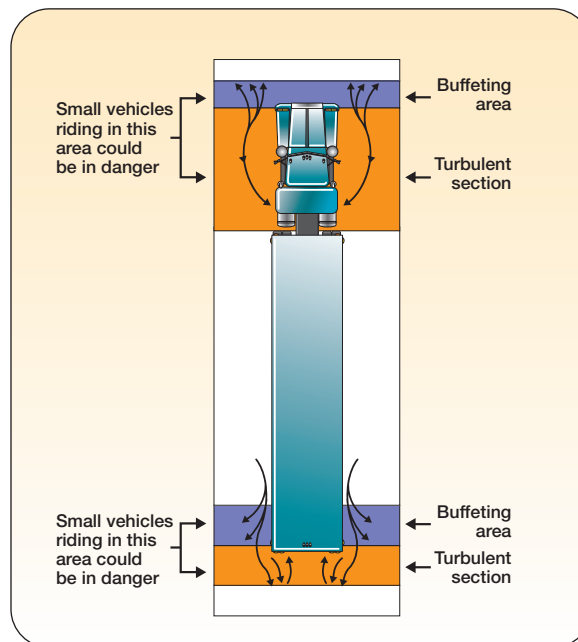

Areas of turbulence.

Be alert for road users who ride in these areas. They may be forced off a narrow roadway or drawn into the side of your vehicle. If a smaller vehicle continues to ride in your area of turbulence, slow down until it's out.



Use your four-way flashers to warn other drivers if you can't keep up with traffic. In some areas, these road signs are posted as a reminder.

The truck in the fast lane is blocking a faster-moving passenger vehicle.

Passing

Drivers often think big vehicles are travelling faster than they actually are. When you overtake or pass passenger vehicles, observe the speed limit and guard against startling inexperienced or nervous drivers.

Drivers often become frustrated when a commercial vehicle holds them up as it passes another commercial vehicle that's driving at almost the same speed. If the passing truck occupies the fast lane when it isn't absolutely necessary, traffic may become congested.

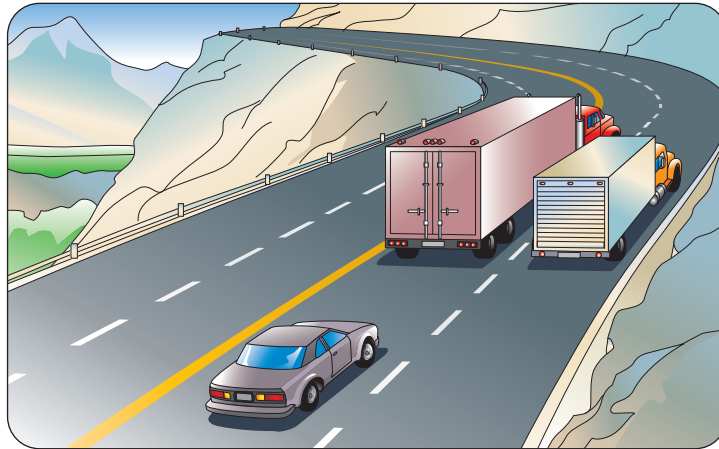

Being passed

By directing other drivers to pass, you may be encouraging them to risk a pass they can't complete safely. But when other drivers indicate they want to overtake your vehicle, help them to pass safely. Reduce your speed and give them room.

fast fact

Never use a trailer hand valve to hold an unattended unit. Over time the air may drain away and the brakes may release.

driving tip

You may need to leave the engine idling for three to five minutes to let it cool down after driving on the highway. Idling for any longer wastes fuel, increases emissions, and can clog fuel injectors.

For the first hour, the engine will actually stay warmer if it's turned off.

Parking

It's important to ensure your vehicle stays in place when parked. To prevent a runaway vehicle:

- Set the parking brake in the tractor.
- Place the transmission in the lowest forward gear, if parked facing uphill, or reverse gear if parked facing downhill, or park if the vehicle has an automatic transmission. If the vehicle has main and auxiliary transmissions, place both in gear. If the vehicle is equipped with a two-speed axle, the axle must be in low range.
- Apply the parking brakes on both the tractor and trailer.
- Most trailers equipped with air brakes also have spring brakes. If your trailer doesn't have spring brakes, apply the trailer brakes and block the wheels. Over time, the air pressure may bleed down and may cause the trailer brakes to release.
- If you're parking a single-unit vehicle on an uphill with a curb, turn the wheels to the left towards the centre of the road.
- If you're parking a single-unit vehicle on an uphill with no curb, turn the wheels to the right towards the edge of the roadway.

fast fact

Spring brakes are effective only when brakes are correctly adjusted.

- If you're parking a tractor-trailer combination on an uphill with or without a curb, always turn the wheels to the left towards the centre of the road.
- If you're parking any vehicle on a downgrade, always turn the wheels to the right towards the edge of the roadway.
- Stop the engine. Lock the ignition and remove the ignition key.
- You should block the wheels of any large vehicle parked on even a slight grade.

Crossings

Drivers must be constantly aware of the vehicles ahead, behind and beside them. Pay particular attention to the vehicles, cyclists and pedestrians at the crossings you drive through.

Intersections

Intersections can be confusing and all drivers need to know right-of-way rules (found in *Learn to drive smart*). Don't depend on other drivers to obey these rules. Follow these commonsensical practices:

The driver of the purple truck must yield the right of way to the red truck and wait until it has proceeded through the intersection before turning.

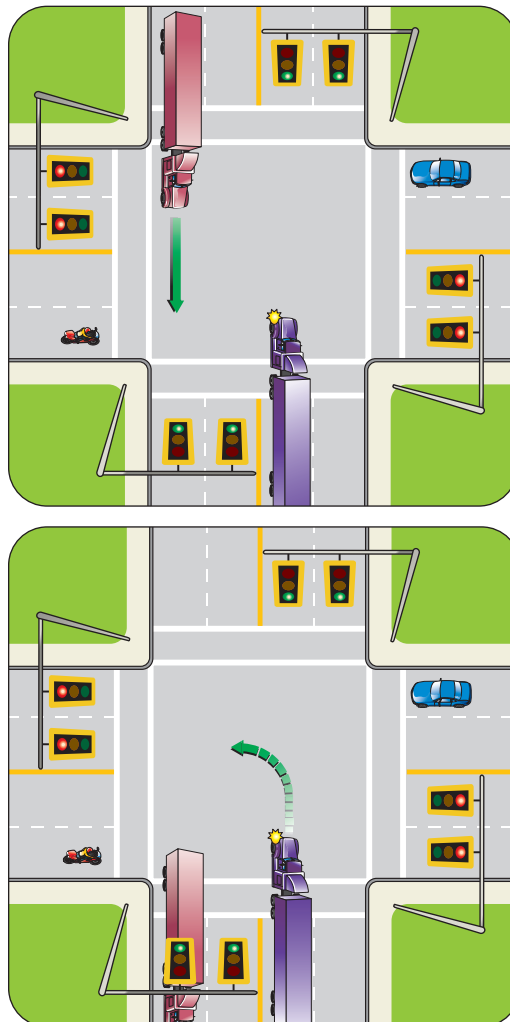

- Don't assume you have the right-of-way, even when your right-of-way is controlled by traffic signs or traffic lights.
- When you're planning to turn, get in the proper lane well before the intersection and signal other drivers to show them you intend to turn. Reduce your speed gradually before entering the intersection. Turn only when it can be done safely, and your path is clear of other traffic and pedestrians.
- Look left and right before entering any intersection. Look for and expect someone to run the sign or lights.
- Enter a limited-view intersection at a speed that allows you to stop if you need to.
- Look ahead for stale green lights. Expect them to change. Decide in advance whether you'll have to stop to avoid running through the light.
- When the light turns green, check left, right and ahead for any latecomers before you enter the intersection.
- Don't depend on other drivers for your safety: they may forget to signal; they may signal and not turn; they may turn into a wrong lane; or they may fail to yield.
- Don't change lanes, pass or overtake other vehicles as you are approaching or going through an intersection.
- Give full attention to each and every intersection, lane and driveway. Keep your vehicle under full control.
- Don't use your vehicle's size to force other road users into giving you the right-of-way. Give the right-of-way; don't try to take it. Move only when you're certain other road users have given you the right-of-way.

fast fact

The maximum speed in a lane or alley is 20 km/h unless otherwise posted.

You must stop and yield the right-of-way when pulling out of an alley.

Alleys, lanes and side roads

If you drive from an alley, lane or side road onto a highway, you must:

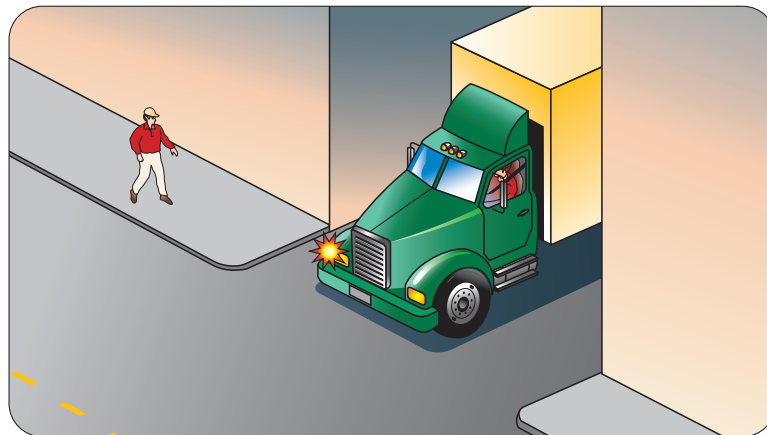

- Stop your vehicle before you drive across the sidewalk or sidewalk area.
- Yield the right-of-way to pedestrians in the sidewalk area and to motor vehicles on the highway.

Railway crossings

Large commercial vehicles need more space and more time to respond if a train is in the area. Also note the condition of the track and whether your vehicle will have any difficulty getting across.

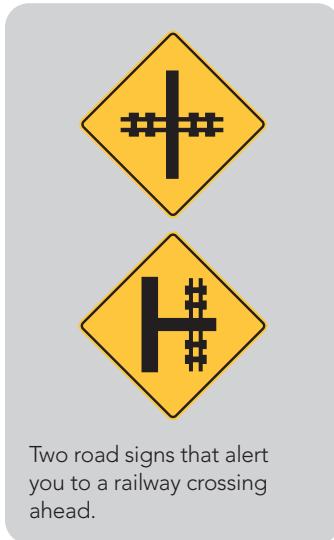

fast fact

Uncontrolled main railway crossings don't include industrial tracks in a business or residential district or railway spur lines.

Controlled and uncontrolled crossings

All vehicles must stop at controlled railway crossings if signalled to do so. A controlled crossing has a flag person, stop sign, crossing gate or an electric or mechanical signalling device.

When you stop for a railway crossing:

1. Stop five to 15 m from the railway crossing.
2. Look both ways and listen for any approaching trains — opening your driver's side window or bus passenger loading door will help you hear better.
3. Move forward when safe. Don't shift gears while crossing.

Don't park any vehicle within 15 m of the nearest rail of a railway crossing.

Don't ever cross a railway track if a railway crossing gate is down.

Vehicles that are required to stop at all uncontrolled main railway crossings are:

- school buses carrying children
- buses carrying passengers
- vehicles transporting explosive, poisonous or flammable substances as cargo or as part of their cargo
- vehicles used to transport combustibles or corrosive liquids, or liquefied petroleum gas, whether empty or loaded.

Crossing in a large vehicle

Crossing railway tracks can be especially hazardous when you're driving a large vehicle because:

- Longer trucks need to travel further and will use more time to clear a crossing.
- Heavier trucks take more time and need more room to stop before railway crossings.
- Bigger vehicles can cause a train to derail if there's a collision.
- Larger vehicles often have low clearances which may cause trailers to hang up or to displace tracks.

Minimize your crossing time — Before you cross a railway line, check that the track is clear far enough to give you at least 10 seconds to cross — more if your vehicle requires it or if you're crossing more than one track at a time.

Things that can increase the time you take to cross railway tracks include:

- the weight and length of your truck
- dragging brakes
- laws and rules against shifting gears
- rough crossing surfaces
- approach grades
- the angle of crossing.

Before you begin to cross, be certain there's room for your vehicle on the other side of the tracks. Stopping on the tracks is extremely dangerous. You must not shift gears while crossing railroad tracks.

Watch for humpback crossings — Over time, humps can form at railway crossings and present a danger to many low-clearance vehicles because:

- low bed trailers may hang up on the crossing surface or the rails
- low-hanging trailer appliances (for example, dolly wheels and tool boxes) may catch on the rail.

Crossing more than one track — Take extra caution when crossing more than one track. There may be other trains. Don't assume that the train you can see is the only one in the area.

Railway crossings at rural roads — Pay extra attention when you cross railway tracks in rural areas because:

- approach grades may be steeper
- snow banks may be higher
- brush can affect visibility
- there are fewer automated warning systems
- there may be more humpback crossings.

The truck driver stopped at this controlled railway crossing because the red light was flashing. The driver must not cross the tracks until it's safe. Remember, it takes larger, heavier vehicles much longer to cross railroad tracks than smaller, lighter vehicles.

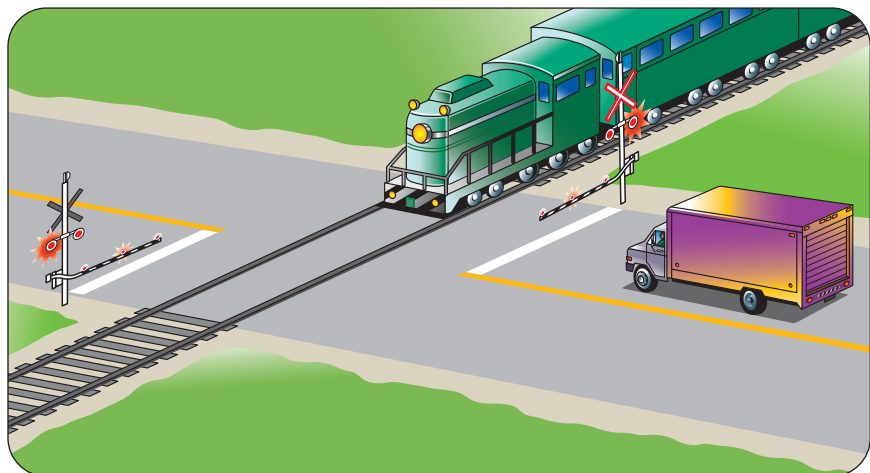

Acts of nature

No matter how well you prepare yourself and your vehicle, there will always be conditions beyond your control. These include weather conditions and the hazards brought on by darkness.

fast fact

About one in 25 crashes involve wildlife. On average, four people are killed and 450 are injured every year in collisions where animals were a contributing factor.

(TAS 2015)

Each year, over 4,700 wild animals including deer, moose, elk, bears and coyotes are reported killed by collisions with vehicles.

*B.C. Ministry of
Transportation statistics*

Animals on the road

In B.C., animals on the road are a major hazard. Crashing into a large animal can cause damage and injury, not just to the animal, but to you and your passengers.

To help prevent a collision with an animal:

- Watch for animal crossing signs. Slow down in these areas.
- Slow down and use caution when you see wildlife on or near a highway, so you can react in case it crosses your path.
- Be alert, especially at dusk or dawn.
- Look for sudden, unusual spots of light on the roadway at night. This may be the reflection of your headlights off an animal's eyes.
- Take extra caution in spring and fall — vegetation growth in the ditches along the side of the road in spring is an attractive source of forage for many wildlife species, and in fall, many animal species are on the move during the mating season.
- Remember that wild animals often move in herds. If you see one animal, there may be more.

If an animal is directly in front of you:

- Check your rear-view mirror to see if there's a vehicle behind you.
- Assess the risks and decide on an action. Can you stop safely? Would vehicles behind you be able to stop safely? Can you steer around the animal? Would it be better to hit the animal and risk a crash?
- Slow down but resist the urge to slam on your brakes. This could send your vehicle out of control.
- Leave a wide margin when you drive around an animal. A frightened animal may run in any direction.
- If the animal is large and you can't stop in time, brake firmly and steer to strike the animal at an angle. Let up on the brake pedal just before hitting the animal. This will cause the front of your vehicle to rise and reduce the chance that the animal will come through the windshield.

Weather conditions

Good drivers ensure their vehicle is properly equipped for weather hazards and know when conditions are too dangerous to risk driving.

To adjust to ice, sleet or snow, you need to:

- Get the feel of the road when you start out. At a slow speed, test the steering and brakes for control.

driving tip

Make sure you know how to use your vehicle's heater and defroster controls. Some heater defrosters have a position to allow for recirculating the air in the vehicle's interior. But don't use this position in cold weather — it can cause windows to fog up.

- Reduce your speed to suit ice or snow conditions. Put on chains if necessary.
- Apply light pressure to your brake. Avoid moving the steering wheel in a quick or erratic manner.
- Keep your windows and windshields clear, inside and out. Maintain wiper blades and lights in good working order. Use the heater/defroster controls to avoid windows fogging. Be sure you can see and be seen.
- Be sure your ventilation is good and your exhaust system has no leaks.
- Stay alert for hazards ahead of your vehicle, including pedestrians, cyclists, ice patches, bridge surfaces, blind intersections, snow plows and graders.

Night driving

You can't see as far in the dark. Travel at a speed that allows you to stop within the distance you can see — even if it's below the posted speed limit.

Most headlights illuminate the highway for only 100 m on high beam and less on low beam. Poor weather, glare and fatigue will reduce how far you can see. Adjust your speed for the conditions.

Even when you travel at the legal speed you can overrun your lights. For example, a large, loaded truck travelling on a highway at 80 km/h can take more than 100 m to stop — further than your high beams will allow you to see under good conditions. Slow down to ensure you can see problems developing in time to stop.

Some tips for driving at night:

- Reduce your speed after sunset. Remember, your vision isn't as efficient as it is in daylight.
- Ensure your lights are clean and working — see and be seen.
- Use parking lights only for parking. It's illegal to drive at night using only parking lights.
- Switch your lights from high beam to low beam at least 150 m away from any vehicle you're approaching or following to reduce glare on the eyes of other drivers.
- Don't flash your lights at drivers who forget to switch their lights from high beam to low beam. Instead, slow down and focus your eyes on the right edge of the road to watch for pedestrians and obstacles.

These two vehicles are approaching each other at night in opposite directions with their lights on low beam.

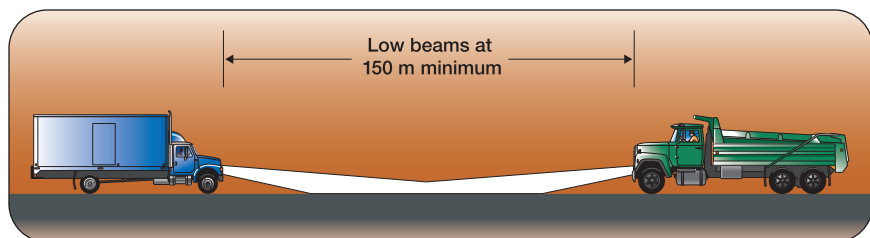

fast fact

Driving on a flat tire may cause more damage — including a tire fire — and could mean you will have to replace the tire rather than have it repaired. Tires that have caught fire could spread to your truck or trailer.

fast fact

If you reduce a tire's air pressure when it's warm, you may upset the cooling balance and cause the tire to generate more heat.

fast fact

When the amount of contact between the tire and the road surface is reduced, steering control is also reduced.

driving tip

Driving at 110 km/h can reduce tread life by 20 per cent compared to driving at 90 km/h.

The faster you drive, the more fuel you will use.

Vehicle safety

Keep your vehicle in top condition at all times. Your tires, wheels and lights need to be in good working order.

Tires and wheels

Don't drive a vehicle with its tires, wheels or rims in poor condition — it's extremely dangerous and illegal. Inspect your tires, wheels and rims before every trip.

Tire pressure

The rolling of your wheels as you drive cause your tires to flex, creating friction and generating heat. Usually, tires release this heat to the air around them.

If your tires are the correct size and are correctly inflated, and if your vehicle is not overloaded, the heat generated by your tires shouldn't cause any problems.

If your tires are not properly inflated at the start of a trip, you risk tire damage or even a blowout because of excessive heat buildup. A major cause of failure in recapped (retread) tires is underinflation.

If your tires are underinflated, your load is too heavy or you're driving too fast, your tires will flex more. More flexing means more heat. Too much flexing can cause your tires to overheat and the tire air pressure to increase. If this pressure rises too high, your tires could burst.

Manufacturers put a load rating on their tires. Check what these ratings are for your tires. Keep the weight of your vehicle and load below the rating for any individual tire or any group of tires on a single axle.

Check and adjust tire pressure when tires are cool. Use a tire pressure gauge. If a tire has the correct pressure when it's cool, it will generate a normal amount of heat during use. This will reduce the amount of wall flexing, which also keeps heat buildup under control.

Tire wear

Improperly inflated tires also cause your tires to wear out more quickly and may reduce the amount of steering control you have.

Overinflating a tire causes excess wear in the centre part of its tread. An overinflated tire has less tread surface in contact with the road surface. Less contact between your tire and the road means less traction.

Underinflating a tire causes excess wear on the outer edges of its tread. In wet conditions, an underinflated tire will not squeeze the water out from between the tire and the road as well as a properly inflated tire and has a greater chance of riding on a film of water (hydroplaning).

Tire condition

Various types of tire wear patterns.

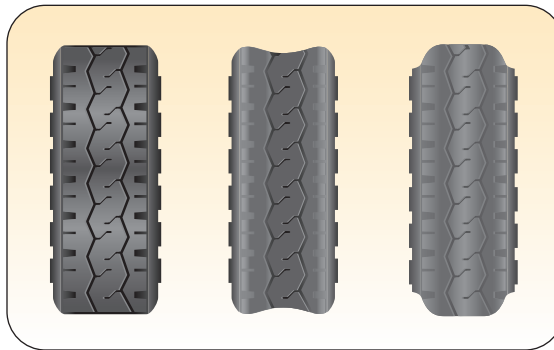

Never operate a vehicle that has bald or damaged tires. Tires are defective if they:

- have any tread damage, including cuts, cracks or snags, that are longer than 2.5 cm (1 in) and deep enough to expose the ply cords
- have less than 3 mm (1/8 in) of tread on a front tire or 1.6 mm (1/16 in) of tread on a rear tire and are being used on a vehicle with a GVW of 5,500 kg or more

Ensure the tread depth on your tires conforms to the standards set out in the Motor Vehicle Act Regulations.



- have less than 1.6 mm (1/16 in) of tread and are being used on a trailer
- have less than 3.5 mm (3/16 in) of tread in the case of a winter tire.

For more details on tire requirements, consult the *Motor Vehicle Act Regulations*.

Tire problems

Here are some common tire problems:

- too much or too little air pressure — use a gauge to ensure correct pressure
- tire wear — check for tread depth and tread recap separation
- cuts, abrasions, exploding cord, sidewall separation or bulges
- tires in contact with each other or tires in contact with any part of the vehicle
- cracked or leaking valve stems
- a mixture of different sizes or radial and bias-ply tires being used on the same axle — these can be mixed on the same vehicle but not on the same axle (not a recommended practice).

Note: If you change a tire, stop after a short while and check that the wheel nuts are tight. Always use a torque wrench to tighten and check wheel nuts.

fast fact

Wheel separations are usually caused by loose wheel fasteners or broken wheels/rims, or by wheel bearing failure.

fast fact

Rust streaks on the rim may indicate a loose lug nut or cracks in the rim.

Disk wheel problems

Check your wheels before every trip. If you have disk wheels, don't drive if you find:

- loose or missing lug nuts
- stripped studs
- cracks in the rim.

If you find any of the following, investigate and decide whether immediate attention is needed:

- metal or paint flakes around the nuts — may indicate wheel movement
- oil or grease leaks from the hub — if you see oil or grease, check the brake drum area to see if there's oil or grease on the brake pad.

Cast spoke wheel problems

Check your wheels before every trip. If you have cast spoke wheels, don't drive your vehicle if you find:

- missing or loose nuts or rim clamps
- cracks on the rims or hubs.

If you find any of the following, investigate and decide whether there's a problem that needs immediate attention:

- mismatched, bent or cracked lock rings
- oil or grease leaks from the hub — if you see oil or grease, check the brake drum area to see if there's oil or grease on the brake pad
- wear on the rim near the clamp or a valve stem that's too close to a spoke — may indicate that the rim has shifted
- rim damage — could allow the tire to lose pressure or come off.

Brake failure warning devices

All vehicles using air or vacuum brakes must be equipped with warning devices that will warn the driver if the air-pressure or vacuum system fails.

Braking systems

Every motor vehicle must be equipped with at least two separate braking systems. One of these systems must be mechanical, for example a ratchet and pawl (notched wheel) or spring brake mechanism. If the foot (primary) brakes fail, the driver must use the emergency (mechanical) brake, which requires more time and distance to stop the vehicle.

fast fact

You must have a permit from Commercial Vehicle Safety and Enforcement before you mount amber flashing lights on a vehicle.

A police vehicle has both red and blue flashing lights.

Flashing lights

Flashing lights may be mounted and used on motor vehicles under the following conditions:

- red flashing lights are used only on emergency vehicles
- blue flashing lights are used only on police vehicles
- amber flashing lights are used on construction vehicles, towing vehicles, tow cars that are attending, snow-removal equipment, sanding equipment, pilot cars, and vehicles that are required by permit to use them, such as some oversize vehicles or vehicles carrying oversize loads (see **chapter 5, skills for driving trucks and trailers**).



Disabled vehicles

Any vehicle is a hazard when it's parked on the side of a road. Large vehicles present more significant hazards. In most cases, drivers are required to put out approved warning devices when they park their commercial vehicles at the side of the road in an area that isn't designated for parking.

These commercial vehicles must carry approved warning devices:

- all vehicles with a seating capacity of more than 10 passengers
- all commercial vehicles with an overall width of more than 2.3 m
- all commercial vehicles with a load width of more than 2.3 m.

When parked in the dark, these commercial vehicles must have a minimum of two warning devices.

During daylight hours, the minimum for approved warning devices is:

- two red flags that measure at least 30 cm by 30 cm, or
- two warning devices that have been approved for daylight use — including flares, fuses and reflectors.

At night, you may use flares, fuses, reflectors *and* red lanterns.

If your vehicle becomes disabled:

- move it as far off the travelled portion of the highway as possible
- place warning devices approximately 30 m ahead and 30 m behind the disabled vehicle.

Note: It's a good safety practice to place additional warning devices further than 30 m from your vehicle.

driving tip

Recommended safety equipment:

- flags or flares
- fire extinguisher
- first aid kit.

You never know when you might need it.

fast fact

Only approved warning devices should be used to mark the location of disabled vehicles.

If your vehicle becomes disabled, park as far off the road as possible. Place warning devices 30 m ahead and 30 m behind the vehicle.

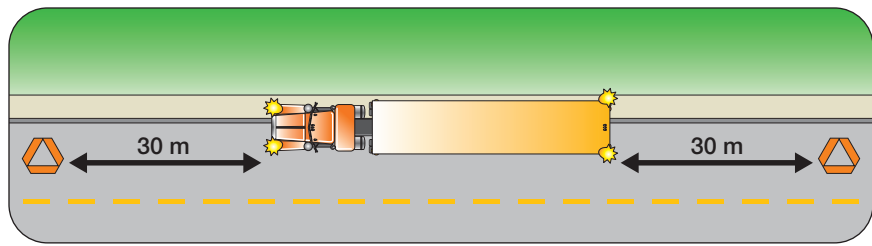

Personal safety

Commercial vehicle drivers must be concerned with their personal safety to protect themselves and others on the road. This section covers information on carbon monoxide poisoning, seatbelts and head restraints, cellphone use, fatigue and impairment, and vehicle and cargo fires.

Carbon monoxide poisoning

Carbon monoxide poisoning is an ever-present danger when you operate a motor vehicle. It can seep into a driving compartment and make you dizzy or drowsy. Too much of it will make you pass out, which will almost inevitably result in a crash if you're driving. It can kill you if you continue to breathe it in after you pass out.

Carbon monoxide is especially dangerous because it's odourless, colourless, tasteless and difficult to detect. It's in the exhaust of every motor vehicle. Because it's so difficult to tell when it's present, always check your exhaust system to ensure that exhaust fumes aren't entering the driver's compartment of your vehicle.

Never run your engine in a closed garage. Don't follow any vehicle too closely, and maintain a safe distance between your vehicle and the one in front of you when you're stopped at traffic lights or stop signs.

If you feel dizzy or drowsy while driving, pull over to the side of the road. Stop. Get out and get plenty of fresh air.

Seatbelts

There's no question — seatbelts save lives. Transport Canada estimates that wearing seatbelts has saved an estimated 2,400 lives and prevented 55,000 injuries in the past 10 years.

Drivers who get in and out of their vehicles frequently as part of their work may be exempt from wearing seatbelts while they're driving at 40 km/h per hour or less. Exemptions include inner-city delivery, bus and emergency vehicle drivers. From a safety perspective, wearing a seatbelt always makes sense.

During a crash, seatbelt systems reduce the risk of occupants striking the interior of the vehicle, colliding with other passengers or being ejected. If you're belted in, you're much less likely to become injured or knocked out in a collision. Staying conscious gives you a better chance of getting out of your vehicle quickly if it catches fire or lands in water. Even during normal driving conditions, a seatbelt can help you maintain better control on rough roads or during collision-avoidance manoeuvres.

fast fact

It's estimated that the correct use of a lap and shoulder belt system reduces the likelihood of death in a motor vehicle crash by 50 per cent.

Many people think they can protect themselves in a collision. You can't hold yourself back during a collision, no matter how strong you are.



Wear your seatbelt correctly to provide maximum protection.

Thousands of kilograms of force work against unbelted persons during the rapid deceleration that takes place during a crash.

Adjust your seatbelt correctly by:

- placing the lap belt low over the pelvis, not over the soft stomach area — make sure it's snug
- ensuring the shoulder strap is snug across the chest
- never placing the shoulder strap under the arm or behind the back
- removing all slack.

Airbags and head restraints

Most large trucks aren't equipped with airbags and head restraints.

Even if your vehicle's equipped with airbags, you must wear your seatbelt. Airbags can seriously injure unbelted occupants. You must allow at least 25 cm (10 in) between your breastbone and the airbag unit in the steering wheel. This distance will minimize the risk of injury if the bag deploys.

If your vehicle has head restraints, it's important to adjust them to fit correctly. This will reduce the risk of neck and back injuries during a rear-end crash. By simply making sure the top of the head restraint is at least as high as the top of your head, and the head restraint is less than 10 cm from the back of your head, you can help prevent neck injuries.

crash fact

Cellphone use while driving is the number one cause of distracted driving. On average, 81 people die each year in B.C. as a result of distracted and inattentive driving.

(TAS 2010–14)

Cellphones and other devices

Research shows that using a cellphone or other electronic communication device while driving significantly increases the risk of crashing.

All drivers in B.C. are prohibited from using hand-held electronic devices while driving. Drivers are prohibited from operating or holding hand-held cellphones or other electronic devices, sending or reading e-mails and/or text, operating or holding hand-held music or portable gaming devices, and manually programming or adjusting GPS systems while driving. Drivers in B.C.'s Graduated Licensing Program (GLP) are also restricted from operating hands-free devices. These restrictions do not apply for calling 9-1-1 to report an emergency.

Non-GLP drivers, including commercial drivers, are permitted to use hands-free cellphones and devices that only require touching a single button to activate or deactivate, and where that single button is located in a fixed and secure location. This includes pre-programmed or voice-activated GPS devices. Two-way radios and mobile data terminals are also permitted.

Even if you need to make or receive a hands-free call, it's safer to pull over to the side of the road as soon as it's safe to do so.

fast fact

B.C. has tough drinking and driving laws. Penalties can add up to \$600 to over \$4,000 — even if it's the first time you're caught — and more time off the road.

For more information on B.C.'s impaired driving laws, go to icbc.com, the RoadSafetyBC website and the Justice Laws Website.

Impairment



fast fact

If you're convicted of impaired driving and you caused a crash, the cost of your vehicle insurance will increase. In addition, ICBC will not pay to repair or replace the vehicle. ICBC can also recover from you all costs associated with the crash, including any victim's claim.

As a professional driver, your life and the lives of others depend on your ability to remain alert and fully functioning when you're behind the wheel. Alcohol, illicit drugs (for example, marijuana and cocaine), and even some prescribed drugs or stay-awake tablets can reduce (impair) your ability to function safely.

You risk a lot by driving impaired. There are penalties under British Columbia's *Motor Vehicle Act* and under the *Criminal Code of Canada*. More immediate and severe penalties apply if:

- you drive with a certain amount of alcohol or drugs in your system, or
- you refuse to provide a breath sample.

As well, the penalties become more severe for repeat offences.

Note: You may be prohibited if a police officer considers your ability to drive to be affected by alcohol or drugs. You don't have to have a BAC level of over .08 or a BDC of 2 nanograms or more THC.

Criminal Code penalties

If you're convicted of a *Criminal Code* driving offence for impaired driving due to alcohol or drugs, you're looking at some very serious penalties which could include lifetime driving prohibitions and time in jail.

	Driving while impaired or Blood Alcohol Content (BAC) over .08 or refusal to provide sample			Impaired driving causing bodily harm	Impaired driving causing death
	1 st Offence	2 nd Offence	3 rd Offence		
Prohibition from driving	1–3 years	2–5 years	3 years – lifetime	Up to 10 years	Up to lifetime
Fine	\$1,000 and up	No maximum	No maximum	No maximum	No maximum
Jail	0–5 years	30 days – 5 years	4 months – 5 years	Up to 10 years	Up to life imprisonment

fast fact

If you drive while prohibited, you may face significant penalties including a stiff fine and jail.

Other costs of impaired driving

Besides the penalties listed above, there are other costs involved if you are caught riding or driving while impaired:

Money — If you're convicted of impaired driving and you cause a crash, your insurance claim may be denied, including claims for damage that you might cause to your vehicle, or to other people or property. You could be responsible for paying these costs. As well, your insurance rates will increase and you'll receive a driver penalty bill.

Job — An impaired driving conviction can prevent you from holding certain jobs.

Travel — An impaired driving conviction could create problems for you when travelling to certain countries, including the U.S. and Mexico.

Vehicle impoundment

In addition to impounding vehicles operated by impaired drivers, police can also impound the vehicle you're driving if you're caught committing any of the following offences:

- driving while unlicensed
- driving while suspended or prohibited
- excessive speeding (40 km/h or more over the posted limit)
- street racing or stunt driving.

Police can immediately impound the vehicle for seven days, which could escalate to 30 or 60 days for repeat offenders. The owner is then required to pay the vehicle towing and storage fees to get their vehicle back.

It's important for vehicle owners to understand that they are responsible for making sure that only licensed drivers use their vehicles. For example, if an employer allows a prohibited or unlicensed driver use of a company vehicle, the vehicle could be impounded.

Prescribed and over-the-counter drugs

Using medication when you drive is particularly risky. Antihistamines, sedatives, tranquilizers and even some cold remedies can cause drowsiness and decreased alertness. Read the warning on the label for any side effects that may impair your ability to drive safely. Check with your pharmacist or physician if you have any questions. Certain combinations of medications can also affect your driving ability.

Fatigue

Long road trips and driving day after day can easily fatigue you. Over time this can lead to chronic fatigue. Stay-awake tablets may keep you physically awake but they don't necessarily reduce mental fatigue, which affects your ability to make good decisions.

There's no safe substitute for proper rest or sleep. If you're relying on stimulants like coffee to stay awake, or if you're having trouble sleeping, you're likely suffering from fatigue. Pull over in a safe location and get some sleep. To help yourself get enough rest and stay alert, follow the hours of service regulations set by the National Safety Code (see **chapter 7, hours of service requirements**) and be sure to get enough sleep every 24 hours.

Emotions

Your emotions can prevent you from focusing on the task of driving.

Safe driving demands your full attention at all times. Arguments at home or at the terminal, annoyance with other drivers, illness or financial problems are some of the things that can distract you from the important job of driving.

Your safety and your livelihood depend on your ability to stay calm and focused when you're behind the wheel. There's no room in the cab for road rage or any other distracting emotion.

Fire

To help prevent fires in and around your vehicle:

- Never start a vehicle with a fuel leak. Repair the leak and use an appropriate absorbing material to soak up the spilled fuel. Dispose of your cleaning material properly.
- Shut off engines when refuelling vehicles.
- Keep the nozzle of the fuel hose in contact with the filler pipe on your vehicle at all times when refuelling to ground the connection. If there's a ground strap, also connect it to the filler pipe.
- Don't smoke in garages or near fuelling areas.
- Never throw cigarette butts out of cab windows — they could blow back into tarps or loads.
- Check your tire pressure often. Soft tires build heat and can cause a fire. If your vehicle had a tire that was soft or flat when you last moved it, make sure the tire is cool. Check the pressure before the vehicle is moved again. If you must move the vehicle, the tire should be removed and replaced.

fast fact

If your vehicle has a fuel leak, a peace officer may order your vehicle out of service until the leak is repaired.

fast fact

Diesel fuel is toxic — don't touch it or clean it up with a cloth.

- Ensure all your vehicle's brakes, including the parking brake, are fully released when your vehicle is moving. Dragging brakes generate heat which can ignite grease in the hubs when the vehicle stops. Check your hubs and brake drums often for overheating.

It's always a good idea to keep a fire extinguisher in your vehicle. Some commercial vehicles are required to carry firefighting equipment.

Firefighting

Fighting a fire requires quick thinking and fast action. If your vehicle carries firefighting equipment, check it daily. Make sure you know how to use any fire extinguishers you carry and what types of fires they can extinguish. Learn any fire hazards associated with your vehicle or with the loads you carry.

To reduce the risk at a fire, follow these general guidelines:

- Don't risk your own life. Fuel fires can spread quickly or explode.
- Tell the first spectator to call the fire department. Warn others if there is any danger of an explosion, or exposure to toxic substances. Tell them to keep at a safe distance.

Assess the situation and decide whether it's safe to take any further action:

- If a fire is on a combination unit, disconnect the tractor from the trailer and separate the units. Do this only if it doesn't put you in danger.
- Fight fires with the wind at your back if possible. This reduces the chances of being asphyxiated.
- If the fire is in the electrical system, disconnect the battery cables. When a vehicle is in a crash, shutting off switches and disconnecting battery cables can prevent fuel fires.
- If a fire starts under the hood, direct the extinguisher from underneath the vehicle or through the radiator. Don't open the hood to fight the fire.
- Use your extinguisher to put out the flames, but try to keep some extinguishing fuel in reserve in case of flare-ups.
- Don't use water on gasoline or oil fires. Water will spread these fires. Use an appropriate extinguisher, sand or dirt to smother them.

Fire extinguishers

There are two main categories of fire extinguishers: multi-purpose dry chemical extinguishers and carbon dioxide (CO₂) extinguishers. The multi-purpose dry chemical extinguishers are easier and safer to use, but the CO₂ extinguishers are more effective.

Multi-purpose dry chemical extinguishers are available in two classes. If its cylinder is marked BC, it can be used to put out grease, oil, gasoline and electrical fires. If its cylinder is marked ABC, it will also put out Class A fires such as paper, cloth, etc.

CO₂ extinguishers are extremely effective but should never be used in an enclosed space. You could smother yourself if you use these in a confined space. You could also blister your skin.

fast fact

You must be properly trained before you carry any dangerous goods.

Vehicles required to carry fire extinguishers

One fire extinguisher must be carried on:

- limited passenger vehicles that have an authorized seating capacity of more than 10
- all public passenger vehicles
- all school buses — the fire extinguishers must meet Canadian Standard Association (CSA) Standard D250.

Vehicles transporting explosives must carry two fire extinguishers.

Review questions

1. What rule should you follow to maintain a safe following distance when operating a taxi, ambulance or a van?
2. What rule should you follow to maintain a safe following distance when operating a bus, truck or truck-tractor and semi-trailer?
3. Why should a commercial vehicle travel in the right (slower) lane of traffic?
4. As your speed increases, the length of your danger zone increases. What other conditions increase the length of your danger zone?
5. What determines the amount of off track a vehicle will have?
6. Why is it dangerous to allow the rear wheels of your vehicle to cross the centre line of the roadway when you negotiate a left turn or curve?
7. What are the risks of running rear wheels over curbs when making sharp turns to the right?
8. What precautions must you take before and while you're making a turn?
9. What special precautions must the driver take when it's necessary to "block off" more than one lane of traffic to negotiate a sharp turn?
10. What should a driver do before entering a narrow bridge from a curved approach?
11. What are some of the steps you can take to help avoid crashes when backing up?
12. Describe how and when you upshift and downshift.
13. How can the area of air turbulence around your vehicle endanger other users on the road?
14. As a professional driver, what can you do to help other drivers safely pass your vehicle?
15. Which vehicles must stop at all uncontrolled railroad crossings?
16. What are the dangers of driving a vehicle with underinflated tires?
17. How does the *Motor Vehicle Act Regulations* define a defective tire?
18. What do you do if your commercial vehicle becomes disabled?
19. Which types of commercial vehicles are required to carry fire extinguishers?

This chapter focuses on fuel-efficient driving techniques for large diesel-powered commercial vehicles. Many of these techniques can also be applied to smaller commercial vehicles such as taxis and small buses.

What you'll learn

After studying this chapter you'll be able to:

- describe fuel-efficient driving techniques to drive smart and save money
- describe vehicle maintenance practices that help conserve fuel
- describe commercial vehicle components and features that help make a vehicle more fuel efficient.

fast fact

Nearly 30 per cent of all greenhouse gas emissions are produced by motor vehicles.

Fuel efficiency — a growing priority

Drivers and transportation companies want to control fuel costs. And the environment is also a consideration. Nearly 30 per cent of all greenhouse gas emissions in Canada are produced by vehicles.

There are many ways to be a more fuel-efficient driver.

Making smart choices

Your driving habits affect how much fuel you use, how often you need to refuel, and vehicle maintenance costs.

Fuel-efficient driving techniques can improve fuel economy by up to 30 per cent. Fuel-efficient driving is also safe driving. By looking ahead, keeping good space margins and anticipating road hazards, you can avoid sudden stops and changes in speeds. These and other smart driving habits also save on fuel and maintenance costs.

Smart driving practices

Smart fuel-efficient driving is more than how you use the throttle when driving your vehicle. It includes:

- Planning and preparation for your trip.
- Proper vehicle maintenance and inspections.
- Using proper techniques to start your vehicle.
- Proper driving techniques.
- Reducing idle time.

Preparation and planning

Fuel

Use the correct fuel for the season. Summer fuel can improve fuel economy by as much as three per cent, but can cause engine problems in cold weather.

Think about where you'll be driving. For example, if you delivered a load to California in the winter and refuelled to return to the B.C. interior, that fuel may not be appropriate for B.C. winter temperatures.

Consider using biodiesel fuel. It provides power similar to conventional diesel fuel, but contributes less carbon dioxide or sulfur to the atmosphere, and is low in particulate emissions.

fast fact

Choosing to drive on a flat multi-lane highway improves fuel efficiency by:

- four to 11 per cent compared to a flat two-lane highway
- as much as 18 per cent compared to a mountainous highway
- 25 to 35 per cent compared to driving on suburban roads.

Route planning

Plan your route carefully. The most fuel-efficient route is often one that avoids heavy commuter traffic, busy city driving, and hills.

Flat routes are more fuel efficient than mountainous routes. Highway driving is more fuel efficient than driving on congested city streets.

Dealing with the weather

Weather conditions affect fuel efficiency. Driving on snow-covered roads can increase fuel consumption by 15 to 20 per cent.

Here are ways to minimize the effects of weather:

- Pay attention to weather forecasts. Plan your route to avoid bad weather where possible by changing trip times or routes.
- Adjust speed to suit conditions like when there's a strong headwind.
- Slow down and maintain a safe following distance.

Starting

Fuel efficiency begins when you start the engine. Proper warm-up helps lubricate engine components, reducing wear and leakage, and saves fuel costs. Here are some suggested techniques for starting heavy-duty diesel engines:

- Use zero throttle (keep your foot off the accelerator).
- Don't pump the throttle — it isn't effective and wastes fuel.
- Let the engine warm up for three to five minutes only or seven to 10 minutes if the temperature is below 0° C. Any longer wastes fuel and can cause engine damage. Don't use the throttle — let the engine warm up gradually.
- Check that oil and air pressure rise to their normal operating ranges.
- If you add ether when operating in cold temperatures or to help start the engine, use it sparingly. It can damage the engine. Before adding it, check the owner's manual to see if it's permitted.

Smart driving techniques

Proper driving keeps you safe on the road and reduces fuel consumption.

Start out easy

- After starting the engine and letting it warm up, accelerate slowly, keeping the engine speed (rpm) down for several kilometres.

Choose the right gear

- Select a gear that doesn't require using the throttle.
- Practise progressive gear shifting. Shifting before you reach the maximum governed rpm reduces engine wear, decreases noise and saves fuel.
- Run the engine in the highest gear range to keep it in a low rpm range.
- Change gears smoothly. Shifting properly can improve operating costs by 30 per cent.
- Always use the clutch. Failing to use the clutch can wear down the teeth on the gears in the transmission.

Ease off the throttle

- Back off the throttle when going over the top of a hill and select a lower gear to go down the hill.
- Use cruise control in appropriate locations. It can reduce fuel consumption.
- Reduce your average speed — driving faster consumes more fuel.
- Use the retarder properly. Turn it off when you don't need it — let the terrain work for you.

driving tip

Driving faster consumes more fuel. If you drive at 105 km/h instead of 90 km/h, you'll be travelling 15 per cent faster. But you'll consume about 20 per cent more fuel.

Use see-think-do

see — Scan for hazards and anticipate them. Pay attention to other road users and the areas where hazards could occur.

think — Decide which hazards are the most dangerous. Think quickly about possible solutions. Decide on the safest action.

do — Do manoeuvres to keep yourself and others safe.

Using see-think-do allows you to anticipate hazards and maintain a constant speed, avoiding unnecessary slowing and stopping. This maintains your vehicle's momentum, which means you don't have to build up lost speed. Power not used is fuel not burned.

Avoiding quick or sudden stops and starts is also smart, fuel-efficient driving.

Road and traffic conditions

Different road and traffic conditions present different challenges. As a professional driver, it's important to keep the following in mind.

- Adjust your driving to the visibility. Wear sunglasses to reduce glare in bright conditions in daylight, and reduce speed when driving in poor lighting conditions.
- Keep your seat properly adjusted to help keep you comfortable and alert, allow you to easily access the controls, see through the windows and use the mirrors.
- Keep your eyes moving to check for hazards. Look well ahead, and check your mirrors and blind spots frequently. This helps reduce sudden stops and starts and lane changes — and saves fuel.
- Listen to your radio and check highway display signs for news of traffic conditions.
- Maintain a safe following distance. Drivers of buses, trucks and other large heavy vehicles should never be less than five seconds behind the vehicle ahead at highway speeds. This allows you to gradually slow down or move over if needed, and avoids sudden changes of speed.
- Look ahead and anticipate stops. It's more fuel efficient to let off the throttle to gradually slow down than to apply the brakes at the last minute.
- Look ahead to anticipate traffic lights:
 - If you see a red traffic light that's been red for awhile, gradually slow down. If the light turns green before you arrive at the intersection, by not coming to a complete stop you save fuel.
 - On some major streets, traffic lights are timed so that if you drive at a certain steady speed, you may make all the lights, which saves stopping and starting and saves fuel.

fast fact

Idling can burn up to four litres of fuel per hour.

If fuel costs \$1.50 per litre, cutting one hour of idling per day would save over 1,000 litres of fuel and over \$1,500 in fuel costs per year.

Reduce idling

Contrary to popular belief, turning the engine off when you're not driving (for example, at a truck stop or depot) is more economical than leaving it running. Many trucks have auxiliary power units that can run the truck's air conditioning or refrigeration system.

Engine idling is simply a waste of fuel and money. Turn off the engine when you stop for any length of time. You'll save fuel, reduce maintenance, prolong engine life and prevent unnecessary emissions.

driving tip

Low-viscosity lubricants such as synthetic motor oil can improve fuel economy by up to four per cent.

Regular maintenance helps the fuel efficiency of your vehicle.

Maintaining your vehicle

Regular maintenance keeps your vehicle running well, helps you avoid unexpected delays caused by vehicle breakdowns, and helps maintain fuel efficiency. Fix small problems before they become big — and more expensive.



In addition to scheduling regular maintenance, you should:

- Ensure your tires are inflated according to the manufacturer's recommendations. For every 10 p.s.i. (69 kPa) underinflated, one per cent of fuel is wasted.
- Before you begin driving, it's the law to do a pre-trip inspection, and it can help you avoid breakdowns during your trip.
- Ensure all fluid levels such as motor oil and coolant are correct — underfilling or overfilling can damage your vehicle.
- Continually monitor your vehicle's condition during the trip:
 - Check the gauges on your instrument panel frequently. Conduct enroute inspections, including tires and cargo, at least every three hours.
 - Monitor the air filter restriction indicator for signs that the filter is becoming plugged or contaminated.
 - Check for air leaks. They affect the use and effectiveness of the vehicle's air brakes. They also make the air compressor keep running longer, and this reduces fuel efficiency.
- Do a post-trip inspection to spot problems that could delay you next time.

Choosing a fuel-efficient vehicle

Equipment and options can make a big difference in fuel consumption.

Consider some of these equipment options.

Choose the right truck

Choosing the right truck for the job and ordering it with the proper options and specifications can save on fuel and overall operating costs.

Using a truck designed for long-distance highway transportation for city transport costs more than using a truck designed and geared for city use.

If two trucks can each carry the same payload, purchasing the lighter one results in better fuel economy and reduced operating costs.

Look for aerodynamic features

At between 90 and 100 km/h, about 50 per cent of the fuel consumed is used to overcome air resistance. Aerodynamic design features have a significant effect on how much fuel is consumed, particularly at highway speeds.

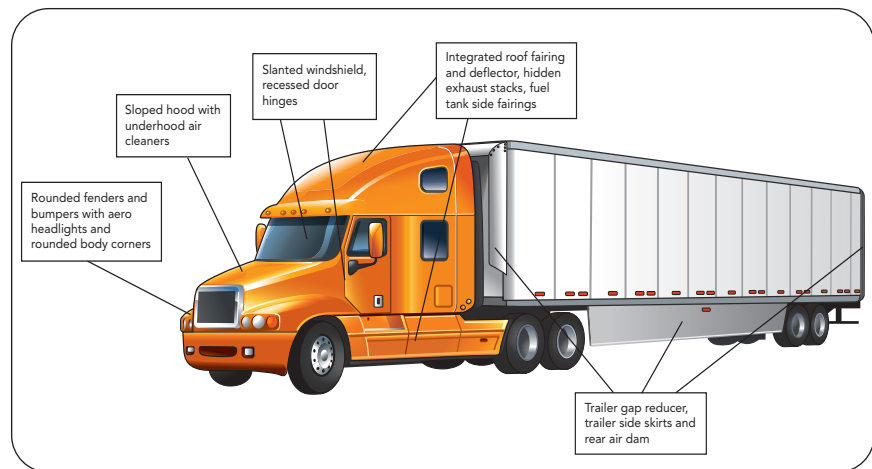

Streamlining features and accessories significantly improves fuel efficiency.

Some of the aerodynamic design features available on new trucks include:

- sloped hood with underhood air cleaners
- rounded bumpers
- rounded fenders with aero headlights and rounded body corners
- slanted and/or rounded windshield
- recessed door hinges and handles and low-profile side mirrors
- integrated roof fairings and deflectors, fuel tank side fairings
- hidden exhaust stacks
- trailer gap reducers.

Trailer aerodynamic features include side skirts and rear air dams. These aerodynamic features can improve fuel economy by 15 to 20 per cent. Many of these features can be added to older trucks and trailers.

fast fact

Aerodynamic drag is increased if any of the wheels on a tractor-trailer combination aren't properly aligned and tracking parallel to the direction of travel.

Aerodynamics should also be considered when loading flatbed trailers and flat deck trucks. Keeping the load low and covering it with a tarpaulin improve aerodynamics and help reduce fuel consumption.

Tire choice

Tires with a rib tread design are more fuel efficient than tires with a lug tread design on drive and steering axles.

Also consider super-single tires rather than dual tires on the drive axles. Super-single tires provide low rolling resistance, are lighter and lower vehicle height.



Ribbed tire tread design



Lugged tire tread



Super-single tire

Accessories

Choose and use accessories to improve productivity and fuel efficiency:

- Oil pan heaters and block heaters help with cold starting and ensure the engine oil circulates better when the engine is started.
- Fuel heaters prevent fuel gelling in cold weather.
- Thermostatically controlled engine fans, winter grille covers, battery blankets and in-cab auxiliary heaters conserve engine heat in cold weather.

On-board computers that can monitor fuel consumption are available for new trucks and may be added to older trucks. They can help you drive in the most fuel-efficient way.

Review questions

1. Approximately how much better fuel economy can you achieve by using good driving techniques?
2. What should you consider when planning a fuel-efficient route?
3. How long should you let a diesel engine idle when you first start it?
4. Is it a good idea to leave the engine running when you're not driving (such as when stopped at a truck stop)?
5. What are some smart driving techniques that can also save fuel?
6. Name some of the items that you should check as part of a pre-trip, enroute, or post-trip inspection that affect fuel efficiency.
7. What are some of the aerodynamic features of new trucks and trailers that improve fuel efficiency?

5

skills for driving trucks and trailers

This chapter is particularly useful for people working towards a Class 1 or Class 3 licence. You'll find information about driving with a trailer, loading, transporting dangerous goods and reporting to weigh scales.

What you'll learn

After studying this chapter you'll be able to:

- describe the safety considerations and basic techniques for driving with a trailer
- list the steps for coupling and uncoupling a tractor and trailer
- identify the various devices for securing loads and describe how to use them to safely secure a load
- describe how to safely handle special cargo such as livestock, liquid tank loads, etc.
- list the nine classes of dangerous goods; describe the legal responsibilities of transporting dangerous goods; and describe what to do in an emergency situation involving dangerous goods
- list the allowable vehicle and load dimensions and describe the requirements for oversized and overloaded vehicles
- describe the two different types of weigh scales and when a driver is required to report to a weigh scale.

Driving with a trailer

Manoeuvring a vehicle that has one or more trailers is a difficult skill to learn, but most Class 1 drivers do it every day.

Backing up

Backing up is always dangerous because you can't see everything behind your vehicle. For some general guidelines on backing up with or without a guide see **chapter 3, basic driving skills, backing up**.

A tractor with a semi-trailer has an articulation point (where it pivots). This makes backing up more complex.

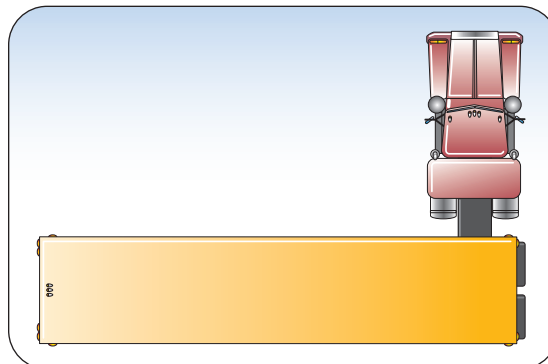

Backing up a single-unit vehicle is done in the same way as backing up a passenger vehicle. Backing up a tractor with a semi-trailer is different.

Turn your steering wheel to the direction that's opposite to where you want your trailer to go when you start backing up.

This S-shaped tracking pattern is the type of path a tractor-trailer unit creates when it backs up.

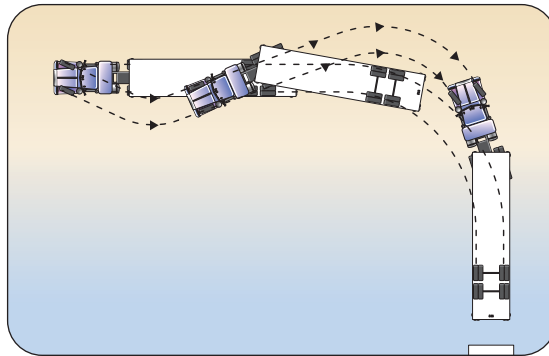

Then turn the steering wheel the other way as soon as your trailer begins to turn. At this point, you should be turning your steering wheel in the same direction as your trailer is travelling.

As your trailer begins to turn, your tractor must begin to follow a path

that matches the trailer's path. If it isn't you risk jackknifing your vehicle. A tractor-trailer combination backing into a normal right-angle turn would follow an S-shaped curve.

Towing trailers

Towing trailers requires more skill and practice than operating a single-unit truck. When you're towing, you must steer carefully. A sudden movement could cause your trailer to roll over and your tractor may follow, a major cause of death among truck drivers.

A loaded vehicle is more likely to roll over than an empty vehicle. Drive slowly around curves and make your turns gradually. Rollovers can happen when you turn too quickly.

You can help prevent rollovers by loading your cargo correctly. This is important on any type of vehicle. The higher your vehicle, the longer your trailer or the more trailers you're towing, the more important correct loading is.

Keep your cargo as close to the centre of your rig as possible so it doesn't cause your trailer to lean. It's also critical to spread out your cargo and keep it as close to the trailer deck as possible. As the height of a load increases, the midpoint of the weight (the centre of gravity) moves higher. A vehicle with a higher centre of gravity is more likely to rolling over.

Towing doubles

When towing two trailers, there's more chance of a trailer jackknife or trailer rollover, and the last trailer in a combination is the most likely to rollover. Here are some safety tips:

- Drive even more smoothly and consistently — accelerate smoothly, brake smoothly, and steer smoothly.
- Allow extra following distance and allow even more time when accelerating, passing or overtaking.
- Remember that a safe speed for a straight truck or a single trailer combination vehicle may be too fast when towing multiple trailers.
- Check your mirrors often so that you're aware of traffic behind you and traffic that may be passing you. Stay centred in your lane. There will be more offtrack when towing two trailers than with one trailer. Remember that in turns and curves, the extra length and extra articulation points mean you may encroach onto the lane beside you.

- Be careful when entering and exiting highways. Smoothly accelerate and steer onto highways, and make sure you have plenty of space to merge. When exiting, slow down well in advance. Deceleration lanes often are curved and some have a stop sign or traffic light at the end, so make sure you have slowed enough to drive through the curve and to safely stop at the end if necessary.
- Different trailer weights can affect the handling characteristics of the combination. Couple the more heavily loaded trailer to the tractor with the lighter trailer behind.
- Take care when coupling and uncoupling multiple trailers. If the trailers have spring brakes, make sure they're applied before coupling. If the trailer doesn't have spring brakes, make sure the trailer is blocked to hold it in position for coupling.
- Since it's difficult to back up with two trailers, you may first want to disconnect the rear trailer.
- Never unlock the pintle hook with the dolly still under the rear trailer. The dolly tow bar may fly up, possibly causing injury, and make it very difficult to re-couple.

Swerving and whipping

Whenever you tow a trailer, there's a danger that the trailer will begin to swerve or whip (that is, move quickly and independently of the tractor, back and forth across the roadway). This is extremely dangerous and must be dealt with immediately.

Whipping and swerving may be caused by:

- driving too fast for the conditions
- sudden steering changes
- improper trailer connections
- shifting loads
- dragging brakes
- a flat tire.

If your trailer whips or swerves, slow down and stop as soon as it's safe. A small problem can quickly turn into a serious hazard.

Some type of adjustment will be needed to fix whatever has caused your trailer to whip. You may need to fix a mechanical problem, adjust your load or change your driving. The only way to discover whether your trailer was swerving because of a serious mechanical problem is to stop and check your vehicle. Even if the swerving stops when you slow down, it's still important to stop and check your vehicle and load. The whipping and swerving may have shifted your cargo or loosened a trailer connection.

fast fact

Brakes must be properly adjusted for the spring brakes to remain applied and effective.

Parking

Block the wheels of a parked trailer so it can't roll.

The air pressure in the trailer air tank will bleed down over time when the trailer is parked. How fast it bleeds down will depend on how much the trailer system leaks. If the trailer is not equipped with spring brakes and the trailer air tank(s) drains, the trailer brakes will release as air pressure drops. If the trailer is equipped with spring brakes and the trailer air tank(s) drains, the trailer brakes will remain in the applied position.

Preparing to tow

Almost all Class 1 drivers, and many drivers with a different class of licence, will need to become experts on coupling and uncoupling a tractor and trailer. It's critical that any trailer you tow is securely fastened to your towing vehicle.

Coupling and uncoupling

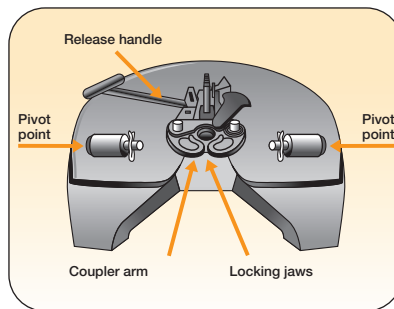

Most coupling is done with a fifth wheel or pintle hitch. This section gives you information about parking trailers and coupling and uncoupling units.

Coupling with a fifth wheel

Always use great care when coupling a tractor and trailer, or it can put your safety, as well as the safety of your load and others on the road, at risk.

Parts of a fifth wheel.

To couple a tractor and trailer using a fifth wheel follow these steps:

1. Inspect fifth wheel

Set tractor parking brakes.

Exit cab.

Check the following:

Fifth wheel

- inspect for damage, lubrication, security
- if the fifth wheel slides, check that it's locked in place to the tractor frame
- make sure that the fifth wheel is tilted downward toward the rear of the tractor, and that the coupler jaws are open

Air lines

- ensure air lines and electrical cable are supported and routed so that they don't get in the way when backing under the trailer

fast fact

Some trailers don't have spring brakes. With these, connect the lines and charge the trailer system. Then apply the trailer brakes before connecting to the trailer.

2. Inspect the trailer

Block the trailer wheels.

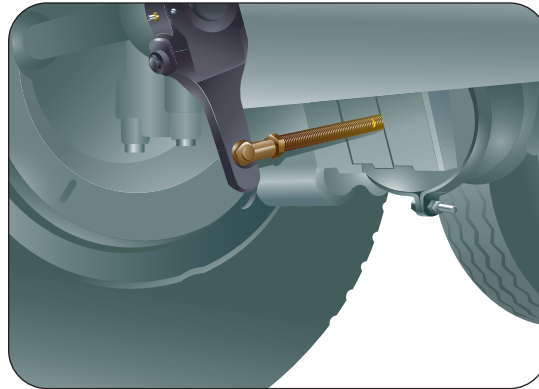

Make sure the trailer brakes are applied before coupling to the trailer.

driving tip

Check the location of the trailer kingpin — if it's too far back from the front of the trailer, the rear of the tractor cab or tractor frame may strike the trailer while coupling.

To prevent this, adjust the location of the fifth wheel.

Trailer

- if the trailer is equipped with spring brakes, make sure they have applied
- check that any cargo is secure
- check trailer kingpin and trailer apron
- ensure that the kingpin isn't bent or broken and that the apron is flat
- check the location of the trailer kingpin — if it's set far back from the front of the trailer, the fifth wheel may need to be repositioned to allow turning clearance between the front of the trailer and rear of the tractor

Area around trailer

- ensure the area's clear

3. Position the tractor

Re-enter tractor.

Release tractor brakes.

Drive the tractor to a position directly in front of and in line with the trailer.

Tractor position

- make sure the tractor is in line with the trailer
- fifth wheel should be in line with trailer kingpin
- check your position using outside mirrors — if the tractor and trailer are lined up, you should be able to see an equal portion of each side of the trailer in each mirror

Make sure you're aligned with the trailer before coupling to it.

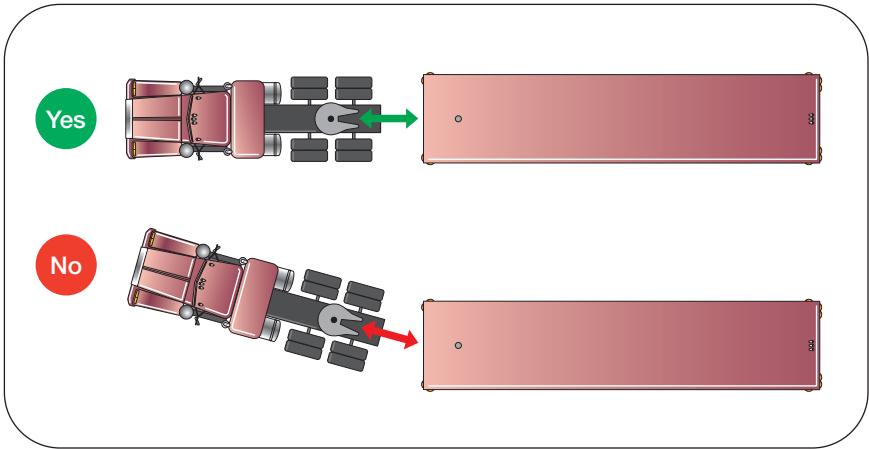

4. Back up to the trailer

Turn on four-way flashers and sound horn.

Back up slowly toward the trailer to a position directly in front of and in line with the trailer.

Tractor position

- stop when the fifth wheel just touches the trailer apron — don't back up too far
- make sure you're backing in a straight line, not at an angle (if you're on an angle, this could push the trailer sideways and damage the landing gear)

When you're backing up, stop when the fifth wheel touches the trailer apron.

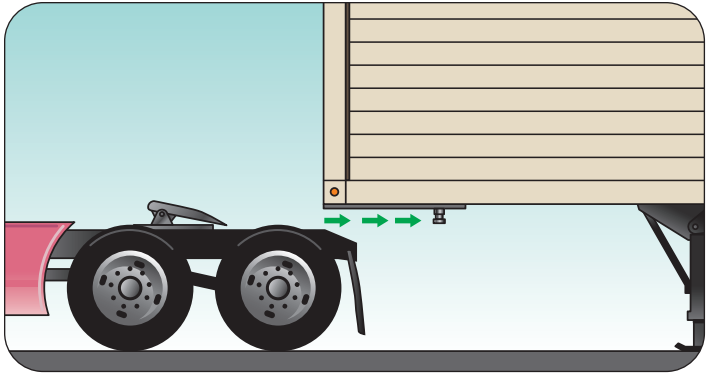

driving tip

If you need to adjust the trailer height:

- adjust the trailer height by cranking the landing gear up or down, or
- raise or lower the air suspension.

5. Check height and alignment

Set the tractor parking brakes and exit the cab.

Tractor and trailer alignment

- the centre of the trailer apron should line up with the centre of the fifth wheel
- the trailer apron should be touching the fifth wheel directly above the fifth wheel pivot points — if it's touching behind or ahead of the pivot point, the trailer height needs to be adjusted

driving tip

If the trailer doesn't have spring brakes, before backing under the trailer:

- connect the air lines to the trailer
- charge the trailer
- apply the trailer brakes.

driving tip

Use the differential lockup for additional traction if it is slippery.

driving tip

Use a flashlight to check that the locking jaws on the fifth wheel are securely closed around the trailer kingpin.

Also remove the keys from the ignition so that nobody tries to move the tractor while you are underneath the trailer.

6. Connect to the trailer

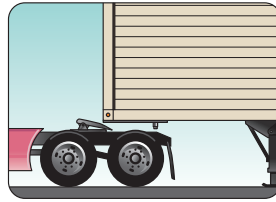

Good

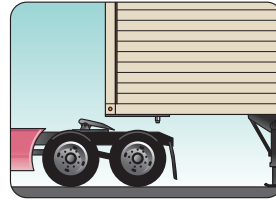

Too high

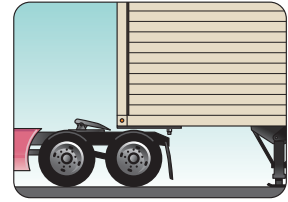

Too low

Re-enter cab.

Turn on four-way flashers and sound horn.

Slowly back the rest of the way to connect the fifth wheel to the trailer kingpin.

Trailer connection

- use the lowest reverse gear to back up very slowly
- stop when you feel or hear the trailer kingpin lock into the fifth wheel jaws

7. Secure the trailer

Set the tractor parking brakes and exit cab.

Connect the air lines and electrical cable to the trailer.

Re-enter cab.

Turn on lights.

Shut off engine.

Exit cab.

Go under the trailer to check the connection.

Trailer connection check

- fifth wheel jaws have engaged the kingpin
- no space or daylight between the fifth wheel and the trailer apron
- fifth wheel release handle is in the locked position

Trailer lights

- check that trailer electrical connection is secure by checking trailer lights including tail lights, brake lights, licence plate light and clearance lights

Air brake leakage

- listen for any air leaks from air brake system

8. Tug test the connection

Raise landing gear until the legs are slightly off the ground (don't raise the landing gear all the way).

Re-enter cab.

Release the tractor brakes (the trailer brakes should still be applied).

Gently tug against the trailer parking brakes to check the connection.

Trailer connection

- trailer kingpin should be securely held by fifth wheel jaws
- the trailer brakes should prevent the trailer from moving when trying to move the tractor forward
- re-charge the air suspension if it's been lowered
- check for air leakage in the air brake system

fast fact

A trip inspection report is required for every new trailer you pick up each day.

driving tip

If the rear of the tractor is too close to the trailer landing gear and the tractor has a sliding fifth wheel, reposition the fifth wheel to provide clearance.

9. Prepare to pull away

Set the parking brakes.

Exit cab.

Raise landing gear completely and ensure crank handle is locked in gear and secured.

Remove and store the wheel blocks.

Trailer turning clearance check

- clearance between the rear of the tractor and trailer landing gear
- clearance between the rear of the tractor cab and front of the trailer (for example, clearance between trailer refrigerator unit and rear of tractor cab, or between front of trailer load and rear of tractor cab)
- air lines and electrical cable are properly supported and routed so that they don't get in the way when turning

10. Pull away

Re-enter cab.

Release parking brakes.

Slowly pull away, checking that trailer connection is secure.

At slow speed, apply the trailer hand valve to check trailer service brake operation.

When you turn, the fifth wheel acts as a pivot point. Check to make sure there's clearance between the tractor and trailer for turning.

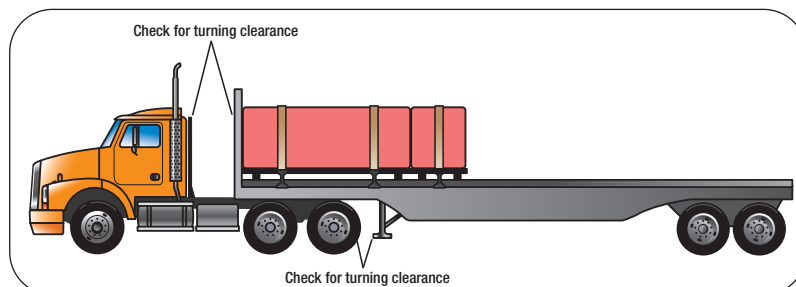

Uncoupling units

Use these steps to uncouple a tractor and trailer joined with a fifth wheel:

1. Position the tractor and trailer

Move forward/backward so that the tractor is directly in line with the trailer (not at an angle).

Tractor and trailer position

- if you're lined up, you should be able to see both sides of the trailer in the exterior mirrors
- ensure the road or ground surface is level and will support the trailer

Yes



No



Make sure that the tractor and trailer are lined up before uncoupling.

driving tip

The tractor may only move a few centimetres, but this will ease pressure on the fifth wheel locking jaws.

2. Ease pressure on the fifth wheel locking jaws

Set the trailer brakes and release tractor brakes.

Back up gently and apply tractor parking brakes while the tractor is pushing against the trailer.

Fifth wheel locking jaws

- back up the tractor to relieve pressure of the fifth wheel locking jaws on the trailer kingpin

fast fact

Both landing gear supports must touch the ground to support a trailer.

3. Prepare to uncouple

Exit cab.

Block trailer wheels.

Place blocks or pads under the trailer landing gear if needed.

Lower the trailer landing gear until both supports touch the ground and pressure is released off the fifth wheel.

Disconnect air lines and electrical cable and secure lines to tractor.

Pull the fifth wheel release handle to unlock the fifth wheel jaws.

fast fact

Weather conditions can affect surfaces where you may want to park your trailer. Rain or snow can make gravel, sand or dirt soft. Hot weather may make asphalt roads and parking lots soft. Place blocks or pads under the landing gear to distribute the trailer's weight and prevent the landing gear from sinking into the ground.

driving tip

For trailers equipped with air suspension, the air suspension should be drained before applying the trailer brakes when leaving the trailer parked.

fast fact

To avoid injury while uncoupling a trailer, keep clear of the tractor wheels. The wheels of the tractor may roll slightly when the jaws of the fifth wheel are opened.

Trailer landing gear

- make sure the trailer is level when the landing gear is extended
- ensure the road or ground surface is level and will support the trailer

Tractor

- ensure air lines and electrical cable are secured to the tractor
- check that fifth wheel release handle is in the unlocked position

4. Move the tractor slightly forward

Re-enter cab.

Release tractor parking brakes.

Move the tractor forward slowly, stopping when the fifth wheel begins to clear the trailer apron.

Trailer security

- check that the trailer landing gear is supporting the trailer as you move the tractor forward

5. Prepare to fully uncouple

Set tractor parking brakes.

Exit the cab.

Trailer security

- check that the trailer landing gear has been lowered far enough to support the trailer once the tractor is moved completely away from the trailer
- check that the ground is firm enough to support the trailer
- if the trailer has air suspension, make sure the suspension air supply has been drained

6. Pull away

Re-enter cab.

Release tractor parking brakes.

Charge tractor air suspension if it has been lowered.

Move the tractor ahead slowly so that it's completely clear of the trailer.

Trailer security

- check in the mirrors to ensure that the trailer landing gear is supporting the trailer

Other types of connections

A pintle hitch connection uses a hook on the vehicle in front and an eye on the vehicle behind. Some pintle hitch connections have an air or hydraulic ram to take up any slack between the hook and the eye.

When you use any coupling device (other than a fifth wheel) you must also use chains or metal cables to connect the towed and towing vehicles. These auxiliary chains or cables must be equal to the strength of the coupling device.

Attach the pintle eye on the trailer behind to the pintle hook on the vehicle in front. Use the safety catch to secure the pintle hitch connection, along with safety chains and/or cables.

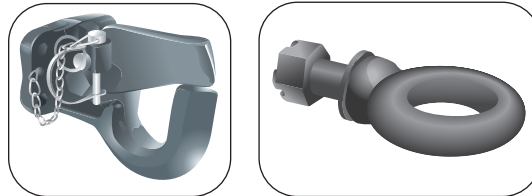

The drawbar or other connection between the motor vehicle and the trailer may not be more than five metres long unless you're towing a pole trailer.

When a driver is towing more than one trailer, sometimes a converter dolly is used.

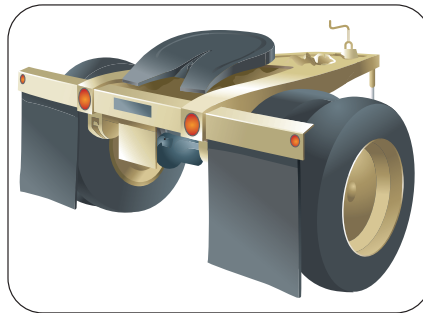

A converter dolly.

driving tip

When towing with a converter dolly, make sure that the air brake lines from the truck to the converter dolly and from the converter dolly to the trailer are properly connected so that the brakes on the trailer will function.

A converter dolly has an axle, a fifth wheel and a hitch. Other devices may also be used to couple and spread the weight of large loads.

Coupling devices must be strong enough to hold the vehicles together when they're loaded and must be fastened to a structurally adequate part of the frame of each vehicle.

Coupling with a pintle hitch

Use these steps to couple a truck and trailer joined with a pintle hitch:

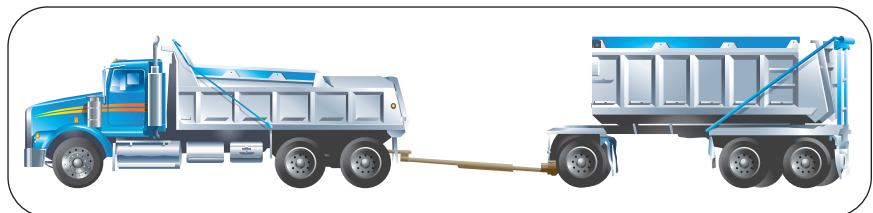

A pintle hitch is used to connect this dump truck to the dump trailer.

driving tip

Apply the trailer brakes before coupling to the trailer.

fast fact

Some trailers don't have spring brakes. With these, connect the lines and charge the trailer system and then apply the trailer brakes before connecting to the trailer.

driving tip

You need to be very accurate in placing the pintle hook relative to the trailer pintle eye.

Place a block of wood or other marker beside one of your truck tires that's visible in your mirrors to help you see how accurately you've positioned the pintle hook.

1. Inspect pintle hitch and trailer

Set truck parking brakes.

Exit cab.

Check the following:

<input type="checkbox"/> Pintle hook	<ul style="list-style-type: none">• check pintle hook and latch for cracks and wear
<input type="checkbox"/> Trailer	<ul style="list-style-type: none">• if the trailer is equipped with spring brakes, make sure they have applied• block trailer wheels• check that any cargo is secure• check pintle eye for cracks or excessive wear
<input type="checkbox"/> Area around trailer	<ul style="list-style-type: none">• ensure the area is clear

2. Position the truck

Re-enter the truck.

Release truck brakes.

Move truck to a position directly in front of and in line with the trailer.

<input type="checkbox"/> Truck position	<ul style="list-style-type: none">• make sure the truck is in line with the trailer• check your position using outside mirrors — if the truck and trailer are lined up, you should be able to see an equal portion of each side of the trailer in each mirror
--	--

3. Back up to the trailer

Turn on four-way flashers and sound horn.

Back up slowly toward the trailer and stop just before the pintle hook on the truck touches the trailer pintle eye.

<input type="checkbox"/> Truck position	<ul style="list-style-type: none">• stop just before the pintle hook on the truck touches the pintle eye on the trailer• make sure you're backing in a straight line (if you're on an angle, it's more difficult to position the truck to hook up to the trailer)
--	--

4. Check height and alignment

Set the truck parking brakes.

Exit cab.

Check the following:

Truck and trailer alignment

- the truck pintle hook should line up with the trailer pintle eye
- adjust the drawbar height if needed so that the pintle eye is just slightly higher than the pintle hook

5. Prepare to connect to the trailer

Re-enter cab.

Release truck parking brakes.

Sound your horn before backing.

Slowly back up to a position where the pintle eye can be lowered onto the pintle hook.

driving tip

If the trailer doesn't have spring brakes, before connecting to the trailer:

- connect the air lines to the trailer
- charge the trailer air system
- apply the trailer brakes.

Trailer connection

- back up to the trailer so that the pintle eye is directly over the pintle hook

6. Connect to the trailer

Set truck parking brakes.

Turn on lights.

Exit cab.

Lower the pintle eye onto the pintle hook.

Close the pintle hook safety latch.

Attach the safety cables and/or chains between the truck and trailer.

Raise the drawbar support leg (if equipped).

Connect the air lines, electrical cable and hydraulic lines (if equipped) between the truck and trailer.

Remove and store the wheel blocks.

Check the following:

fast fact

A trip inspection report is required for every new trailer you pick up each day.

Trailer connection check

- pintle eye is secured in pintle hook
- safety latch is locked
- safety cables and/or chains are in place and securely fastened
- drawbar support leg (if equipped) is retracted and secured
- air lines, electrical cable and hydraulic lines (if equipped) are securely connected

Trailer lights

- check that the trailer electrical connection is secure by checking trailer lights including tail lights, brake lights, licence plate light and clearance lights

Trailer turning clearance check

- clearance between rear of truck and front of trailer

driving tip

If the trailer brakes don't release when you charge the trailer braking system, the air lines may be crossed.

7. Prepare to pull away

Re-enter cab.

Charge the trailer braking system.

Raise trailer air suspension if it has been lowered.

Pressurize the air or hydraulic (no slack) ram (if equipped).

Air brake leakage

- check for air leakage in the air brake system

8. Pull away

Release parking brakes.

Slowly pull away.

At slow speed, apply the trailer hand valve to check trailer service brake operation and that trailer connection is secure.

Trailer connection

- pintle eye should be securely held in pintle hook

Uncoupling pintle hitch units

Use these steps to uncouple a truck and trailer joined with a pintle hitch:

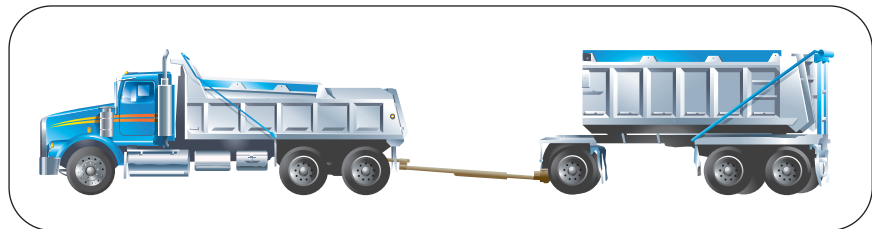

1. Position the truck and trailer

Move forward/backward so that the truck is directly in line with the trailer (not at an angle).

Check your position using the exterior mirrors.

Truck and trailer position

- if you're lined up, you should be able to see both sides of the trailer in the exterior mirrors
- ensure the road or ground surface is level and will support the trailer

driving tip

Place a block of wood or other marker beside one of your truck tires that's visible in your mirrors to help show how close your truck is to the trailer when you return later to re-couple.

driving tip

Fasten disconnected air lines and other lines to dead-end (dummy) connectors to prevent dirt and debris from entering the lines and to prevent the lines, from chafing against other components or bouncing off the vehicle.

2. Uncouple the pintle hitch

Set the truck and trailer brakes.

Release pressure from the air or hydraulic (no slack) ram (if equipped).

Exit the cab.

Block trailer wheels.

Disconnect the air lines, electrical cable, and hydraulic lines (if equipped) between the truck and trailer.

Disconnect the safety cables or chains and/or safety pin.

Release the pintle hook safety latch.

Lower the drawbar landing leg (if equipped).

Raise the drawbar so that pintle eye clears the pintle hook.

❑ Trailer uncoupling

- make sure the trailer is level
- block trailer wheels
- support the trailer drawbar after uncoupling if needed
- secure the air lines, electrical cable and hydraulic lines after disconnecting them

3. Pull away from trailer

Re-enter cab.

Release truck parking brakes.

Move the truck ahead slowly so that it's completely clear of the trailer.

❑ Trailer security

- check in the mirrors to ensure that the pintle connection is disconnected and that the trailer is secure

Loading

The way your load is arranged will be affected by your type of vehicle and by the weight, height, width, length and nature of your cargo. You need to learn the types of loads different vehicles can carry and what to do when a load is oversize. You'll likely load and secure different kinds of cargo during your career as a commercial driver.

Loading cargo



Securing a load and ensuring that it doesn't move during transport can be difficult. You may transport a wide variety of cargo types at different times, including livestock, explosives and intermodal cargo containers. Loading and securing your cargo incorrectly could cause death, injury or property damage. You may also face fines and penalties.







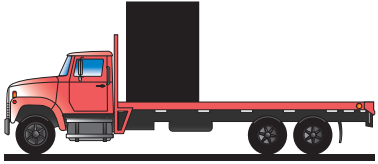

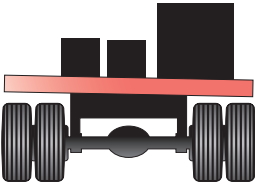
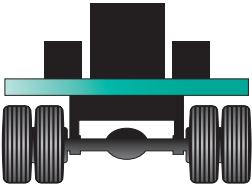
Arranging and distributing loads

The way you distribute your cargo's weight will affect the handling characteristics of your vehicle. It also affects the life of your vehicle's tires, frame, springs, axles and bearings.

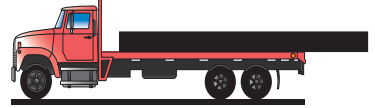
A poorly distributed load can overload an axle or set of tires, put unnecessary stress on your vehicle's frame and cause permanent damage and steering misalignment.

These illustrations show correct (right side) and incorrect (left side) ways to load your vehicle.

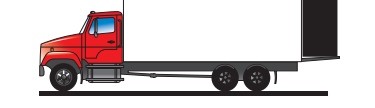
Wrong	Right
 <p data-bbox="564 831 938 1104">Don't place a very concentrated heavy load against the cab. This type of loading may permanently bend the frame. It'll also overload the front tires, which may make steering difficult and could cause a worn tire to blow out. This type of loading may also make your load dangerously top heavy.</p>	 <p data-bbox="976 831 1380 1104">Place a very concentrated heavy load near the rear, on its long side if possible. Most of the load should be partially over or just ahead of the rear axles to get proper tire loading. Make sure the load is securely blocked to prevent it from sliding forward. (More about this later in the chapter.)</p>
 <p data-bbox="564 1348 938 1621">Don't place a very heavy load on one side. This overloads the spring and the tires on the cargo side. The brakes may lock the wheels of the under-loaded side and could cause the tires to skid on wet surfaces. Loading in this unbalanced way may also cause flat spots on the tires.</p>	 <p data-bbox="976 1348 1353 1537">Load your vehicle so that an equal amount of weight is placed on all rear tires. This will eliminate twisting and stress on the frame. It also prevents overloading the axle housing and wheel bearing.</p>

Wrong	Right
 <p>Never load your vehicle this way. It may cause the frame to bend, will overload the rear tires and takes enough weight off the front tires to make steering almost impossible.</p>	 <p>The correct place for the concentrated load is partially over or just ahead of the rear axles with the longest side on the floor. Make sure the load is securely blocked to prevent it from sliding forward. (More about this later in the chapter.)</p>
 <p>On a rough road, a vehicle loaded this way may pivot on its rear wheels, taking the front wheels entirely off the road.</p>	 <p>A tractor trailer combination is the correct vehicle to use for this type of service because a longer, heavy vehicle is needed to carry this long load. Always use the correct vehicle for the job. The risk of damage to the truck and tires, and even serious collisions, may be reduced.</p>
 <p>This shows a heavy load with too much weight on the trailer's rear tires. The fifth wheel isn't supporting the load. The tractor's rear tires are likely to slip and wear away rubber. This vehicle will also be difficult to stop because the braking distribution will be uneven.</p>	 <p>The load should be centred to properly distribute its weight over the tires. The average semi-trailer type truck has a central weight distribution point at approximately the middle of the trailer. Make sure the load is securely blocked to prevent it from sliding forward. (More about this later in the chapter.)</p>
 <p>Never load items on the tailgate. It puts a severe strain on the equipment and can cause serious collisions.</p>	 <p>This load should be placed partially over or just ahead of the rear axles with its longest side on the floor. Make sure the load is securely blocked to prevent it from sliding forward. (More about this later in the chapter.)</p>

For safety reasons, always ensure you load your vehicle correctly.

The best way to distribute the weight of your cargo depends on the nature of the load and your vehicle configuration. Spread a concentrated heavy load evenly over as many axles as possible. Some trucks, like five-ton freight trucks, are designed to have approximately 90 per cent of the weight of their cargo on their rear axle(s) and 10 per cent on the steering axle. Others, like cement mixers and dump trucks, are designed to have approximately 70 per cent of the weight of their cargo on their rear axles, and 30 per cent on the steering axle(s).

Place the cargo midway between the rear axle unit and the drive axle unit when loading a trailer. This distributes the weight equally between the rear axle unit and the drive axle unit.

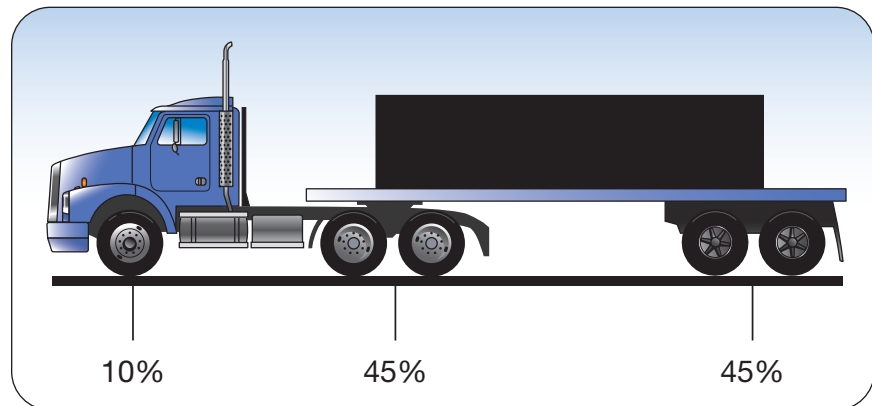

A tridem drive truck or truck tractor is required to have a combined steering axle weight, when loaded, of at least 25 per cent of the tridem axle weight — 40 per cent in the case of twin steering axles.

Trailers are designed to handle loads that are distributed evenly. They should have approximately 45 per cent of the weight of their cargo on the trailer axle unit, 45 per cent on the drive axle unit and 10 per cent of the weight on the steering axle.

fast fact

Cargo Security — Book 2, contains information on loading various special cargoes. It's available at provincial weigh scales and at www.th.gov.bc.ca/cvse.

You can find the North American Standard on cargo securement on the Commercial Vehicle Safety Enforcement website at www.th.gov.bc.ca/cvse or at www.ccmta.ca/english.

Securing cargo

Don't operate a vehicle unless its cargo is secured properly. Division 35 of the *Motor Vehicle Act Regulations (MVAR)* specifies requirements for transporting logs or poles, covers for loose loads, affixing and marking the front end structures and carrying luggage in buses.

B.C. has adopted the North American Standard on cargo securement. The Standard specifies requirements that apply to all types of cargo and includes specific requirements for certain commodities. Unless it's specified otherwise in the Standard, the general and specific requirements both apply.

Division 35 and the Standard apply to all vehicles carrying cargo on highways, regardless of the vehicle's gross vehicle weight.

You'll need to know the securement requirements for the types of cargo you're carrying. You can get copies of both the Standard and Division 35 through the Commercial Vehicle Safety and Enforcement Division website at www.th.gov.bc.ca/cvse.

General cargo securement requirements

The cargo securement system must be appropriate for the cargo's size, shape, strength and characteristics.

The securement system may include these components:

- vehicle structure
- blocking and bracing equipment
- securing devices, like tiedowns.

The securement system must be able to withstand these forces:

- 0.8g deceleration in a forward direction
- 0.5g deceleration in a rearward direction
- 0.5g acceleration in either sideways direction, and
- downward force equal to at least 20 per cent of the weight of the cargo.

The load on each component of the securement system must not exceed the working load limit of the component.

Cargo securement system components must be in good working order — not damaged, cracked, cut or weakened — and fit for the purpose for which they're used.

General requirements for tiedowns

Tiedowns must be designed, constructed and maintained so that a driver can tighten them (except for steel strapping). Tiedowns must be taut and not slip, loosen, unfasten, open or release while a vehicle's in operation.

Use edge protectors where a tiedown could be cut or scraped where it contacts cargo. Tiedowns should be located inboard of rub rails if possible.

One long chain could be used as two tiedowns, if each tiedown has an independent tensioning device so that failing doesn't cause the other to fail.

Tiedowns must not be used for cargo securement if:

- the chain has cracked welds or links
- the chain has bent, twisted, stretched or collapsed links
- chain links are weakened by gouges, nicks or pits
- the chain is incorrectly repaired
- chain links are obviously worn or showing other evidence of loss of strength
- there are knots in any portion of chain, wire rope or webbing
- there are spread or disturbed grab hooks
- nylon webbing has cuts, nicks or splits
- wire cable has missing strands or wraps
- an anchor point is weakened or shows loss of strength due to cracks, breaks or distortion.

Number of tiedowns

The following table shows the minimum number of tiedowns required if an article of cargo on or in a vehicle isn't prevented from moving forward by a front end structure, a tiedown, other cargo or a device like a drop on a step deck trailer.

fast fact

Consider the length of the cargo first and its weight when deciding how many tiedowns to use.

As a rough guide, use two tiedowns for the first 3.04 m of a load and one tiedown for every 3.04 m after that. Machinery or fabricated structural items that need special securement because of their size, design, shape or weight are exempted from these requirements.

Article description	Minimum number of tiedowns
1.52 m or shorter and 500 kg or lighter	1
1.52 m or shorter and over 500 kg	2
More than 1.52 m but 3.04 m or less	2
Longer than 3.04 m	2 + 1 tiedown for every additional 3.04 m or part of that thereof

When cargo is prevented from moving forward, the minimum number of tiedowns required is one tiedown for every 3.04 m of length.

This article is 1.21 m long and weighs 600 kg. The article isn't prevented from moving forward. Use two tiedowns equally spaced.

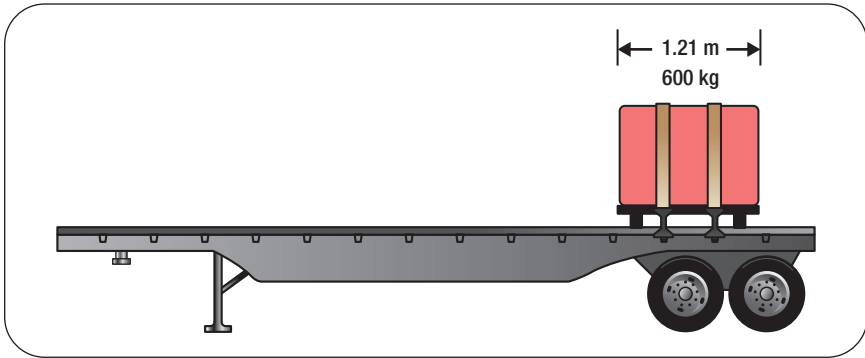

Here, two articles are arranged on a flat deck. Since the first article is butted against a bulkhead, use only two tiedowns. Since the second article is butted against the first article, use only one tiedown.

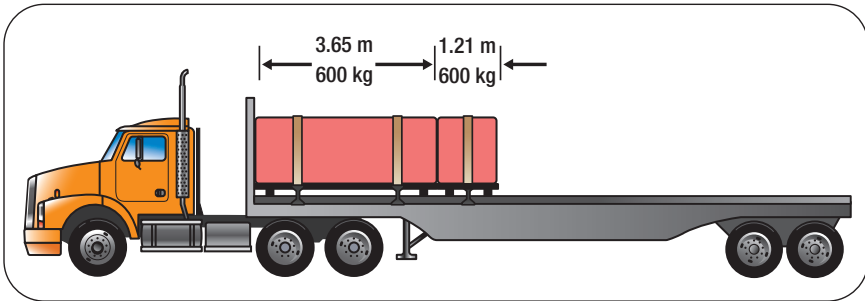

This article is 3.65 m long and weighs 600 kg. Since the article isn't prevented from moving forward, use three tiedowns equally spaced.

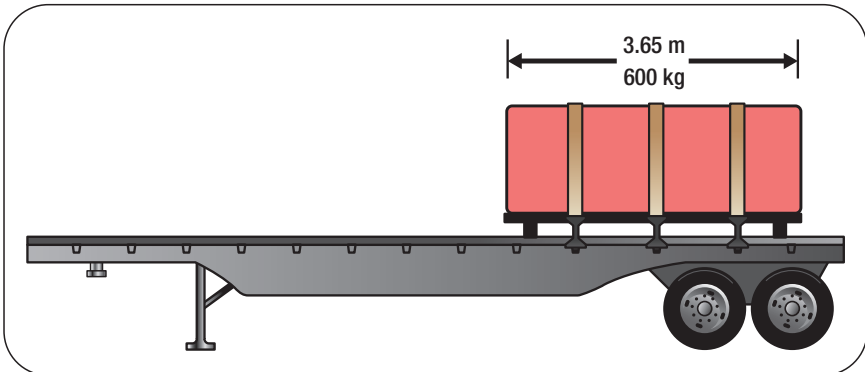

Strength of tiedowns

The working load limit of tiedowns used to secure cargo must be at least 50 per cent of the cargo weight. The Standard provides the working load limit default of the tiedown.

The diagrams on the previous page show articles 3.65 m in length weighing 600 kg. In these examples, the aggregate working load limit of the tiedowns must be no less than 300 kg (50 per cent of 600 kg). For an article 3.65 m long that's not prevented from moving forward, use three tiedowns. So each tiedown must have a working load limit of not less than 100 kg ($300 \text{ kg} \div 3$).

If the only available tiedowns have a working load limit of 50 kg, use six tiedowns.

But, if tiedowns rated at a working load limit of 200 kg were available, use three tiedowns, since the Standard gives a minimum number required as well as the minimum strength.

Determining working load limit

You can find the working load limit marked on the component by the manufacturer. (The Standard prohibits the use of unmarked tiedowns as of January 1, 2010.)

Standard 10 provides the default working load limits for chain, synthetic webbing, wire rope (6 x 37, fiber core), manila rope, synthetic fiber rope and steel strapping, as well as numerous manufacturing standards.

Chain connector links

The chain connector link you use when securing your load must be compatible with the grade of chain you're using. It's a cliché, but it's true that a chain's only as good as its weakest link. That weakest link could be a connector, an eyelet, or any other part of the chain assembly.

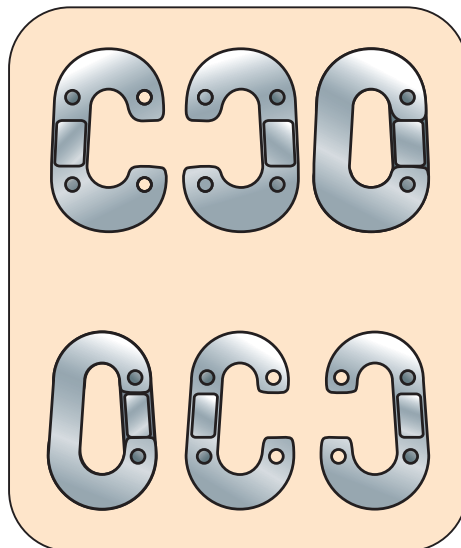

Pear-shaped missing links and double clevis links.

An alloy connecting link (left) and quick connector (right). Quick connectors are not suitable for any heavy duty operation.

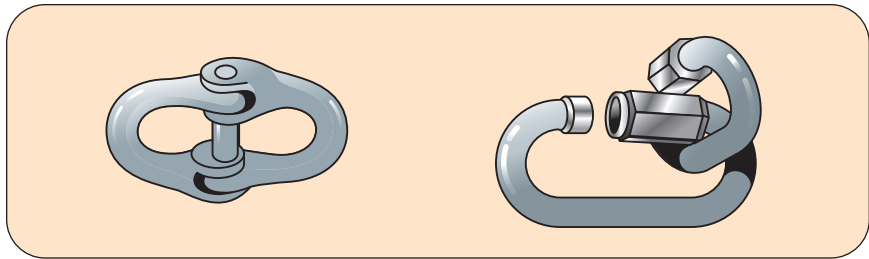

A chain hook on the left and a slip hook on the right.

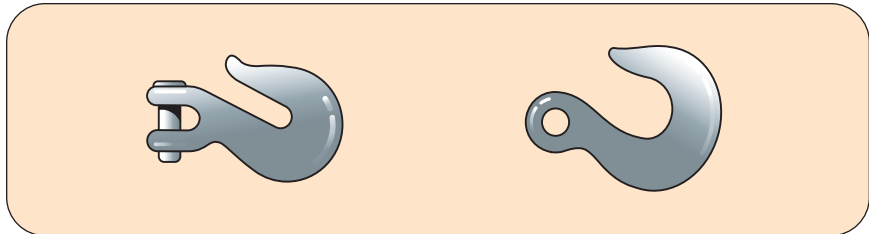

fast fact

Cargo Security — Book 2, contains information on loading special cargoes. *Book 2* is available at provincial weigh scales and at www.th.gov.bc.ca/cvse.

fast fact

If a winch-type tightening device is used to secure a wire rope, it should be specifically designed for use with wire cable. If a winch designed for webbing is used, protect the wire rope by anchoring it securely to the drum.

Standard load binders are used to tighten (bind) the chain, webbing and other strapping used to secure the load so it won't shift.

When you use load binders, you must:

- Make sure your tiedown assemblies are strong enough. Always assume your tiedown assemblies, including the clevis hooks and load binders, are the lowest grade for their size unless they have a clear marking or a permanently attached tag that states something different.
- Protect all tiedown assemblies from abrasion.
- Don't use any tiedown assembly that's worn beyond a wear limitation embossed by the manufacturer or is unsafe.
- Lock every load binder handle in place to prevent the handle from unlocking. Use rope, wire, chain or a locking mechanism. Using the free end of the chain is adequate.
- Ensure you can tighten all tiedowns unless steel, fiber or synthetic strapping is used. In these cases ensure the strapping is taut.

The information on securement systems and working load limits is detailed in Standard 10. Other requirements:

- A friction mat which isn't marked by the manufacturer with a working load limit is assumed to provide resistance to horizontal movement equal to 50 per cent of the weight of the cargo resting on the mat.

A winch.

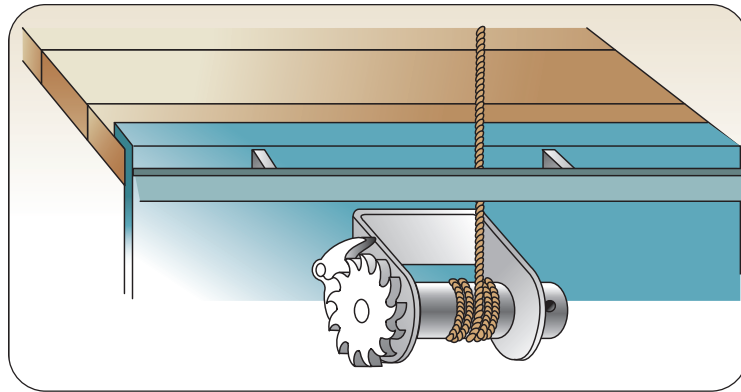

Nylon webbing with a winch.

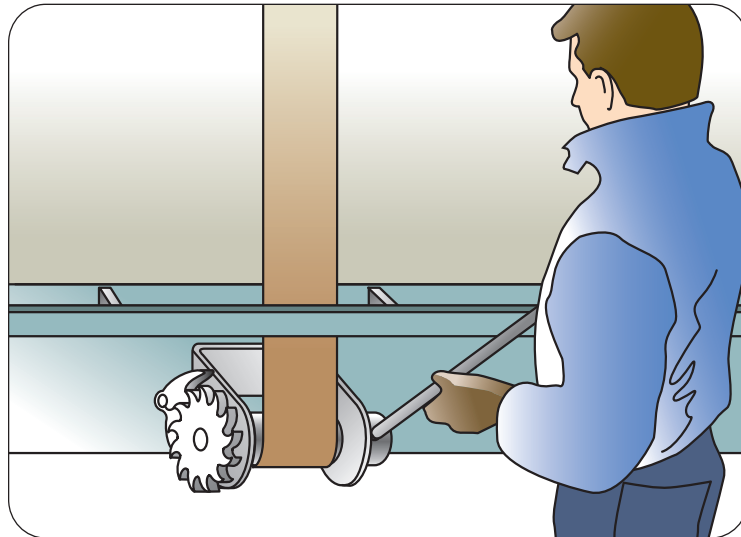

Webbing with a hook end.

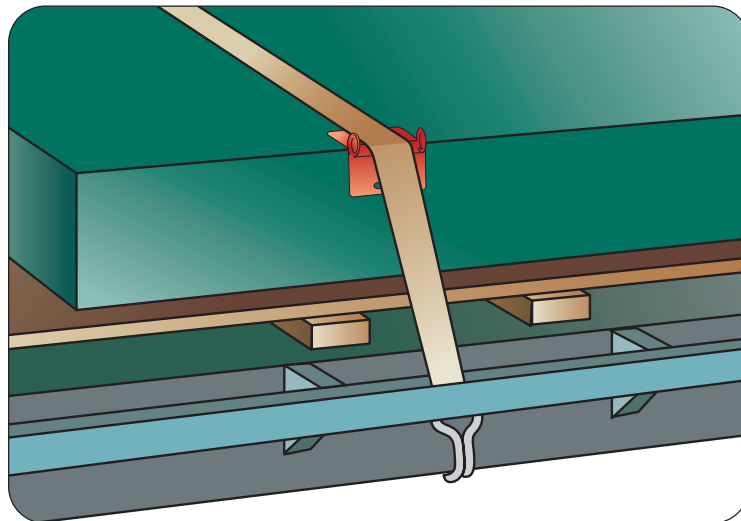

Two types of webbing protectors.

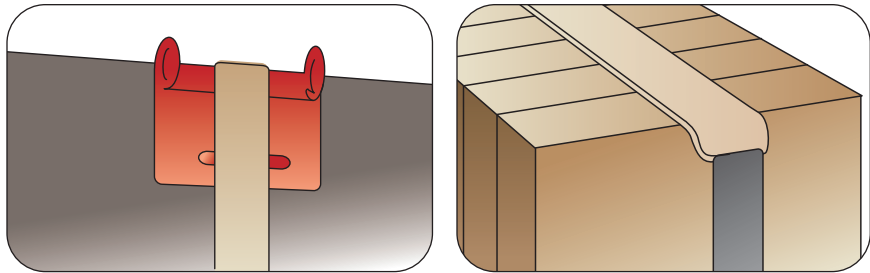

fast fact

Rub rails must not be used as anchor points.

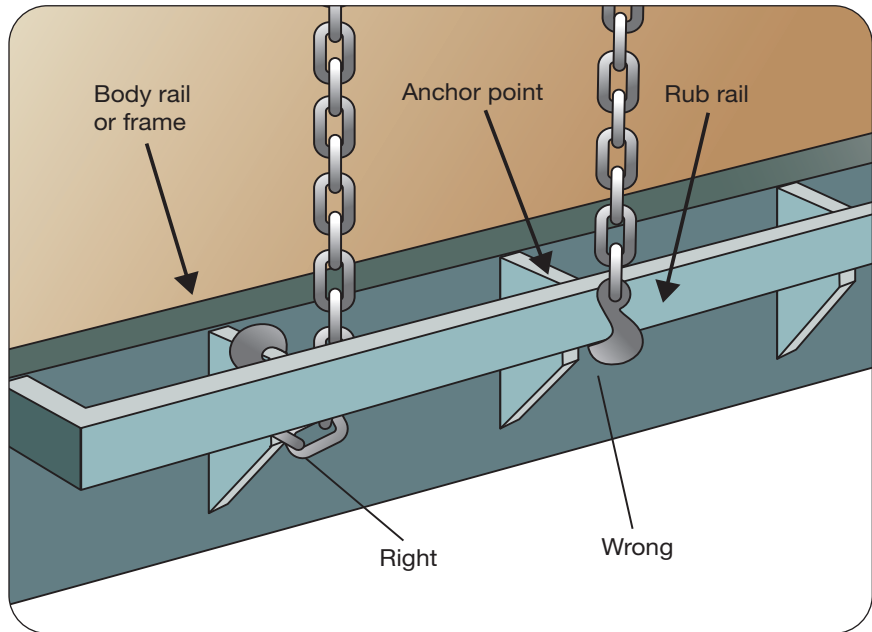

definition

Dunnage is spacing blocks, boards and mats that separate cargo from itself and its restraints.

- Timber used on or within a vehicle as dunnage, chocks or cradles for blocking or bracing shall be strong enough that it will not be split or crushed by the cargo or the tiedowns.

Dunnage in the form of corner boards is used with tiedowns to secure this load of bricks.

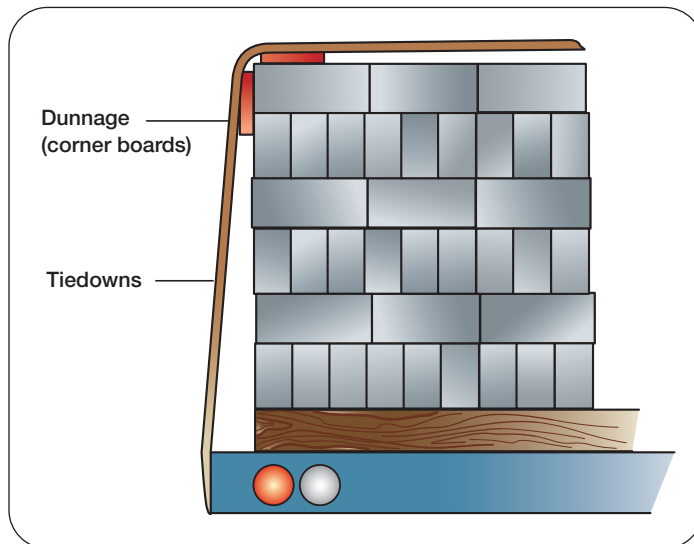

- Where the articles of cargo on or within a vehicle are placed beside each other and secured by tiedowns that pass over two or more articles, the articles shall be:
 - d) placed in direct contact with each other, or
 - e) prevented from moving towards each other while the vehicle is on a highway.
- Where any cargo or portion thereof may roll, it shall be restrained by chocks, wedges, a cradle or another securing device that prevents the cargo from rolling.

For bagged products such as cement, fertilizer or other products packaged in bags and then stacked on pallets for shipment, interlocking the bags on the pallets and wedging the pallets on the trailer isn't enough. Secure the bags by tiedowns and dunnage (corner boards).

If a load is supported on rollers, then lock at least one roller to prevent the load from shifting. The load must also have adequate tiedowns.

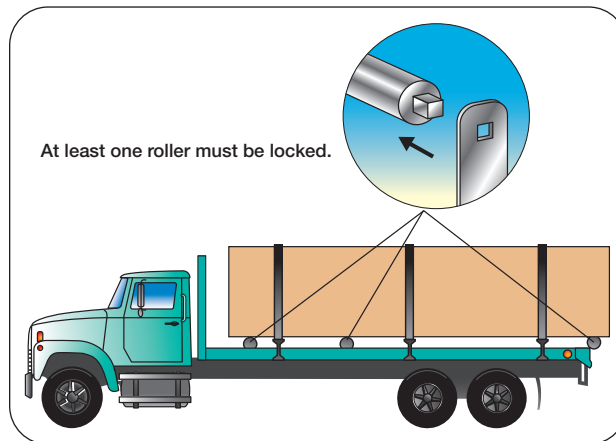

This load is supported on rollers and secured with tiedowns. Lock at least one roller.

Aggregate loads — An aggregate load is a collection of small articles. Sand, gravel, pieces of paper or wood chips are all types of aggregate loads. If these loads can't be contained with sideboards or tiedowns, you must use a cover or tarp so pieces don't escape from the vehicle.

You must use a cover or tarp to secure your load if:

- the load is made up of aggregate material, and
- the load is likely to bounce, blow or drop from the moving vehicle.

These two examples show the same kind of truck carrying different types of aggregate loads.

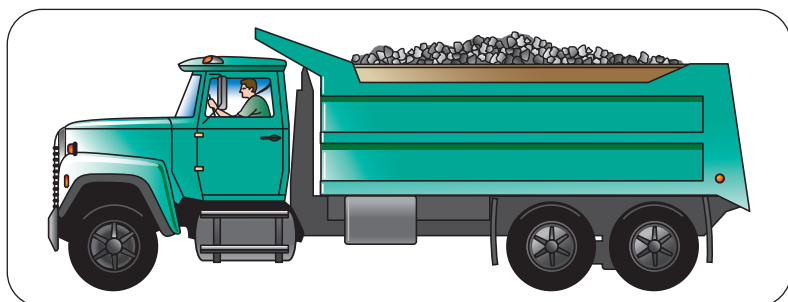

Since this dump truck is carrying $\frac{3}{4}$ -inch crushed stone, use a cover or tarp.

Since this dump truck has a full load of paper, debris and garbage, use a cover. Without one, parts of this load will probably blow out of the box.

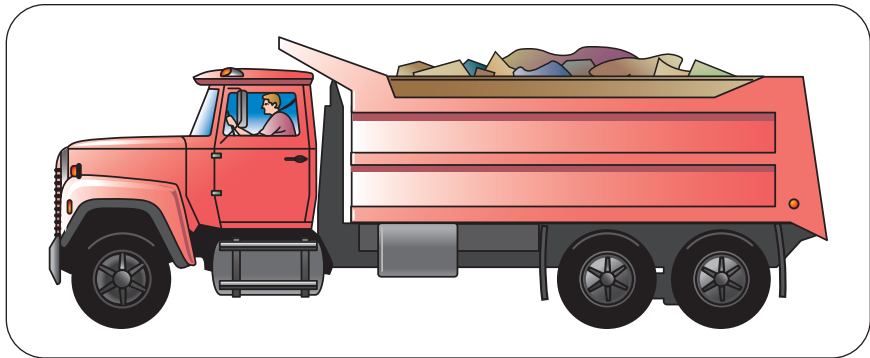

Remove any debris from the ledges outside the box and tailgate before you start your trip. Close the tailgate tightly against the box so the load can't escape through cracks.

Front-end structures

A cab shield (cab protector, bulkhead) is not considered a front-end structure or part of a cargo securement system under Standard 10. WorkSafe BC requires the use of cab protectors on logging trucks.

The Standard defines a front-end structure as a vertical barrier across the front of a deck that prevents cargo from moving forward. Division 5 of Part 1 of the Standard sets out requirements for front-end structures used as part of the cargo securement system, and Section 35.07 of the MVAR contains additional requirements for affixing and marking.

A front-end structure.

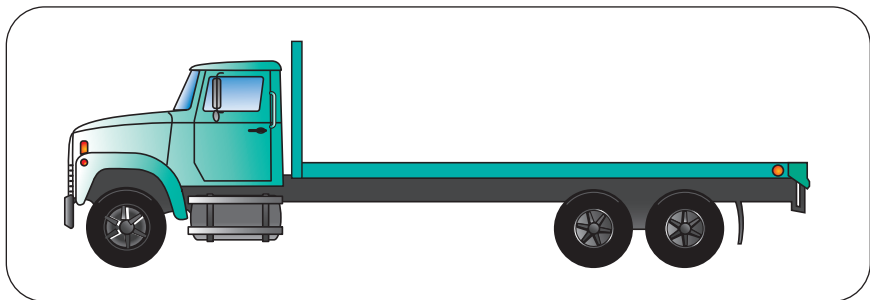

Strength — Front-end structures less than 1.83 m in height must be able to withstand a static load of at least 50 per cent of the total cargo weight uniformly distributed over the front-end structure. If it's 1.83 m or taller, then the structure must be able to withstand a static force equal to 40 per cent of the total cargo weight.

Height — To protect the vehicle operator, the Standard requires a front-end structure that's no shorter than 122 cm above the deck, or the height at which the front-end structure prevents the cargo from moving forward.

Width — The front-end structure must be no narrower than the width of the vehicle, or the width at which the front-end structure prevents the cargo from moving forward.

Penetration resistance — A front-end structure must be able to resist penetration by an article of cargo when the vehicle decelerates at a rate of 6.1 m/s^2 . A front-end structure must not have any openings or gaps that would allow an article of cargo to pass through.

fast fact

TAC is the Transportation Association of Canada. To determine whether your vehicle is a TAC vehicle, refer to the *Commercial Transport Regulations*. TAC vehicles must meet different standards from non-TAC vehicles.

fast fact

Front load projections on trailers can't extend more than a two metre radius beyond the articulation point for TAC (BC) vehicles or 2.25 m for non-TAC (BC) vehicles.

Here are two examples of acceptable front load projections. In the top illustration, the load extends a maximum of one metre beyond the front bumper. The bottom illustrations show two views of the same load. This load extends a maximum of a two metre radius measured from the kingpin (TAC (BC) vehicle).

Since the load on this vehicle exceeds the legal width requirements, you'll need an oversize permit. See **Oversize and overload permits** later in this chapter.

Marking/identification — A front-end structure must be attached according to its manufacturer's recommendations. It must also be identified in one of two ways:

1. permanently marked with its model number or serial number, the name and address of its manufacturer, and its rated capacity for cargo weight.
2. identified by a copy of a letter, signed by the manufacturer or a professional engineer and carried in the vehicle, that certifies its model number or serial number, and its rated capacity for cargo weight.

Load projections

Loads that project beyond your vehicle can cause problems. Projections take up additional road space and may intrude on other traffic lanes and space beside the roadway, especially when you're turning your vehicle. Allow yourself extra room when you transport cargo that has projections.

You must follow the standard limits for load projections unless you have a permit that allows you to extend your limit.

Front — Loads can't extend more than one metre beyond the front wheels. Or, if the vehicle is equipped with a front bumper, the load can't extend more than one metre beyond the front bumper.

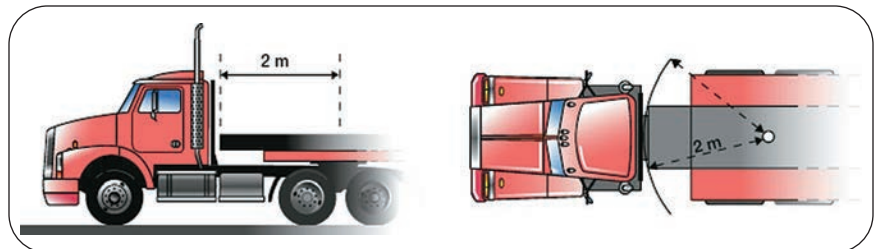
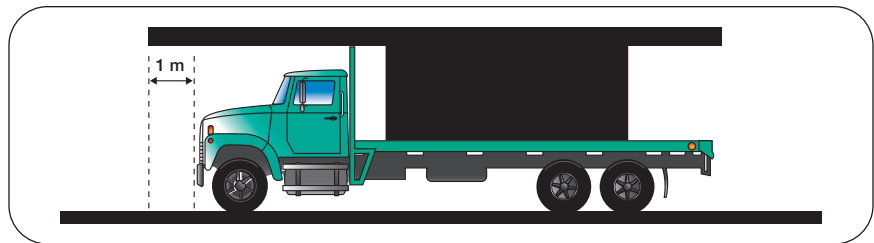

Sides — Loads can't be more than 2.6 m wide. Vehicles transporting loose hay or straw can't be wider than 3.1 m (vehicle and load).

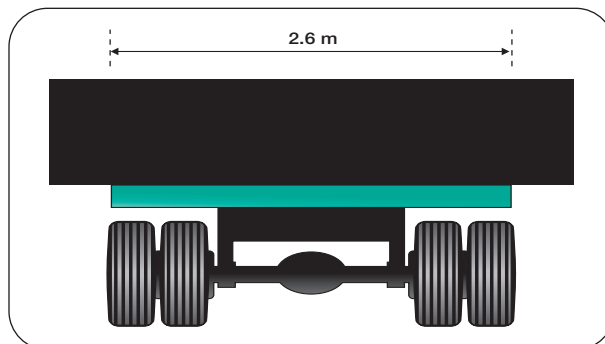

Rear — Loads on a straight truck can't extend more than four metres beyond the turn centre. If a load projects more than 1.2 m beyond the rear of the vehicle, attach a red flag or cloth to the tip of the projection if driven in daylight, or a red light if driven at night.

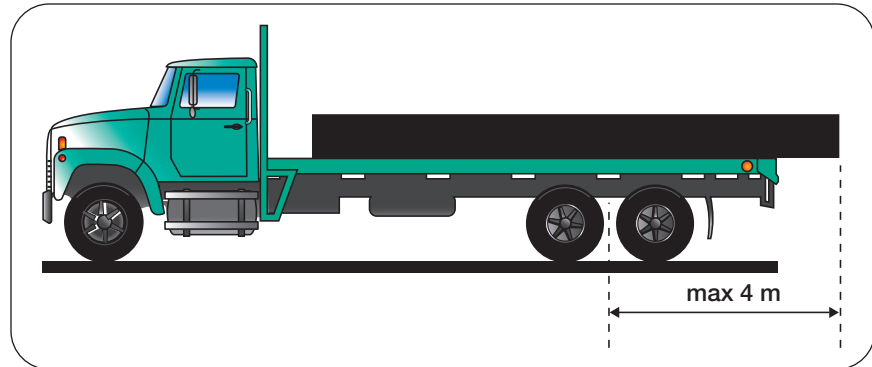

The standard (TAC (BC) vehicle) limit for a rear projection load.

fast fact

Cargo Security — Book 2, contains information on loading special cargoes. You can get *Book 2* at provincial weigh scales and at www.th.gov.bc.ca/cvse.

Specific cargo types

You could be carrying a variety of cargo types in your work as a commercial vehicle driver. The Standard outlines general cargo securement requirements that apply to all types of cargo. There are also specific requirements for different types of commodities (cargo) that you might carry. Unless otherwise specified in the Standard, the general and the specific requirements both apply.

The information given here is only a summary and doesn't include all the types of cargo. Refer to Standard 10 and Division 35 of the MVAR for details.

Logs

Some requirements for transporting logs or poles have been retained in MVAR 35.05, in addition to those in Division 1 of Part 2 of the Standard, because the Standard doesn't address requirements for bunk and stake assemblies.

Vehicles transporting logs or poles — Under section 29(1) of the Standard, these vehicles must be equipped with bunks, bolsters, stakes or other means of cradling the logs. Section 35.05 requires that stakes and stake extensions must form an angle of 90 degrees or less with the bunk cross member.

Stakes must be secured to the vehicle by one of these methods:

- by a method approved by a professional engineer
- by a pin and closed loop stake lines consisting of wire rope at least 22 mm in diameter
- with properly welded gussets of adequate strength.

Securely attach stake extensions to the stakes and bunks to the vehicle frame. Secure a pole, tri-axle or quad trailer to a truck by one securement device of sufficient strength.

Standard 10 provides the requirements pertaining to Log Configuration, as well as those for:

- shortwood loaded crosswise
- one stack of shortwood loaded crosswise
- two stacks of shortwood loaded crosswise
- long vehicles carrying shortwood loaded crosswise
- shortwood loaded lengthwise
- longwood loaded lengthwise
- pole trailers.

Inspecting log loads — Before a vehicle transporting logs enters a highway from a private road, the driver must inspect the vehicle, the logs and the securing devices to ensure compliance with the Standard. If required, the driver must make adjustments and add more securing devices. Standard 10 also provides that short logs loaded crosswise must be secured with a device that maintains tension at all times and automatically takes up slack in the tiedown as the logs settle.

Division 2 of the Standard outlines requirements for dressed lumber.

Building products

Bundles of lumber, drywall, plywood and similarly shaped building products must be secured in accordance with the requirements set out in Division 2 of Part 2 of the Standard.

Side-by-side bundles must either be placed in direct contact with one another, or prevented from shifting towards each other by dunnage or blocking.

You can secure bundles in two or more layers using a variety of methods:

1. If blocked from lateral movement by stakes on the sides of the vehicle, or by blocking or high friction devices between tiers, secure bundles by tiedowns laid over the top layer, with a minimum of two tiedowns for bundles longer than 1.52 m. Proper securement of bundles on a vehicle equipped with stakes is shown below.

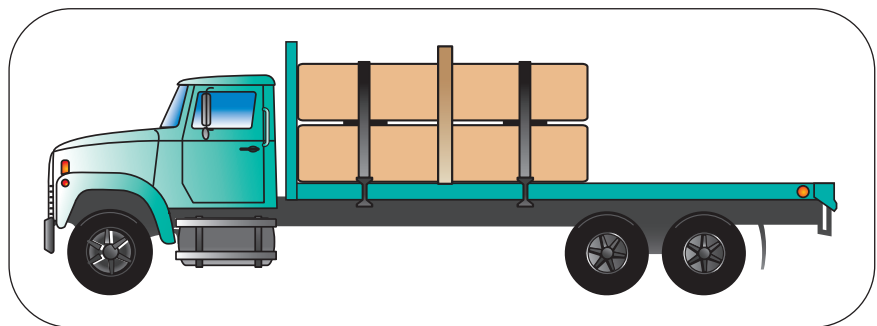

2. If the bundles are placed directly on top of one another, or on spacers of adequate size and orientation, secure by a combination of:
 - tiedowns over the top layer,
 - tiedowns over the second layer, or at 1.85 m above the trailer deck, whichever is greater, and
 - tiedowns for other multiple layers not over 1.85 m above the trailer.

For example:

If there are two tiers of bundles, each over 1.85 m in height, secure each tier by tiedowns in accordance with the general cargo securement requirements.

If there are three tiers of bundles and the bottom two tiers exceed 1.85 m in height, secure all tiers independently in accordance with the general cargo securement requirements.

If there are three tiers of bundles and only the topmost tier exceeds 1.85 m in height, then secure the bottom two tiers together and secure the top tier independently. This arrangement of bundles is shown below.

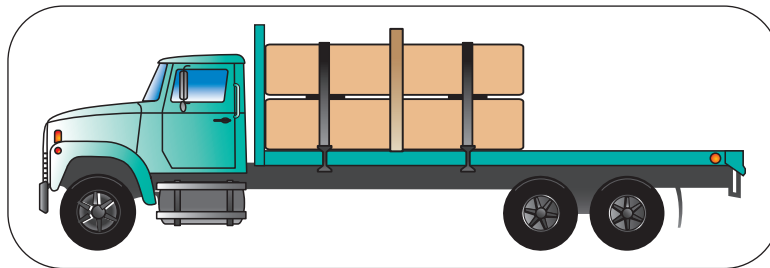

3. Secure bundles by tiedowns over each layer, with at least two tiedowns on each top bundle longer than 1.52 m, as shown below.

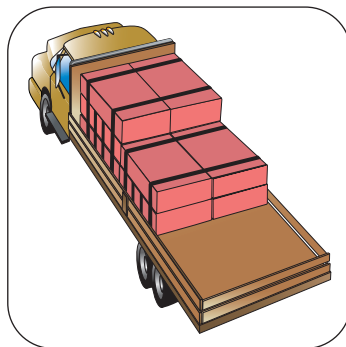

Metal coils

The Standard outlines specific requirements for transporting coils of rolled sheet metal where the shipment of coils weighs 2,268 kg or more.

Coils transported with eyes vertical must be prevented from tipping forward, rearward and sideways. Use blocking, bracing, friction mats or tiedowns to prevent forward and rearward movement of vertical coils. Secure coils transported with eyes crosswise or lengthwise against rolling as well as against forward and rearward movement.

Detailed requirements for securement of the various possible configurations of metal coils can be found in Division 3 of Part 2 of the Standard.

Paper rolls

Secure shipments of paper rolls weighing 2,268 kg or more in accordance with Division 4 of Part 2 of the Standard.

For rolls loaded in sided vehicles, use blocking, bracing, friction mats or tiedowns to prevent sliding, tipping or rolling. For stacks of rolls, use additional securement to prevent significant movement by upper layers. For rolls loaded on flatbed or curtain-sided vehicles, use additional tiedowns. Transporters of paper rolls should refer to the Standard for detailed securement requirements.

Concrete pipe

Securement of concrete pipe loaded crosswise on a flatbed vehicle is governed by Division 5 of Part 2 of the Standard. The general cargo securement requirements apply to concrete pipe transported in sided vehicles or loaded with eyes vertical or lengthwise.

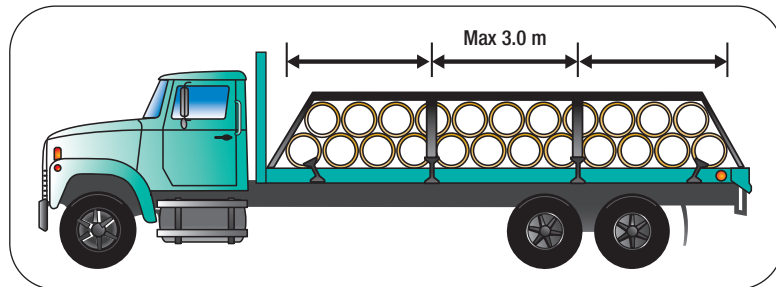

Group together pipes of different sizes within one load and secure separately. Immobilize the front and rear pipes in a single or bottom layer by blocking, wedges, vehicle structure or other equivalent means. Use tiedowns through the front and end pipes in order to firmly hold inner pipes in place. As shown above, place tiedowns both lengthwise and crosswise over groups of small pipe that aren't individually secured by tiedowns.

Large pipes require additional tiedowns through individual pipes. Detailed securement requirements are outlined in the Standard.

Intermodal containers

Division 6 of Part 2 of the Standard outlines securement requirements for intermodal containers. Secure cargo within the containers in accordance with the general cargo securement requirements or the commodity specific requirements.

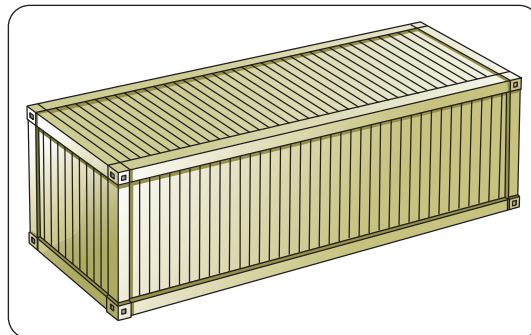

An intermodal cargo container.

Secure intermodal containers loaded on a container chassis vehicle to the container chassis with integral locking devices. These devices must ensure the cargo doesn't move more than the maximum set out in the Standard. While chain isn't an integral locking device, you can use it as an interim measure if the integral locking device is damaged or missing.

The corners of an intermodal cargo container have holes through which you pass a chain to secure the container to the vehicle. Hook the chain around an entire link, not simply through it.

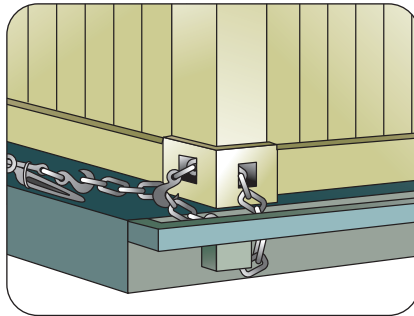

Secure intermodal containers transported on other types of vehicles to the vehicle by:

- chains, wire ropes or integral locking devices that are fixed to all the lower corners, and/or
- crossed chains that are fixed to all the upper corners

with an aggregate working load limit of 50 per cent of the weight of the container. Securement points don't need to be on the exact corners of the container.

Vehicles as cargo

In accordance with Division 7 of Part 2 of the Standard, vehicles with a GVW of less than 4,500 kg must be secured at both the front and rear with a minimum of two tiedowns. A winch may be used as a front tiedown. The general requirements for numbers of tiedowns don't apply. Heavy vehicles that weigh more than 4,500 kg must be restrained by a minimum of four tiedowns, each with a working load limit of at least 2,268 kg. Additional tiedowns may be required so that the aggregate working load limit of all tiedowns is at least 50 per cent of the cargo weight. Accessory equipment on heavy vehicles, such as hydraulic shovels, must be completely lowered and secured to the vehicle.

Stacked, flattened or crushed vehicles must be secured using containment walls, tiedowns, or a combination of these two methods. Tiedowns must have a working load limit of at least 2,268 kg and must not be synthetic webbing. Vehicles transporting flattened or crushed vehicles must have equipment that prevents loose parts falling from the load.

Roll-on/roll-off and hook-lift containers

Generally, roll-on/roll-off and hook-lift containers are carried on specially designed vehicles that are equipped with an integral securement system. Where a container is being transported on a vehicle without a functioning or compatible integral securement system, Division 8 of Part 2 of the Standard specifies a number of securement requirements.

Where a front stop or lifting device is missing, damaged or incompatible with the securing devices on a container, the container must be secured to the vehicle using manually installed tiedowns that provide the same level of securement as the component they replace.

If the vehicle doesn't have an integral securement system, the container must be:

- blocked against forward movement by the lifting device, stops or another restraint mechanism, such as a chain
- secured to the front of the vehicle by the lifting device, or another securing device, to prevent sideways and vertical movement
- secured to the rear of the vehicle using:
 - a tiedown attached to the vehicle chassis and the container (this tiedown may be attached to one rail)
 - two tiedowns installed lengthwise, each securing one side of the container to one of the vehicle's side rails
 - two hooks, or
 - equivalent mechanisms.

The same device may be used for securing the container to the front and rear of the vehicle.

Boulders

Secure boulders that weigh more than 5,000 kg, or have a volume greater than two cubic metres, as outlined in Division 9 of Part 2 of the Standard when transported on a flatbed vehicle or a vehicle that isn't specifically designed for transporting boulders.

Place a boulder with its flattest or largest side on the deck and support by at least two pieces of hardwood blocking or in a crib. Use at least two chains to secure the boulder to the vehicle. Non-cubic-shaped boulders with unstable bases require additional tiedowns.

Livestock

Livestock can be difficult to transport because the animals may move around in the trailer. This movement can make turns difficult, cause a collision and injury to the livestock. When you have less than a full load, use false bulkheads to keep livestock bunched together.

Reduce your speed on curves because animals — even when bunched — sometimes lean which can shift your vehicle's centre of gravity and cause a rollover.

Hanging meat

Meat suspended in a truck or trailer can sway. This type of load has a high centre of gravity, which increases the chances of your vehicle rolling over. Secure suspended items, so they can't shift or sway. Reduce your speed on sharp curves and take extra care on off-ramps and on-ramps.

Liquid or dry bulk tank loads

Liquid or dry bulk tank loads often have a high centre of gravity. This always increases the danger of a rollover. These loads will shift. If they aren't baffled, they'll surge forward, backward and side to side. Reduce your speed on curves and sharp turns and be especially careful on stops and starts.

fast fact

If you're going to work with dangerous goods, your current employer must certify that you've had appropriate training. Always carry your training certificate with you when transporting dangerous goods.

fast fact

Report immediately any incident involving dangerous goods in B.C. by calling the local police or the Provincial Emergency Program at 1-800-663-3456.

Transporting dangerous goods

Dangerous goods present a serious potential hazard to people who handle them, the public and the environment. People who have anything to do with dangerous goods have significant legal responsibilities and must be properly trained and appropriately certified.

When transporting these goods, you must ensure all shipping documents are complete, correct and readily available in the cab. These documents must accompany the dangerous goods shipment.

Report immediately any incident related to your dangerous goods cargo, like spills, leaks, fires, explosions or damaged containers to the nearest police agency or the Provincial Emergency Program. Your rapid action may help prevent an incident from becoming serious.

There are nine classes of dangerous goods: explosives, gases, flammable liquids, flammable solids, oxidizing substances and organic peroxides, poisonous substances and infectious substances, radioactive materials, corrosive substances and miscellaneous products or substances.



Class 1
Explosives



Class 2.1
Flammable gas



Class 2.2
Compressed gas



Class 2.3
Toxic gas



Class 3
Flammable liquids



Class 4.1
Flammable solids



Class 4.2
Spontaneous combustion



Class 4.3
Dangerous when wet



Class 5
5.1 Oxidizing substances
5.2 Organic peroxides



Class 6.1
Toxic substances



Class 6.2
Infectious substances



Class 7
Radioactive



Class 8
Corrosive



Class 9
Miscellaneous products,
substances or organisms



Mixed load

These are examples of some of the dangerous goods placards that may appear on the sides and both ends of transport trucks.

The sign on the left designates roads where vehicles transporting dangerous goods may travel. The one on the right designates roads where these vehicles can't.

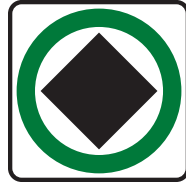

For more information on dangerous goods, see **chapter 13**.

Vehicle and load dimensions

The *Commercial Transport Act* sets limits for commercial vehicle lengths, widths, heights and weights.

Obey all Ministry of Transportation signs that limit the dimensions or weight of allowable loads, regardless of the licence or permit you carry. These signs are posted along highways to help you avoid damaging your vehicle, its load, the road or other highway users. Temporary additional weight restrictions can be posted at certain times of the year.

These signs all indicate that you need to make sure your vehicle has enough clearance.



This sign warns that the road narrows ahead.



**ONE
LANE**

The sign indicates that there is a one-lane bridge ahead, so you may have to yield to oncoming traffic on the bridge.



These signs indicate the height of an overhead structure such as a bridge or overpass. The diamond-shaped sign warns of low clearance ahead, and the rectangular sign may be mounted on the structure. Make sure your commercial vehicle has clearance, or else choose a different route.

These signs indicate truck routes.



Commercial vehicles are allowed to travel on this road.



Commercial vehicles aren't permitted on this road.



Commercial vehicles aren't permitted in this lane.

These signs indicate bus routes.



Buses are permitted on this road.



Buses aren't permitted on this road.

Height

Know the height of your vehicle and its load at all times. Highway signs posted before underpasses and tunnels give the height of their overhead clearances. In some areas, overhead check bars and warning devices are installed so you can test whether your vehicle is within the limits.

The maximum allowable height for a commercial vehicle is 4.15 m unless the driver has an oversize load permit.

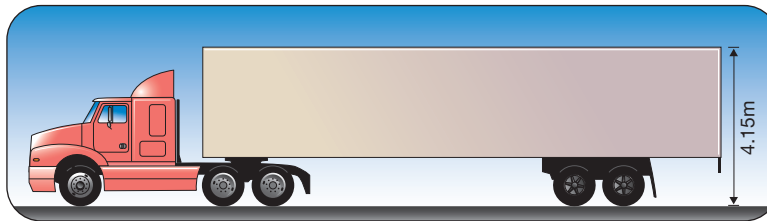

Width

Knowing the width of your vehicle is as important as knowing its other dimensions.

The maximum legal width of a vehicle and its load is 2.6 m unless the driver has an oversize load permit.

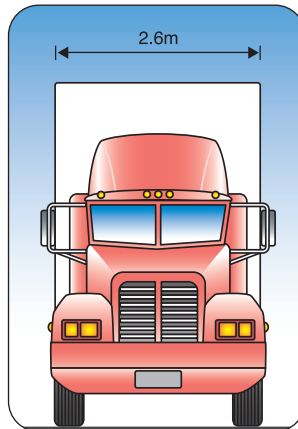

These items may extend up to 10 cm beyond the sides of a vehicle without being considered in that vehicle's overall width:

- anti-splash and spray devices
- devices to secure loads
- ladders
- dangerous goods placards
- glad hands and air connectors
- electrical or hydraulic connectors
- clearance lights.

fast fact

Side-view mirrors may extend up to 20 cm beyond the side of the vehicle. If they extend more than 20 cm, they are considered in the overall width of the vehicle.

Vehicles transporting loose hay, straw or fodder can be loaded to a maximum of 3.1 m overall width.

Side mirrors must always extend beyond your load, even when it's oversize, so you can see behind your vehicle.

Be particularly careful when you're driving an oversize vehicle on narrow bridges and in canyons, gorges and road-construction areas.

Winter driving conditions can add to the hazards of driving wide vehicles, particularly in the mountainous areas of the province. When winter weather affects driving conditions, the first rule of safety is **reduce speed**.

fast fact

The overall length for reefer vans or reefer trailers may be extended to include the refrigeration or heating unit.

fast fact

Watch for a sign that posts the maximum allowable weight whenever you approach a bridge.

fast fact

You must have a permit before you take an oversize vehicle on the road.

Length

Always be aware of your vehicle's length and the length of your load. You need to be particularly cautious while negotiating turns on narrow roads and in alleys.

Remember to leave enough clearance so you can avoid striking objects such as poles, parked cars and buildings. Anywhere that has limited clearance is a potential hazard.

Weight

Commercial vehicles are licensed according to their gross vehicle weight (GVW). You must know the weight of your vehicle and its load to ensure your vehicle doesn't exceed load limits.

Several terms are used to define a vehicle's weight. These include:

- **GVW** (gross vehicle weight) is the combined weight of the vehicle and its load.
- **GVWR** (gross vehicle weight rating) is a manufacturer's rating which defines the weight of a vehicle and the maximum load it should carry.
- **Licensed GVW** is the combined weight of the vehicle and the maximum load it's licensed to carry or tow. The minimum licensed GVW of most commercial vehicles is 1.5 times the net weight of the vehicle.

The *Commercial Transport Regulations* contain more detailed information about the dimension requirements for different vehicle combinations. Pick up a brochure about these regulations at any provincial weigh scales and at www.th.gov.bc.ca/cvse.

Oversize and overload permits

If your load can't be reduced and it's larger or heavier than regulations allow, you may be able to purchase an oversize permit.

You can purchase permits for overwidth, overweight, overlength, or overheight loads. If you plan to travel on the highway, you can apply by calling the *Commercial Vehicle Permit Line*.

These permits are issued according to *Commercial Transport Regulations*.

When you apply for a permit you must provide:

- registration and insurance papers for both the tow vehicle and the trailer(s)
- specifics on the load you'll be carrying
- details about your planned route and destination
- a time when you plan to move your oversized load.

If you're applying for an overload permit, you'll also have to identify the amount of weight that will be on each axle of your vehicle.

fast fact

To move oversize or overweight loads on city or municipal roads, you may need to get a permit from the local city government or municipal authority.

fast fact

If your load can't be broken into smaller amounts and is overweight or oversize, you may be able to purchase a permit to exceed standard limits.

fast fact

It's estimated that one heavy vehicle passing over a roadway can cause up to 5,000 times more damage than a single passenger vehicle, depending upon the heavy vehicle's configuration and loading.

When you receive a permit, you'll also be given a list of requirements you must fulfill including some or all of the following:

- pilot car(s)
- flags
- signs
- lights
- time of day you may travel
- days of the week you may travel
- the route you must use.

Overload permits

Overloading your vehicle can make steering, braking and controlling your speed more difficult. Use extra caution when driving overloaded vehicles. Be prepared to drive slowly on upgrades and be careful not to lose control of your speed when going down hills.

A vehicle or combination of vehicles is overloaded whenever:

- the vehicle and its load exceed the GWV allowed under the *Commercial Transport Regulations*, or
- the vehicle(s) and its load weigh more than its licensed GWV, or
- the vehicle and its load exceed the maximum allowable weight on any single or group of axles.

Overload permits are issued only when loads can't be reduced or when a vehicle isn't licensed up to its allowable weight.

Oversize permits

If your vehicle's wider, longer or higher than regulations allow, you must have an oversize permit before operating on any highway. This applies whether your vehicle is loaded or not. Permits for loaded vehicles are only given when the load can't be reduced.

Permits are not normally given for loads or vehicles that are wider than 4.4 m.

The extremities of all oversize vehicles or loads must be marked with red flags that are at least 30 cm by 30 cm. For night travel, lights are required on the extremities — amber to the front and red to the rear.

Pilot cars

As a condition of an oversize or overload permit, a pilot car may be required.

A pilot car warns other drivers about the larger-than-normal vehicle they're about to encounter.

Your permit may require more than one pilot car depending on your route and the load.

Signs

You must display the appropriate signs whenever you transport an oversize load.



WIDE LOAD

This warns that the vehicle being driven is carrying a wide load.



LONG LOAD

This warns that the vehicle being driven is carrying a long load.



OVERSIZE LOAD

This warns that the vehicle being driven is carrying an oversize load.



When required, a D (for over dimension) sign must be carried by a pilot car.

fast fact

Pilot car sign regulations are detailed in Division 8 of the *Commercial Transport Regulations*.

fast fact

An inspector or police officer may be a commercial transport inspector, motor vehicle inspector, constable or a special constable.

Distance from oversize vehicle

A pilot car must travel between 100 and 500 m either behind or in front of the oversize vehicle it's escorting.

Reporting to weigh scales

Fixed location and portable weigh scales are found throughout B.C. If you drive a commercial vehicle with a licensed gross vehicle weight of more than 5,500 kg, you must report to a scale whenever a sign, a police officer or an authorized person directs you to do so. Your vehicle will be weighed and inspected at the scale.

An inspector or police officer may ask you to park your vehicle and bring your papers into an office. If this happens, take in all registration and permit papers for your vehicles as well as your log book and trip inspection report.

Fixed weigh scales

Weigh scales are permanently located throughout B.C. Highway signs direct drivers to their locations. Drive your vehicle onto the scales when you enter the scale yard. The scale will measure the weight on your axles or axle groups. A peace officer will check your tires and measure your vehicle and its load. Follow the directions on the light board.



Highway signs that direct you to pull into a weigh scale.

Portable weigh scales

Inspectors with portable weigh scales travel throughout B.C. They may be found on any public road. You may encounter a portable weigh scale in two different ways:

- It may be temporarily set up on the side of a road and you'll be signalled to stop.
- A vehicle with flashing lights may direct you to pull over to the side of the road — at that time the inspector in the vehicle may set up a scale.

Review questions

1. What can cause your trailer to jackknife when you're backing up?
2. What actions should you take if your trailer whips or swerves?
3. When a coupling device (other than a fifth wheel) is used to join vehicles in combination, is an additional coupling device such as a chain or cable required?
4. Except for a pole trailer, what's the maximum length permitted for a draw bar or coupling device between vehicles?
5. When coupling a tractor to a semi-trailer, should the air lines be connected to the trailer before or after connecting the kingpin to the fifth wheel?
6. How do you check that the fifth wheel jaws have locked to the trailer pin?
7. To uncouple a tractor from a semi-trailer, are the air lines unhooked before or after separating the fifth wheel from the trailer pin?
8. Why's it necessary to block the wheels of a trailer that will be left for any length of time?
9. What's a converter dolly and when's it used?
10. For which type of trailer connection are safety chains or cables required — a fifth wheel connection or pintle hitch connection?
11. What's the location of a single-unit truck's central weight distribution point?
12. What could result from placing too much weight over any one set of wheels or over any one axle?
13. Should the majority of the weight of a load on a single-unit truck be placed directly behind the cab, slightly ahead of the rear axle or slightly behind the rear axle?
14. Should the majority of the weight of a load on a semi-trailer be placed directly over the fifth wheel, at the midway point of the trailer or directly over the trailer axle?
15. What are the two methods or categories of securing cargo for transporting?
16. What's dunnage and why's it used?
17. What's the rough guide for spacing tiedowns to secure your load?
18. Why must you compare the weight of your load to the strength of your tiedowns?
19. What types of loads must be covered with a tarp?
20. What's the safe working load of a tiedown?
21. What's a tiedown assembly?
22. What's a load binder and why's it used?

23. Why must you protect tiedowns from rubbing against your load?
24. What are the dangers in transporting livestock?
25. What are two types of loads that have a high centre of gravity which, if not adequately secured to prevent movement or swaying, can increase the chances of your vehicle rolling over?
26. Why's it important for you to know the height and width of the vehicle you're operating?
27. Why's it necessary to know the gross vehicle weight (GVW) of the vehicle you're operating?
28. What factors determine the maximum allowable GVW for which the vehicle may be licensed?
29. Do load limit signs at the approach to bridges and structures apply to all vehicles?
30. Are you allowed to display Wide Load signs on your vehicle when a wide load isn't actually being transported?
31. What's the maximum legal width of a vehicle that'll be operated on a highway?
32. What's the maximum length a load may project to the rear?
33. What's required before oversize or overweight loads may be transported?
34. What are the conditions for obtaining a permit to transport overweight or oversize loads?
35. Are all commercial vehicles required to report to weigh scales?

This chapter provides information about the skills and knowledge you need to be a bus, taxi, limousine or ride-hailing vehicle operator. The information here relates particularly to Class 2 and Class 4 vehicles.

What you'll learn

After studying this chapter you'll be able to:

- define the various types of Class 2 and Class 4 vehicles, and describe their uses
- describe how to safely deal with common driving situations
- identify and describe key regulations that apply
- list and describe the requirements for operating a school bus
- describe the special considerations and regulations for driving an emergency vehicle.

Drivers of Class 2 and Class 4 vehicles must understand a variety of terms defined by the *Motor Vehicle Act* and the *Passenger Transportation Act* and their regulations. A few of the more important ones you need to know before reading this chapter are:

Public transportation — transportation of groups of people who aren't your associates or members of your family

Commercial passenger vehicle — a motor vehicle used to transport passengers for compensation

Compensation — includes money or other form of remuneration or reward

Bus — a motor vehicle that has a seating capacity of more than 10 persons, including the driver, which is operated for hire or for public transportation

Special activity bus — a bus that:

- a. conforms to the safety standards set out in *Motor Vehicle Safety Act* (Canada) that applied to this vehicle when it was manufactured
- b. is operated by, on behalf of, or at the request of the authority in charge of a school, *and*
- c. is used for non-scheduled transportation

Special vehicle — a motor vehicle that has a carrying capacity of not more than 10 persons, including the driver, which is designed or modified for public transportation of persons with disabilities

Taxi (or limousine) — a motor vehicle designed to carry not more than 10 persons, and that's available with its driver for hire, and includes a vehicle when being used as part of a ride-hail service

Large capacity limousine — a motor vehicle capable of carrying more than 10 and up to 24 persons, including the driver.

As of March 29, 2005, these vehicles are allowed to operate in B.C. if they have obtained the National Safety Mark, indicating compliance with the *Canadian Motor Vehicle Safety Standards (CMVSS)*.

For such vehicles manufactured before January 1, 2005 that don't comply with CMVSS, contact Commercial Vehicle Safety and Enforcement.

A bus and a vehicle used as a taxi or for ride-hailing — examples of passenger-carrying vehicles.

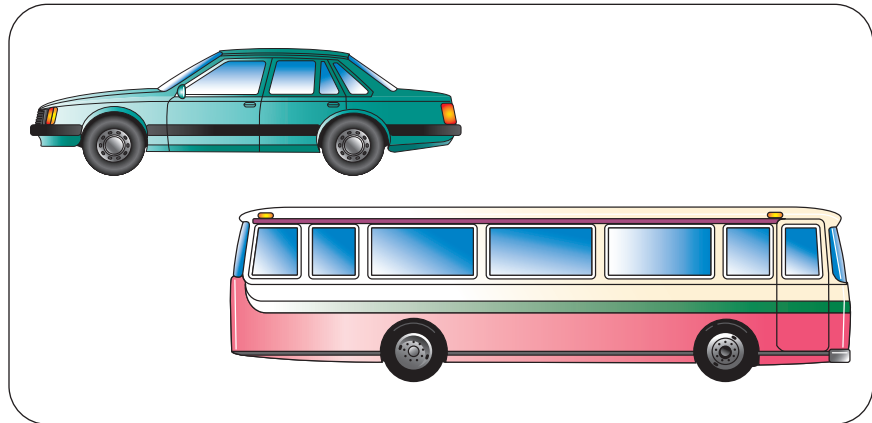

Passenger safety

Your most important concern must be the safety of your passengers. Ensuring your passengers' safety is always more important than meeting schedules.

You can best protect your passengers by making certain that the vehicle you use to transport them is safe and by operating it properly.

When bus passengers are injured, it's usually because the driver:

- stops too quickly or abruptly
- starts too quickly
- turns too quickly or abruptly
- opens or closes the doors too quickly
- fails to check on passengers frequently enough while driving.

You can prevent many passenger injuries by smart driving. Keep a safe distance behind other vehicles so you won't be forced to stop quickly if the vehicle in front of you stops suddenly. Passengers may be jolted and injured during a quick stop. Avoid getting blocked in by other vehicles so you have an escape route if trouble develops ahead of you.

Use the controls on your bus carefully. Make your starts and turns smoothly. Check on your passengers. Ensure that they're not moving around in the aisle when the bus is moving and that they're completely on or off the bus before you close the doors.

Manoeuvring

You need to understand the handling characteristics of your vehicle in order to transport your passengers safely and comfortably. Commercial passenger vehicles are usually taller, wider, larger and handle differently from most other passenger vehicles. Many of these differences are covered in **chapter 3, basic driving skills**. Other skills specific to driving buses, taxis, limousines and ride-hailing vehicles are included in this chapter.

Large buses handle differently from most other vehicles, especially when turning. Leave enough room when you make a right turn to avoid a collision with the vehicle in the lane beside you.

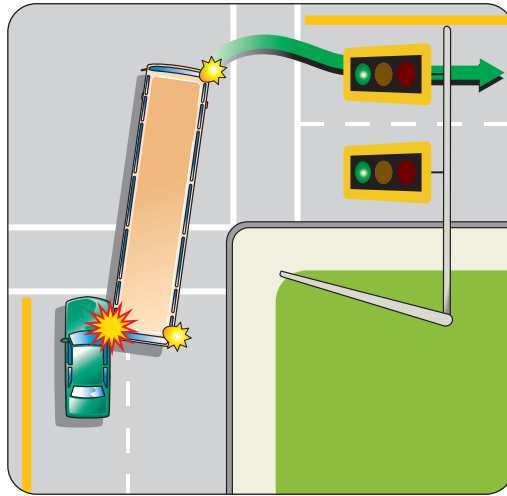

Leaving the curb

Look in the side mirror and over your shoulder to check that traffic is clear before you leave the curb. Don't rely on your side mirrors alone. As you prepare to leave the curb, ensure your passengers are not moving around. Signal other drivers to let them know you plan to move into the traffic flow and check over your shoulder again.

Be careful that the rear of your bus does not swing over the sidewalk as you pull away from the curb. If it does, it could hit pedestrians, cyclists, poles or sign posts that are near the curb.

Ensure the back end of your bus doesn't hit pedestrians, cyclists, poles or sign posts as you are pulling away from a curb.

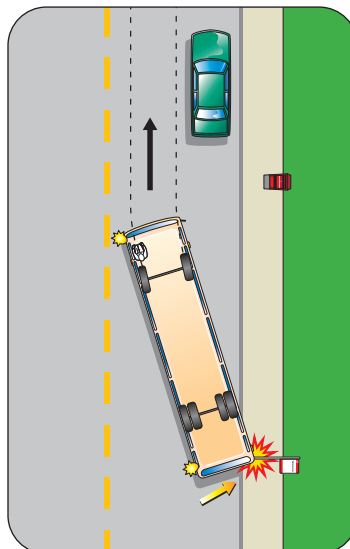



This sign is displayed on the back of public transit buses to indicate to drivers that buses have the right-of-way when pulling away from the curb or a bus stop.

Watch for cars parked close to the front of your vehicle and for vehicles that may be approaching from the opposite direction as you leave the curb.

Bus right-of-way

The *Motor Vehicle Act* gives public transit buses the right-of-way when a bus driver signals to move from the curb lane or a bus stop into the traffic flow and the bus displays a sign telling motorists to yield. This rule applies to areas where the speed limit is less than 60 km/h.

This regulation doesn't remove any responsibility from public transit bus drivers. As a bus driver, you're still required to ensure it's safe before you move from the side of the road into traffic. Don't assume you have the right-of-way, as other drivers don't have to yield if it's unsafe.

Passing parked cars

You'll often drive in urban areas on streets with parked cars. These vehicles can create a variety of hazards. When you drive past parked vehicles watch for:

- vehicles pulling into traffic
- doors opening suddenly on the traffic side
- pedestrians stepping out from between cars.

These clues can help you avoid a collision with people or parked vehicles:

- front wheels turned out
- a driver sitting behind the steering wheel
- exhaust from a tail pipe
- brake lights, back-up lights and turn signals
- people walking or children playing near the road.

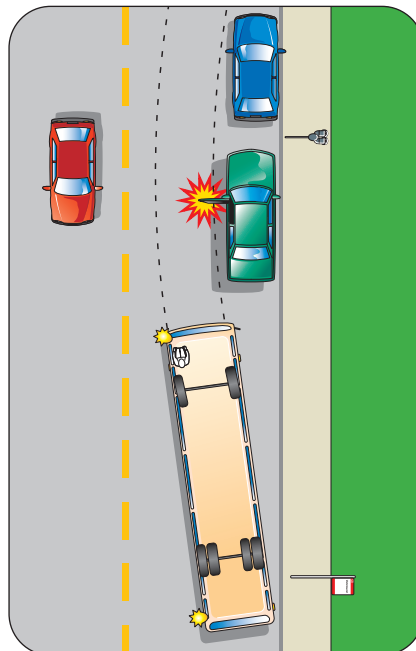

Watch for warning clues to ensure you don't collide with parked vehicles or the people near them.

fast fact

All illuminated taxi signs must meet *Motor Vehicle Act* specifications for type, colour and size.

Operating a bus, taxi, limousine or ride-hailing vehicle

You must have a passenger transportation licence if you're responsible for a vehicle which transports passengers on a for-hire basis. You must also be familiar with all relevant acts and regulations.

Taking on and letting off passengers

When you're taking on or letting off passengers on the highway:

- signal to warn traffic that you're stopping
- stop in a location that allows other drivers to see your vehicle from a distance of at least 85 metres (285 ft) in front and behind
- leave space to the left of your vehicle so that traffic may pass by — you should leave at least three metres (10 ft) so traffic can pass.

Whenever it's safe, pull your vehicle off the travel portion of the highway while your passengers are getting on or off.

Smoking

It's illegal to smoke in any motor vehicle when there are any passengers under 16 years old.

Children travelling in vehicles are especially vulnerable to second-hand smoke. These harmful effects are heightened in small enclosed places like motor vehicles and can have immediate and serious, long-lasting health consequences.

Focus on driving

The safety of your passengers is your first priority. This means that any time your vehicle is moving you must not collect fares, make change, take on or let off passengers. You should also save any unnecessary conversation with your passengers until you've stopped your vehicle.

Nothing or no one in your vehicle should get in the way of allowing you to do a safe job. You must be able to clearly see ahead, to the right and to the left. You must be able to move your arms and legs at all times and be ready to reach for emergency equipment.

You may have up to two passengers sitting on your right side in a sedan-type vehicle, but only if there's enough room for you to operate the vehicle safely and only if there are designated seating positions with seatbelts in these positions.

Standing passengers

Passengers may not stand while a vehicle's in motion, unless the passenger transportation licence for that vehicle allows standing passengers. This licence will limit the number of standing passengers you may carry.

Your vehicle's standing passenger capacity must be displayed in an easily seen location in the vehicle. Don't allow any passenger to stand in a place that could make it difficult for you to see or move.

Refusing to transport passengers

It's your duty to provide transportation to all paying customers. But you may refuse to transport a passenger if:

- your vehicle's already carrying the maximum allowed number of passengers
- the passenger is:
 - smoking
 - using profane or offensive language
 - acting in a disorderly manner or being offensive to other passengers.

If you order a person out of your vehicle, you must ensure that the person can disembark safely and in a location where they can reasonably be expected to find alternate transportation.

Let-down or jump seats

Under the *Passenger Transportation Act*, you must have a licence or permit before you use a let-down or jump seat in a passenger vehicle. These seats may be used only in the rear of sedans and only if the manufacturer has designed the vehicle to carry them.

Transporting people with disabilities

You need special skills, knowledge and sensitivity to transport people with disabilities. You can't refuse to transport an individual just because that person has a disability. Some people with disabilities travel with an assisting animal, such as a guide dog. You must allow these animals in your vehicle with their owners.

Tips for transporting persons with disabilities:

- speak directly to the person with the disability, not to their companion or assistant
- don't assume the person needs help — always ask before giving help
- remember that every person's unique and people's needs and abilities will vary greatly
- be patient, flexible and creative in the way you communicate.

This type of vehicle is used to transport persons with disabilities.

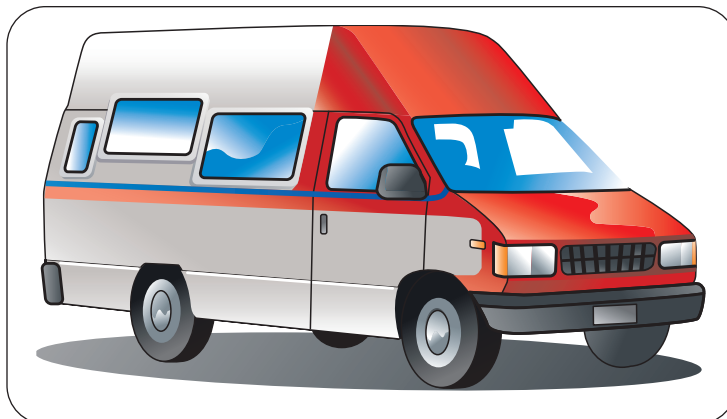

Properly secure wheelchairs, scooters and other mobility aids. Provide assisting animals with space that'll keep them and everyone else in the vehicle safe if there's a collision.

See **chapter 13, for more information**, to find out where you can learn more about transporting people with disabilities.

Chauffeur's permit

Some municipalities require all limousine and taxi drivers to have a chauffeur's permit. This permit is usually issued by the municipal police. You may have to allow a police check and complete a hospitality course (such as the TaxiHost program) before you'll be given a permit.

Inside lights

Public passenger vehicles with a seating capacity of more than 12 occupants, including the driver, must have a light or lights inside the vehicle that light up the passenger aisle behind the driver.

These lights must be kept on between the hours of sunset and sunrise so passengers can move safely in the vehicle.

Passenger vehicles must also have a light at each entrance that turns on when the door's opened.

Vehicle cleanliness

Your bus or taxi must be clean and sanitary at all times.

Vehicle inspection

If your vehicle's licensed in British Columbia and has a passenger transportation plate, you must ensure that it displays a valid commercial vehicle inspection decal and carry the certificate in the vehicle.

Emergency equipment and exits

Every commercial passenger vehicle (as defined in the *Passenger Transportation Act*) that has a seating capacity of more than 10 occupants, including the driver, must have:

- one first-aid kit (that meets the WorkSafe BC guidelines)
- one spare tire
- at least one fire extinguisher.

The carrier is responsible for ensuring this emergency equipment is available and in working order.

Passenger vehicles that have a seating capacity of more than 12, including the driver, must be equipped with an emergency exit door or emergency windows. Large capacity limousines must meet *Canadian Motor Vehicle Safety Standards* regarding emergency exits.

Vehicles that have a seating capacity of more than 10 passengers must carry warning devices such as flags and flares. For more information, see **chapter 3, basic driving skills**.

Defects and breakdowns

You must end the trip if your vehicle develops a problem that could endanger the safety or comfort of any of your passengers. Fix the problem or remove the danger before you continue the trip with your passengers.

You must make immediate arrangements to have your passengers transported to their destination with as little delay as possible if a crash or breakdown makes it impossible for you to continue.

Fuelling

Don't refuel your vehicle while the engine is running, on-board radio is transmitting or when any open flame is present. Keep the nozzle of the fuel hose in contact with the filler pipe on your vehicle at all times when refuelling to ground the connection. If there's a ground strap, also connect it to the filler pipe.

Baggage

You're responsible for all baggage passengers bring into your vehicle. You must ensure it's loaded safely. Don't strain yourself by lifting or moving heavy baggage. Load all baggage so that it doesn't interfere with passengers getting on or off the vehicle and can't fall on or against any passenger. It's important to protect all baggage from dust and moisture.

The *Motor Vehicle Act Regulations* place strict limits on the transportation of cargo or baggage in the passenger compartment of buses. Cargo must be carried:

- in overhead racks adequately designed and constructed, and equipped with an elastic rope or cord, doors, or a rigid vertical edge equal to half the height of the remaining opening
- stowed under the seats and against a barrier which prevents forward movement
- in a separate compartment enclosed on all sides, or
- on a passenger's lap.

Baggage or cargo must not block or partially block any aisle or exit.

In addition, a bus shouldn't be loaded in a way that:

- obscures the driver's view to the front, left or right
- obstructs access to emergency equipment
- interferes with the movement of the driver's arms or legs, or
- hinders the safe operation of the bus.

Smoking and using alcoholic beverages

Don't smoke if passengers are in your vehicle. This applies whether your vehicle's moving or not.

Don't be under the influence of alcohol while on duty.

fast fact

Cargo Security — Book 2, contains information on loading special cargoes. Book 2 is available at provincial weigh scales and at www.th.gov.bc.ca/cvse.

Reporting a defect or deficiency

You must report any defect or deficiency that could make your vehicle unsafe. This report must be made in writing and it must be given to the carrier you work for at the time you find the defect or by the end of that day.

Operating a school bus

Requirements for operating a bus also apply to school buses. Any passenger vehicle that operates as a school bus must also comply with all parts of the MVAR that relate to school buses.

The other vehicles are stopped and waiting for passengers to unload from the school bus before proceeding.

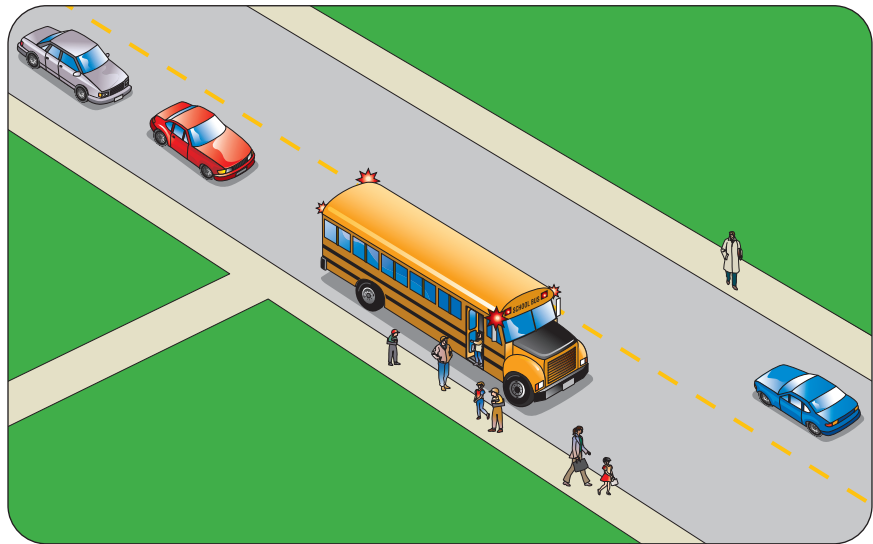

Unfit vehicles

If any mechanical inspector or peace officer finds that a school bus is unfit, you can't operate that vehicle as a school bus until the defect(s) has been fixed.

Rental buses

Any rental vehicle you rent to temporarily replace a school bus must comply with all parts of the *Motor Vehicle Act* and regulations that pertain to school buses. You must also notify Commercial Vehicle Safety and Enforcement about the change in vehicles as soon as possible.

Brake maintenance

Test the brakes on your school bus every day. Don't operate any school bus unless the brakes are safe.

Mechanical defects

Never transport passengers on a school bus that's defective in any way. Your first responsibility is to keep your passengers safe.

Refuelling

Ensure that all passengers are off the bus and the engine is turned off before you refuel.

Emergency equipment and exits

Every school bus must be equipped with emergency equipment, including:

- an approved fire extinguisher
- an approved first-aid kit
- flares or flags.

Passenger vehicles with a seating capacity of more than 12, including the driver, must be equipped with an emergency exit door or emergency windows.

Vehicles with a seating capacity of more than 10 passengers must carry warning devices such as flags and flares.

Refer to **chapter 3, basic driving skills**, for more information about emergency equipment.

School bus signs

All school buses must display two signs that say "School Bus." The letters on these signs must be at least 20 cm high and be black on a yellow background. These signs must be mounted at the front and rear of the school bus, with the rear sign either immediately above or below the rear window.

Exterior mirrors

Every new school bus must have:

- Two sets of rear-view mirrors on each side of the bus to provide a good view of the highway to the rear and along the right and left sides of the school bus, and to observe passengers and road users immediately beside the school bus.
- A mirror to give a good view of the entrance door to the school bus so that you can observe passengers getting on and off the bus.
- A convex mirror at the front to give you a good view of the roadway immediately in front of the school bus to observe passengers who may be crossing in front of the school bus.

Make sure these mirrors are properly adjusted so that they provide the view they are intended to show.

Passengers must be seated

Passengers are not allowed to stand on a school bus. Ensure that all passengers are sitting before you move the bus.

Cleanliness

The floor of your school bus must be washed with a disinfectant solution at least once a week.

Taking on and letting off passengers

Before you open the doors of your school bus to let passengers on or off, ensure that:

- your vehicle has come to a full stop
- there are at least three metres of road available on the left side of your vehicle
- other drivers will be able to see your bus from at least 60 metres in either direction
- passengers enter or leave your school bus from the right side only.

School buses are equipped with alternating flashing red lights, swing-out stop signs and may also have flashing amber lights which are displayed with the flashing red lights. Use the alternating flashing red lights to alert other drivers whenever your passengers are crossing the road before they enter or after they leave your bus.

A school bus with a swing-out stop sign and flashing red lights.



All drivers are required to stop their vehicles when a school bus displays flashing red lights.

New school buses may also be equipped with a crossing control arm that extends in front of the bus to help you see passengers as they cross in front of the school bus.

Take extra care if passengers are crossing the road in front of your bus to see that they're clear of your path before you move off.

Turn off your flashing lights and draw in your stop sign after your passengers are safely in your vehicle or safely across the road. As a courtesy, allow any traffic that's waiting behind you to go ahead before you move back onto the road.

Operating emergency vehicles

Ambulance drivers use flashing red lights to warn other drivers when it is essential that they get the right-of-way. These lights are to be used only when the ambulance is responding to an emergency call or transporting a patient.

You may drive an emergency vehicle faster than posted speed limits and drive through red traffic lights or past stop signs if you give other drivers the appropriate warning. Ambulances are equipped with audible signal bells, sirens or exhaust whistles and flashing red lights. Use both lights and the siren to warn other drivers. Use caution at all times because other drivers may not see or hear your warning.

Whenever you exceed the speed limits or drive through stop signals, you must think about:

- the condition and use of the highway
- the amount of traffic that's on, or is expected to be on, the highway
- the seriousness of the emergency you're responding to.

An ambulance is an emergency vehicle that uses flashing red lights to get the right-of-way.

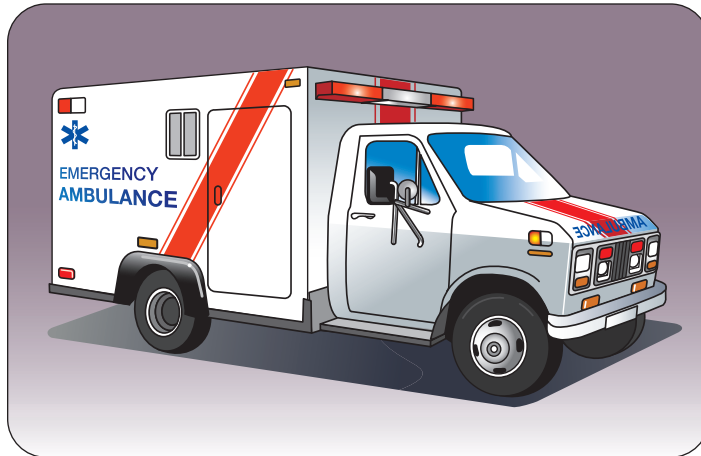

Review questions

1. What's your most important concern when operating a vehicle used for transporting the public?
2. In addition to checking the left-side mirror, where should you look before leaving the curb?
3. As the driver of a bus, what precautions must you take when leaving a parked position where poles or sign posts are located near the vehicle?
4. Should you turn on the vehicle's signal lights before you're ready to leave the parking position?
5. What are some clues you can use to avoid a collision when passing parked vehicles?
6. Under what highway conditions may a taxi or bus take on or let off passengers on a highway outside the limits of a city or municipality?
7. What width of roadway must be left unoccupied by and beside the bus when stopping to take on or let off passengers?
8. Is it allowable for you to collect a fare or make change while the vehicle's in motion?
9. In a sedan-type vehicle, how many passengers may occupy the front seat in addition to the driver?
10. Are passengers permitted to stand on a bus and, if they are, where may they stand?
11. As the driver of a commercial passenger vehicle, under which conditions are you permitted to refuse to transport or carry any persons?
12. Is it necessary to have working lights that illuminate the passenger aisle of a bus?
13. At what times of the day are inside lights in public passenger vehicles to be illuminated?
14. What action would you take if the commercial passenger vehicle you are driving broke down and you could not continue the trip?
15. What precautions must be taken when refuelling public passenger vehicles?
16. What's the minimum safety equipment you're required to carry in a commercial passenger vehicle with a seating capacity of more than 12 occupants, including the driver?
17. Who's responsible for ensuring that the safety equipment is available and in working order?
18. What are the baggage restrictions that apply when loading or carrying baggage on a bus?
19. What are the smoking restrictions for drivers of public or limited passenger vehicles?

20. How often is it necessary to test the brakes on a school bus?
21. When a school bus has a defect, can you operate the vehicle before it has been fixed?
22. Can any school bus be fuelled while its engine is running or with any passenger inside it?
23. How many signs that read school bus must be displayed on a vehicle that's being operated as a school bus?
24. In addition to the regular outside rear-view mirrors, what type of mirror must be installed on cab-over or forward-control type school buses?
25. As the operator of any school bus, can you allow any passenger to stand while the vehicle's in motion?
26. As the operator of a school bus, how often are you required to wash the floor of the vehicle with water containing a disinfectant solution?
27. As the driver of a school bus, can you start the vehicle in motion before every passenger is seated?
28. Can a person be allowed to board or leave a school bus other than from the right side?
29. When operating an ambulance, when are you permitted to use flashing red lights?
30. When operating an emergency vehicle, what conditions must you take into account before exceeding speed limits or driving through stop signals and traffic signal lights?

This chapter provides information on the rules and regulations governing how many hours drivers may work, when drivers must have rest periods and the records drivers must keep to track their hours of work and rest.

What you'll learn

After studying this chapter you'll be able to:

- define and provide examples of off-duty and on-duty time
- define and provide examples of on-duty driving and on-duty-not-driving time
- explain how long you can drive before you must take a break
- list the minimum requirements for filling in a logbook
- describe the hours of service requirements in other jurisdictions.

fast fact

For more information about the NSC as it's applied in B.C., refer to Division 37 of the *Motor Vehicle Act Regulations* or check the Commercial Vehicle Safety Enforcement website at www.th.gov.bc.ca/cvse.

National Safety Code

The National Safety Code (NSC) sets out minimum safety standards for commercial vehicles, drivers and carriers operating in Canada. Carriers are responsible for ensuring their drivers and vehicles meet these standards.

You will need to understand NSC regulations to perform your job safely. These regulations will help you protect your life and the lives of others, as well as your livelihood. NSC applies to you if you drive a motor vehicle that's used to transport people or freight for any business purpose.

The following vehicles are included in the National Safety Code program:

- commercial vehicles licensed with a GVW more than 5,000 kg
- vehicles operating under the *Passenger Transportation Act* including taxis, buses and limousines
- commercial vehicles that have a seating capacity of 10 or more passengers plus the driver.

Hours of service

Hours of service regulations are designed to limit the time you can spend driving. Statistics show that a fatigued driver is more likely to be in a crash.

Hours of service regulations have been in effect since the 1980s. These rules have since been revised to reduce the risk of fatigue-related commercial vehicle crashes by providing drivers with more opportunity to obtain additional rest.

On-duty time

On-duty time is the period when you begin work or when a carrier requires you to be ready to start work. On-duty time ends when you stop work.

You're on duty whenever you drive or when you're:

- inspecting, servicing, repairing, conditioning or starting a commercial vehicle
- travelling as one of two drivers when you're not resting in the sleeper berth
- participating in the loading or unloading of a commercial vehicle
- inspecting or checking the load
- waiting for the vehicle or load to be checked at a customs office, weigh scale or by a peace officer
- waiting along the route because of a crash or other unanticipated event
- travelling as a passenger to a destination where you'll start driving — this qualifies as on-duty time when two conditions apply:
 1. the carrier requests you make the trip, and
 2. you didn't have eight consecutive hours of off-duty time immediately before you began your driving time
- performing any other work as a carrier or while employed by a carrier
- waiting for a commercial vehicle to be serviced, loaded or unloaded, when a carrier, who employs or otherwise engages you, asks you to do so.

fast fact

On-duty time doesn't include time spent on a ferry, unless you're working (for example, when a bus driver is selling tickets).

definition

Off-duty time is any time you're not on duty.

Off-duty time

It's important that you get enough rest every day. Off-duty regulations protect you and everyone else who shares the road with you.

- Off-duty time includes any time you spend in a sleeper berth in a commercial vehicle.
- All drivers must take a minimum of 10 hours off duty every day.
- Off-duty time other than the mandatory eight consecutive hours may be distributed throughout the day in blocks of 30 minutes or more.
- The total amount of off-duty time that you take in a day must include at least two hours of off-duty time that does not form part of a period of eight consecutive hours of off-duty time.
- All drivers must take 24 consecutive hours off duty every 14 days.

Day

A 'day' is a 24-hour period that begins at the hour designated by the carrier. Each 'day' is independent and there are certain on-duty, off-duty and driving limits for each day.

- A minimum of 10 hours of off-duty time must be taken every day.
- You're allowed to drive a maximum of 13 hours in a day.
- You're not allowed to drive after 14 hours on duty in a day.

Daily limits — a simple three-point check for compliance

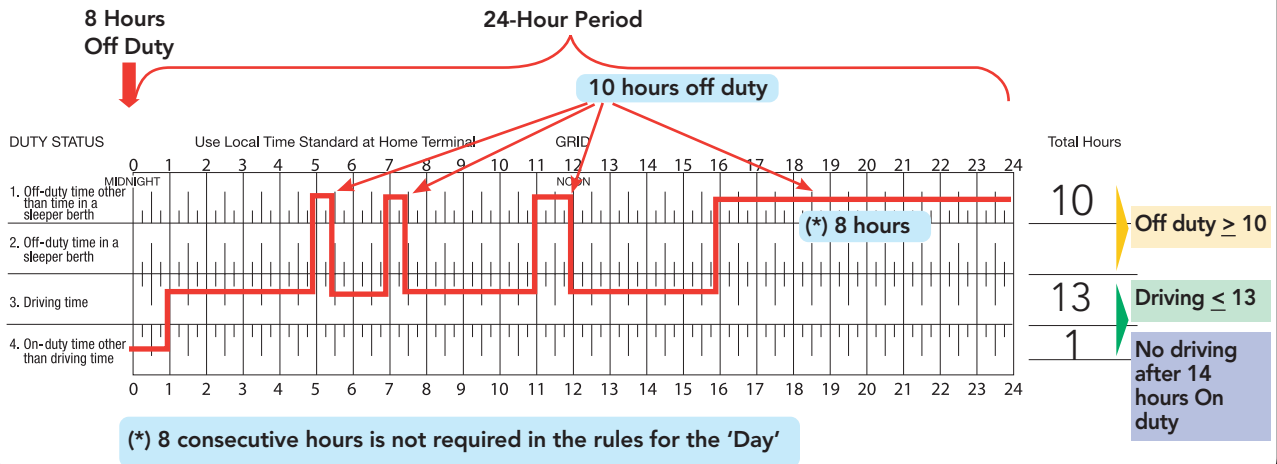

Work shift

A work shift is the elapsed time between two off-duty periods of at least eight consecutive hours. You're not permitted to drive after 16 hours of elapsed time until you take at least eight consecutive hours of off-duty time. Every off-duty period consisting of eight consecutive hours or more resets the work shift.

8 consecutive hours

8 consecutive hours

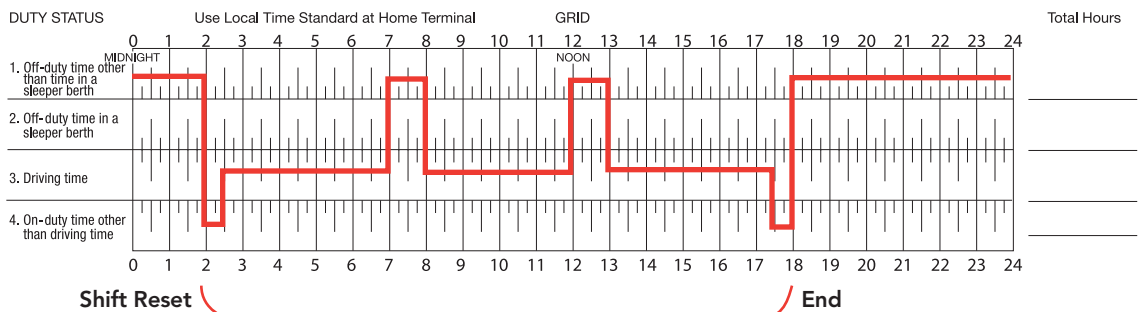

- No driving after 16 hours of elapse time
- Driving time ≤ 13 hours
- No driving after 14 hours on duty

fast fact

You can put in 14 hours of on-duty time without doing any driving at all.

Daily hours (cycles)

You must keep track of your time using one of two cycles. Each cycle has a maximum number of on-duty hours. You may choose one of two cycles:

Cycle 1 — Drivers working on this cycle must not drive after completing 70 on-duty hours in seven days.

fast fact

You can reset a cycle at any time by taking:

- 36 consecutive hours off duty to reset cycle 1
- 72 consecutive hours off duty to reset cycle 2.

Cycle 2 — Drivers working on this cycle must not drive after completing 120 hours in 14 days, and must take at least 24 consecutive hours off duty prior to accumulating 70 hours of on-duty time.

The start time remains the same throughout each cycle. You must “reset” a cycle to change the start time.

Deferring off-duty time

You may reduce your off-duty requirement of 10 hours by up to two hours providing:

- the two hours are not part of your eight consecutive off-duty hours
- the two hours are added to the eight consecutive off-duty hours taken off the next day, and
- you clearly indicate ‘Day 1’ and ‘Day 2’ on your logbook.

Driver has ‘deferred’ two hours from Day 1 to Day 2

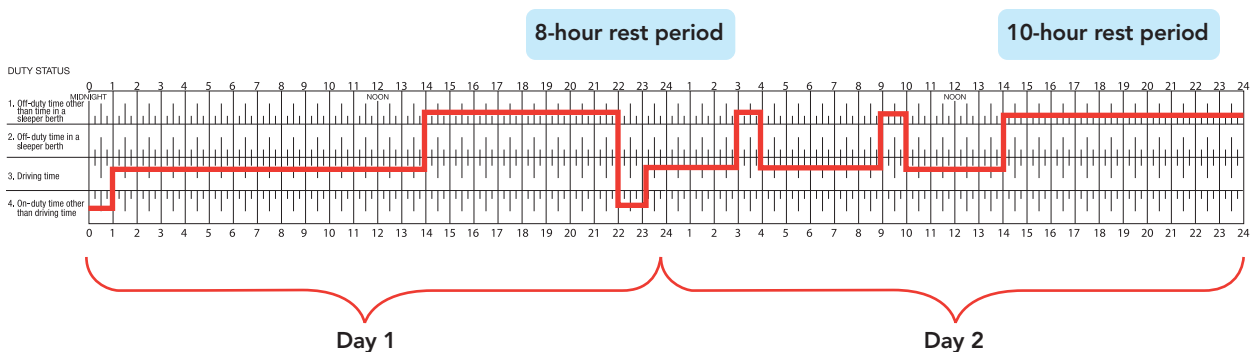

Notes:

- 1 The two hours ‘deferred’ from Day 1 are added to the eight-hour rest period on the following day (Day 2 — 1400–1600)
- 2 On Day 2 — Must still have the two ‘Off-Duty’ Hours that are not part of any mandatory eight-hour off-duty block (0300–0400) and (0900–1000).

Reset provision

You can reset a cycle at any time by taking:

- 36 consecutive hours off to reset Cycle 1
- 72 consecutive hours off to reset Cycle 2.

fast fact

A sleeper berth does not include the back seat of a bus or a reclining seat.

Sleeper berth

The same hours of service regulations for driving and on-duty time apply to drivers using sleeper berths.

Sleeper berth hours of service regulations for off-duty time are as follows:

Single drivers using a sleeper berth may split up their required off-duty time into two periods if:

- neither period is less than two hours, and
- the total off-duty time is at least 10 hours.

A logbook for a single driver using a sleeper berth is shown below.

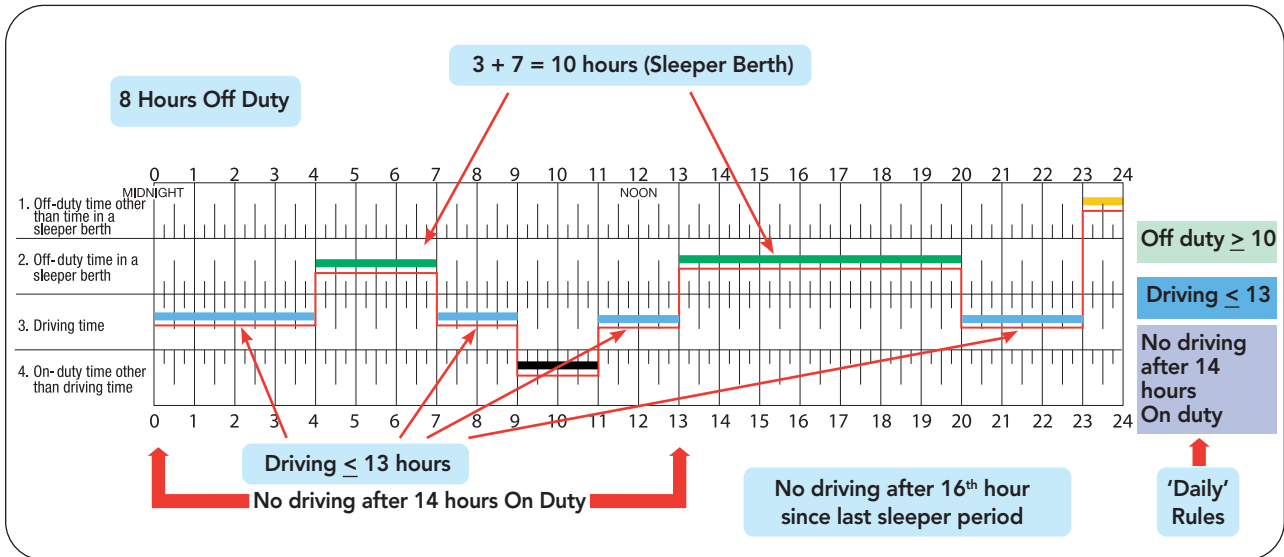

Team drivers using a sleeper berth can split their required off-duty time up into two periods if:

- neither period is less than four hours
- the two periods total at least eight hours, and
- the total off-duty time is at least 10 hours.

A logbook for a team driver using a sleeper berth is shown below.

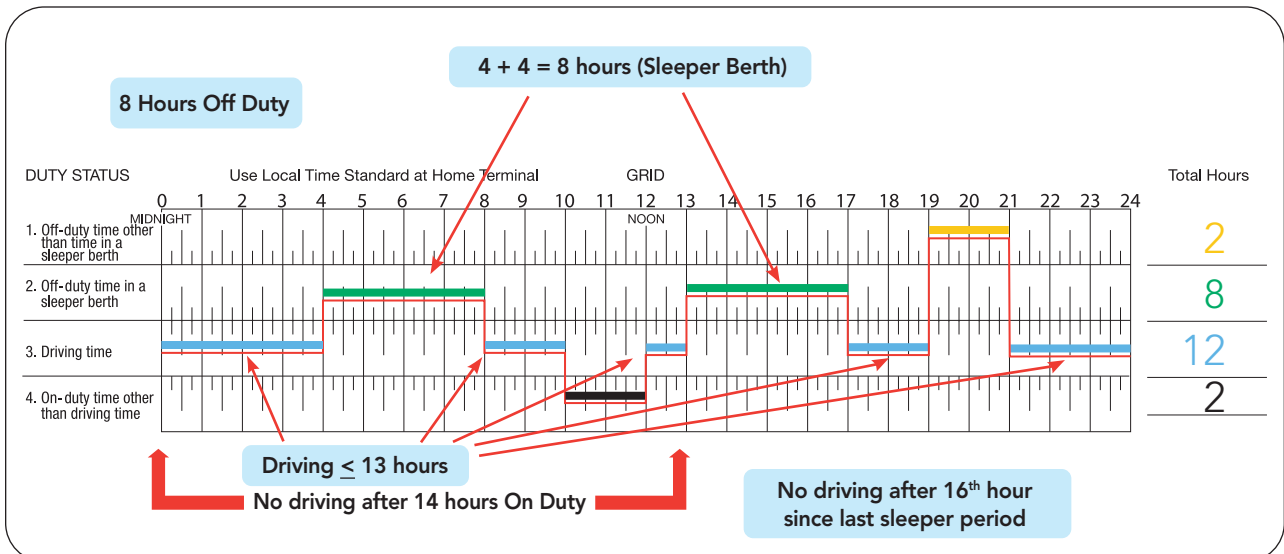

Personal use exemption

Driving a commercial vehicle for personal use is not considered to be on-duty time if:

- the vehicle's unloaded
- the vehicle's not towing a trailer
- the vehicle's driven a maximum of 75 km a day for personal use
- the odometer readings are recorded, and
- you're not subject to an out-of-service declaration.

Logbooks

Logbooks are used to record your hours of on-duty, driving and off-duty time. Logbooks must contain the following information:

- date
- start time if different from midnight
- name of driver in printed letters
- driver's signature
- name of the co-driver (if applicable)
- odometer reading at the beginning of the day
- odometer reading at the end of the day
- total distance driven by the driver during the day
- commercial vehicle licence plate number or vehicle unit number
- the cycle the driver is following
- name of every carrier the driver worked with, or for, during the day
- address of the home terminal and the principal place of business of each carrier the driver worked with, or for, during the day
- total number of hours spent in each duty status (on-duty time, off-duty time, driving time and off-duty sleeper berth time) — these totals must equal 24 hours
- total amount of time spent in one location doing on-duty work other than driving (this must be shown as a continuous line on the log)
- continuous line made by drawing through each time noted on the log page (the times noted must include every time the driver's duty status changed)
- name of the municipality or location on a highway, including the name of the jurisdiction, where each change in duty status took place
- declaration in the Remarks section of deferral of off-duty time, indicating 'Day 1' or 'Day 2'
- odometer reading at the beginning and end of personal use.

fast fact

A peace officer can order you out of service if you drive after reaching the maximum number of on-duty hours permitted for the cycle you are operating under. Only you are out of service, not the vehicle.

You must keep in your possession:

- a daily log that's updated to your last change in duty status
- copies of your daily log for your cycle — that is, the previous seven- or 14-day cycle you're using
- any supporting documents you've been issued during your trip.

You must submit your logbook and all supporting documents to your carrier within 20 days.

Peace officers, including police, commercial transport inspectors and motor vehicle inspectors, may ask to see your logbook. You must present your logbook and any supporting documents when asked. The documents may include:

- bills of lading
- shipping documents
- fuel receipts and accommodation receipts for expenses incurred along the route.

Sample logbook

MOTOR VEHICLE OPERATOR'S DAILY LOG		DATE		
Vehicle Numbers (Show all units)		Day	Month	Year
Carrier Name ABC CARRIERS INC.		01	01	2008
Home Terminal Address 1000 SHIPPING ST. VANCOUVER, B.C.		Odometer Finish 152029.5		
Principal Place of Business Address (if different from above)		Odometer Start 151575.0		
Cycle		Daily Deferral Day #		
1 <input checked="" type="checkbox"/> 2		Total Distance 454.5 km/ml		

DUTY STATUS	Use Local Time Standard at Home Terminal	Total Hours
Off Duty	<div style="display: flex; justify-content: space-between;"> MIDNIGHT NOON </div>	10
Sleeper Berth		13
Driving		1
On Duty		24

Remarks _____

Printed Name of Driver **J. Jones** Other Vehicle Operator _____

Signature of Driver *J. Jones*

Personal Use of Commercial Vehicle	
Start _____	End _____
Odometer _____	Odometer _____

Drivers operating within 160 km of home terminal

You aren't required to keep logbooks if:

- you operate a commercial vehicle within a radius of 160 km of the home terminal
- you return to the home terminal each day to begin a minimum of eight consecutive hours of off-duty time
- you're not driving under a permit issued under these regulations, and
- you maintain accurate and legible records for each day that:
 - include each duty status
 - state driving and on-duty time separately
 - indicate the cycle you're using
 - note if any off-duty time is deferred and indicate if it's 'Day 1' or 'Day 2'
 - record the odometer readings if you use the vehicle for personal use and
 - keep the records for a minimum of six months.

Other jurisdictions

Although the rules in most jurisdictions are similar, there are exceptions. Before entering another jurisdiction, be sure you know that jurisdiction's requirements.

Driving north of the 60th parallel

If you operate commercial vehicles in the Yukon or Northwest Territories or Nunavut:

- you may drive a maximum of 15 hours
- you may not drive after 18 hours of on duty
- must take at least eight consecutive hours of off duty after driving for 15 hours or 18 hours of on-duty time
- drivers may choose one of two cycles:
 - Cycle 1 — 80 hours of on-duty time in seven days
 - Cycle 2 — 120 hours of on-duty time in 14 days, and you must take 24 consecutive hours of off duty prior to accumulating 80 hours of on-duty time.

fast fact

As a B.C. driver, you may not operate a commercial vehicle in the U.S. if you have a history of epilepsy, if you have diabetes controlled by insulin or if you don't meet the U.S. hearing standards.

Driving into the U.S.

Canadian drivers must obey all U.S. regulations while operating in the U.S.:

- you may drive for 11 hours after 10 hours of off-duty time
- you may not drive beyond the 14th hour after coming on duty, following 10 hours off duty
- you may work a maximum of:
 - 60 hours of on-duty time in seven days, or
 - 70 hours of on-duty time in eight days, or
 - the on-duty cycle may be restarted after at least 34 consecutive hours off duty
- you will have to participate in a drug and alcohol testing program administered by your employer.

While the hours-of-service regulations are different in Canada and the U.S., the requirements for keeping a logbook are similar. You're responsible for learning and complying with the laws of each jurisdiction you travel through.

driving tip

More information on driving into the U.S. may be found at www.fmcsa.dot.gov/index.htm.

Be aware that other jurisdictions have different requirements for the maintenance of logbooks and the number of hours you may work each day.



Review questions

1. Why are hours of service regulations in place?
2. Are you permitted to record pulling off the road and taking a nap in a reclining seat of a commercial vehicle as sleeper berth time?
3. What's the maximum amount of driving hours permitted in a day?
4. How many consecutive hours of off-duty time must be taken every day?
5. What's the maximum amount of on-duty time in Cycle 1?
6. What's the maximum of on-duty time in Cycle 2?
7. When you're operating in Cycle 2, when must you take 24 consecutive hours of off-duty time?
8. How many consecutive hours of off-duty time must be taken to reset the cycle in Cycle 1?
9. How many consecutive hours of off-duty time must be taken to reset the cycle in Cycle 2?
10. How often does a driver have to take 24 consecutive hours of off-duty time, regardless of cycle?
11. When must you submit your logbooks to the carrier?
12. What are the consequences if you exceed your maximum on-duty hours and an enforcement officer stops you?

What you'll learn

After reading this chapter you'll be able to:

- identify the components of an air brake system
- explain how an s-cam foundation brake works
- describe what happens when one or more air brake system components fail
- explain how trailer brakes are applied.

Why air brakes?

Air brake systems:

- use a much greater force to apply the brakes than hydraulic braking systems do, which is needed to cope with the heavy loads of commercial vehicles
- are more tolerant to small leaks, which in a hydraulic system could result in brake failure (an air brake system includes a compressor to generate more compressed air as needed).
- are capable of stopping heavy commercial vehicles safely.

What's compressed air?

Air can be compressed (squeezed) into a much smaller space than it would normally occupy. The tires on a car are filled with compressed air to support the weight of a vehicle.

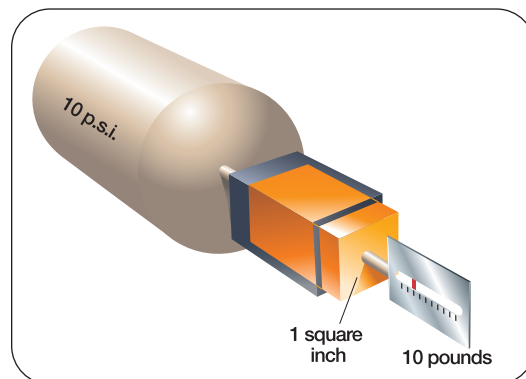

Squeezing air into a smaller space increases the air's resistance. This resistance creates pressure, which can be converted into mechanical force to apply the brakes. Air brakes generate more braking force than hydraulic brakes.

If a constant supply of compressed air were directed through a pipe that's one-inch square (see diagram on the previous page), and if a one-inch square plug were placed in the pipe, the compressed air would push against the plug. Holding a scale against the plug would register how many pounds of force the air was exerting against the plug.

If the scale registered 10 pounds, for example, then it could be said that the force was 10 pounds on the one square inch surface of the plug. This would be 10 p.s.i. or 68.9 kPa.

The more the air's compressed (that is, the greater the air pressure), the greater the force that would be exerted on the face of the plug.

Basic air brake components

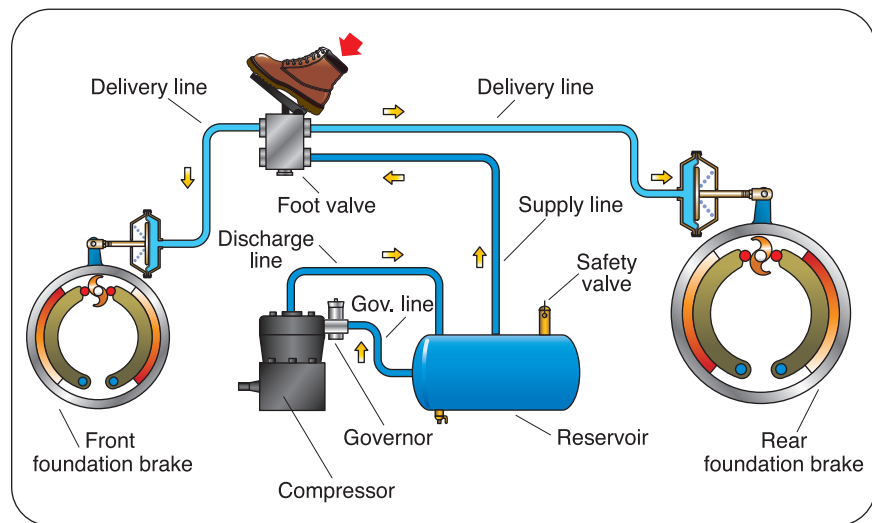

The basic components of a simple air brake system showing the brakes applied.

This diagram shows the components that are used to make the simplest possible air brake system:

- A **compressor** to pump air, with a **governor** to control the compressor.
- **Air lines** to allow the pressurized air to flow between the air brake system components.
- A **reservoir** to store the compressed air.
- A **brake pedal** (usually called a **foot valve**) to apply the brakes by directing compressed air from the reservoir to the brakes.
- **Foundation brakes**, including brake chambers, slack adjusters, brake linings and drums or rotors, to transfer the force generated by the compressed air through a mechanical linkage to apply the brakes.

Force multipliers

The force generated at the wheel to stop is a lot more than the force you apply when pushing down on the brake pedal.

The driver is using a tool to gain leverage to measure the brake chamber pushrod travel.

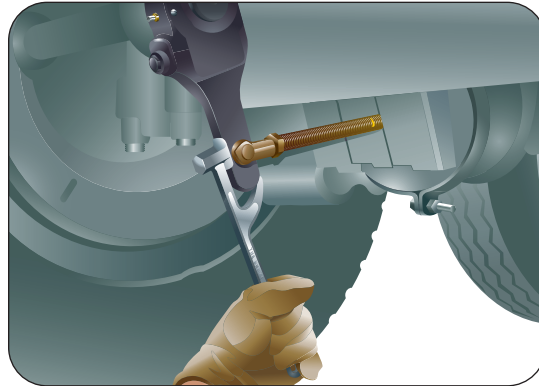

In this diagram, the driver is pulling on an air brake slack adjuster to measure if the brake is within adjustment tolerance.

The slack adjuster, besides adjusting for brake wear, acts as a lever. Leverage is a form of force multiplication.

Trucks and buses are much heavier than cars, so they need even more mechanical advantage.

Air brake chamber components

Diagram of a typical clamp-type air brake chamber.

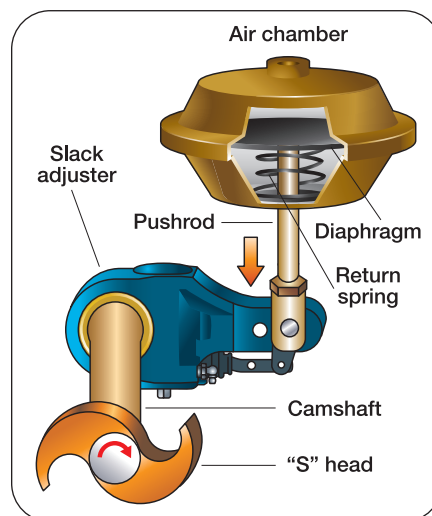

The diagram above shows the most common device used to apply truck air brakes — the **air brake chamber**. It converts the force of compressed air into a strong mechanical force through the pushrod and slack adjuster.

The air brake chamber consists of a flexible diaphragm clamped between two steel housings. The diaphragm construction is similar to a tire sidewall, consisting of a reinforced fabric core with a rubber coating. Other main parts are the pushrod and plate assembly, and a return spring.

Leverage and air pressure

Air chambers are very powerful. A typical type 30 chamber, if applied with air pressure at 100 p.s.i. (690 kPa), develops a pushrod force of 3,000 pounds. This force is then applied to move the lever (the slack adjuster) to apply the brakes.

Through force multiplication, 100 p.s.i. (690 kPa) of air pressure produces a pushrod force of 3,000 pounds.

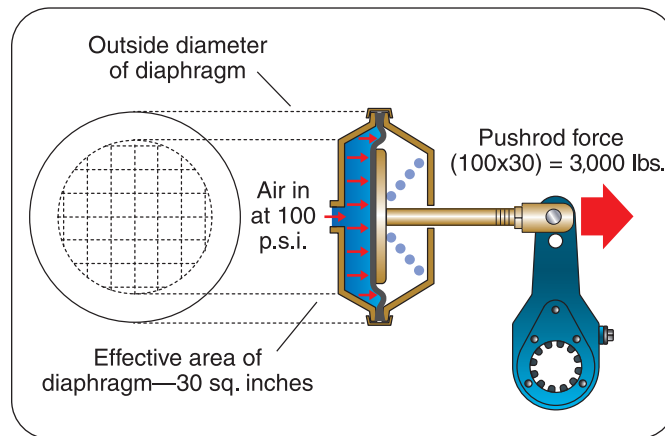

Long stroke and regular stroke brake chambers

Many new air brake systems are equipped with long stroke brake chambers. As the name implies, a long stroke chamber design has a longer pushrod stroke than the pushrod of a standard brake chamber.

Long stroke brake chambers can be identified by their square-shaped inlet ports and/or trapezoid-shaped name tag on a clamp bolt.

Air brake chamber — air pressure applied

The force of the compressed air against the diaphragm causes the pushrod to extend out of the brake chamber.

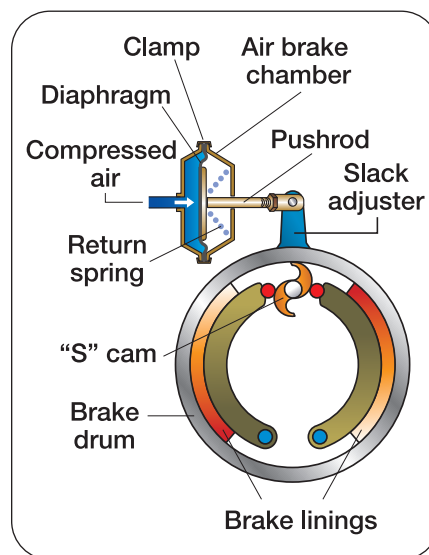

This diagram shows how air under pressure is admitted to one side of the diaphragm, causing it to inflate. As it inflates, the diaphragm pushes against the pushrod, plate assembly and the return spring, causing them to move. Note the position of the slack adjuster — it's now at about a 90-degree angle to the pushrod.

The amount of pushrod force is governed by the air pressure (in pounds per square inch) and the effective surface area of the diaphragm (in square inches). The pushrod force is exerted against the brake mechanism, causing the brakes to apply.

The most common size air chamber used on truck drive axles and trailer axles is a regular Type 30 clamp type chamber with 30 square inches of effective diaphragm area.

Air chambers are very powerful. The common Type 30 regular chamber (shown in the diagram on the previous page) if applied with air pressure of 100 p.s.i. (690 kPa) develops a pushrod force of 3,000 pounds.

Air chambers are made in a number of sizes, ranging from Type 9 (with nine square inches of effective diaphragm area) to Type 36 (with 36 square inches of effective diaphragm area). The range of sizes allows the truck engineer to match air chamber force with axle capacity so that no axle is under- or over-braked.

Even though truck air brake system pressures are 100 p.s.i. (690 kPa) and above, much lower air application pressure, usually less than 20 p.s.i. (138 kPa), is used to make normal stops.

definition

Foundation brake refers to the mechanical parts of the brake system inside the wheel.

Foundation brakes: s-cam type

The brake assembly at each wheel is generally called the **foundation brake**. The assembly consists of the brake parts around the wheel that are operated by the air brake system, including the brake chamber. The most popular type of foundation brake is the s-cam drum brake.

When air pressure is applied to the brake chamber diaphragm, it causes the pushrod to move against the slack adjuster arm which rotates the s-cam to apply the brakes.

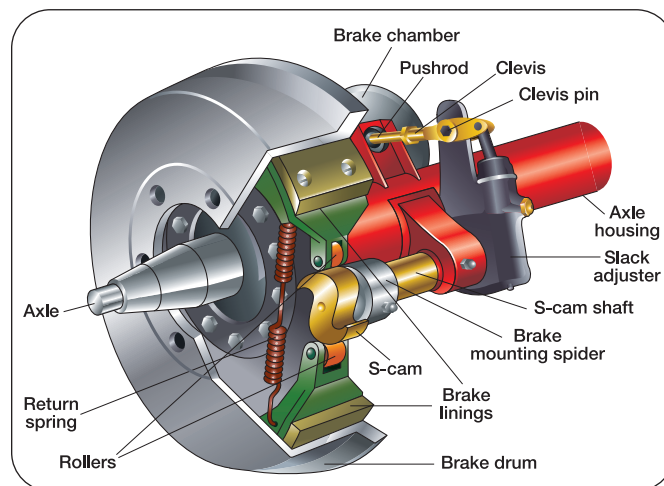

This diagram shows the main components used in the s-cam drum foundation brake. The air brake chamber pushrod is connected to a lever arm called a **slack adjuster**. The slack adjuster is attached to a camshaft with an s-shaped head called an **s-cam**. Air pressure applied to the chamber causes the pushrod to move forward, causing the slack adjuster to rotate the s-cam. This causes the **brake linings** to press against the **brake drum**, causing friction, which causes the wheel to decelerate, stopping the vehicle.

The slack adjuster is also the way to adjust the brakes to compensate for brake lining and brake drum wear. Brake adjustment is important and is covered in **chapter 9, air brake adjustment**.

Brake shoe **return springs** keep the brake linings away from the drum when the air pressure is released from the air chamber.

The picture on the left shows the brake linings mounted on the axle housing. The brake drum on the right is mounted on the wheel and rotates with it.

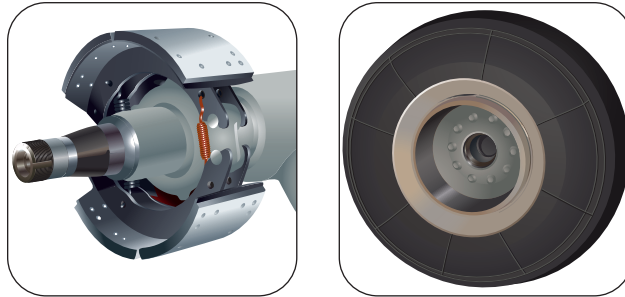

Compressor

The first requirement of an air brake system is a way to compress air and store it in reservoirs (tanks) so that it's available for instant use.

The source of the compressed air is the **compressor**, which takes in air from the atmosphere and compresses (pressurizes) it. The compressed air is then pumped through an air line to a supply reservoir.

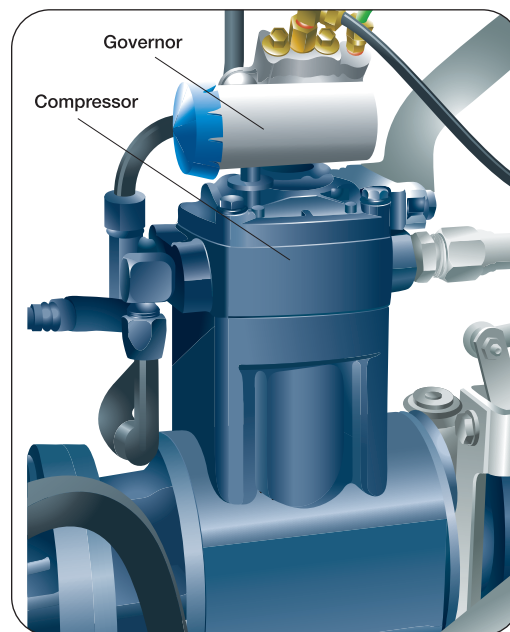

A gear-driven compressor and governor.

driving tip

Check belt tension by pressing down on the belt midway between the pulleys. If you can press it in more than double the width of the belt, the tension needs to be adjusted.

The compressor is mounted on the engine of the bus or truck. On most new engines, the compressor is mounted on the side of the engine and driven by gears. A belt, like a fan belt, drives some compressors. As long as the engine is running, the compressor will be running.

All trucks use piston-type air compressors. They may have one, two or four cylinders depending on the vehicle's volume demands.

When air is compressed, its temperature rises. With a truck air compressor operating at a pressure of 120 p.s.i. (827 kPa), the air temperature as it leaves the compressor is over 204° C (400° F).

To prevent the compressor from overheating, two types of cooling systems are used. The most common method on heavy trucks is to circulate engine coolant through the compressor, while some compressors on lighter units may be air-cooled.

Oil lubricates the moving parts of the compressor, just like oil is used to lubricate the moving parts of a car's engine. Oil also helps to cool the compressor. The compressor is usually lubricated from the same oil as the engine of the truck or bus, though some compressors have their own oil supply. It's important to check that there is sufficient oil supply.

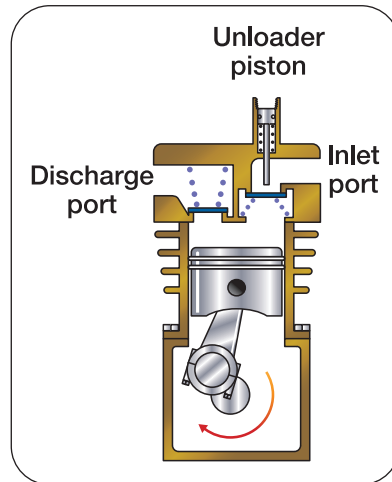

Diagram of an air compressor.

Since the compressor pumps air, it needs a supply of clean air to work properly. Air from the atmosphere supplies both the truck engine and the compressor. An air filter is used to keep this supply clean. The air filter should be checked regularly to make sure it is not clogged.

A piston-type compressor operates on a similar principle to that of the intake and compression strokes of a typical car engine.

Intake stroke

As the piston moves down in the cylinder, it creates a lower pressure (vacuum) within the cylinder than the atmospheric pressure outside the compressor. With the inlet valve open, air is then drawn into the cylinder to fill the vacuum.

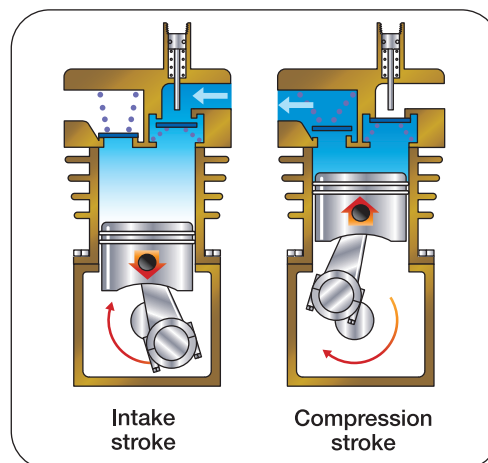

Air enters the compressor cylinder on the intake stroke. On the compression stroke, the inlet valve is closed and the discharge valve is open to feed the compressed air toward the air reservoir.

fast fact

Many current air brake systems operate with a maximum pressure of approximately 125 p.s.i. (862 kPa).

fast fact

Vehicle safety standards require that the governor must be set to allow the compressor to resume compressing air if the air pressure drops below 80 p.s.i. (552 kPa).

fast fact

The compressor must be capable of building pressure in the reservoirs from 50 p.s.i. to 90 p.s.i. within three minutes at a fast idle (1,000 – 1,200 r.p.m.).

The governor causes the unloader piston in the compressor to open the inlet valve. In this stage, the compressor is said to be governor unloaded.

Compression stroke

When the piston reaches the bottom of the cylinder, it begins to rise. The inlet valve closes, causing the air in the cylinder to compress. As the piston nears the top of the stroke, the discharge valve opens, and the pressurized air is forced past the valve and into the discharge line leading to the reservoir.

Governor

The compressor is capable of compressing air to over 500 p.s.i. (3,448 kPa). This is far higher than is needed to operate an air brake system. Most current air brake systems operate with a maximum pressure of 125 p.s.i. (862 kPa).

There needs to be a way to stop compressing air once a certain air pressure has been reached. And, if the air pressure in the tanks drops below a certain level (such as after a series of brake applications), there needs to be a way to start compressing air again.

This is the job of the **governor**. When enough pressure has been built up, the governor causes the compressor to go into an “unloading” stage.

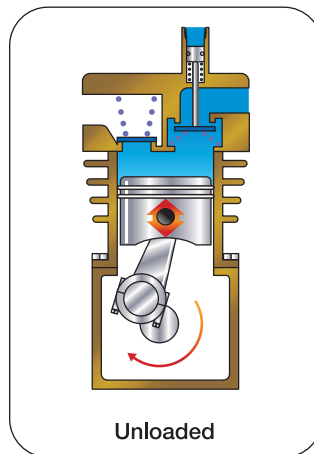

Governors are usually set to unload the compressor (stop the compressor from pumping air) when the air pressure reaches about 125 p.s.i. Although the maximum pressure on different vehicles may vary between 105 and 135 p.s.i. (724 and 931 kPa), the range between minimum and maximum pressure should be approximately 20 p.s.i. (138 kPa).

For example, if the maximum air pressure was 125 p.s.i., the governor would restart the compressor if air pressure in the reservoirs dropped to 105 p.s.i. (applying the brakes several times would likely cause the air pressure to drop to this level). At any rate, the governor must restart the compressor if the air pressure drops below 80 to 85 p.s.i. (552 to 586 kPa).

fast fact

The safety valve is sometimes called a pop-off valve.

Air reservoir, showing safety valve on top and drain cock on the bottom.

driving tip

When you're draining reservoirs, allow plenty of time for the air to completely drain.

warning!

Compressed air can be dangerous if it escapes, particularly to eyes and to ears.

Stay out of the direct path of compressed air when draining the reservoirs.

Reservoirs

Steel tanks (known as **reservoirs**) are used to store the compressed air from the compressor.

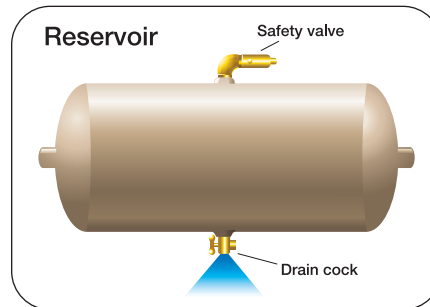

A **safety valve** on the first reservoir protects the reservoirs from being over-pressurized and bursting if the governor fails to unload the compressor. The safety valve consists of a spring-loaded ball to allow reservoir air to exhaust into the atmosphere. The valve's pressure setting is determined by the force of the spring. Safety valves are normally set to vent the excess pressure at approximately 150 p.s.i. (1,034 kPa).

If the safety valve has to relieve the pressure, the governor or compressor needs service or repair. Only a qualified mechanic should do this.

The air that's delivered from the compressor usually contains some water vapour that condenses into liquid water. This is why the supply reservoir is often called the **wet tank**. Most compressors also pass a small amount of oil and carbon particles. The oil and any other contaminants mix with the water, making a grey sludge.

If allowed to accumulate, this sludge would enter other components of the braking system. Too much water in the system causes trouble with valves and other parts. In winter, water in the system may freeze, causing malfunction of valves or brake chambers.

To prevent this sludge from contaminating the air valves in the system, **drain valves** (also known as **drain cocks**) are installed in all reservoirs. Draining the reservoirs can prevent this sludge build up. Most manufacturers recommend that you drain reservoirs daily.

Foot valve

Pressing on the brake pedal (called the foot valve treadle) applies the air brakes, just like stepping on the brake pedal applies the brakes in a car.

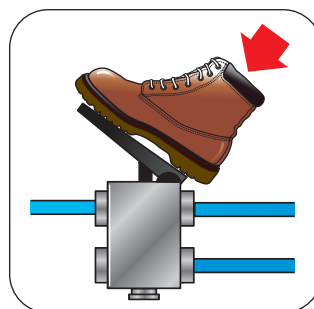

A foot brake valve.

fast fact

The maximum brake application will not exceed the pressure in the reservoirs.

For example, if reservoir pressure is 80 p.s.i. (552 kPa), the maximum brake application you could make wouldn't exceed 80 p.s.i.

The treadle (pedal) of a foot valve has a springy feel that is quite different from the feel of a hydraulic brake pedal of a car. For one thing, you really don't have to press harder on a foot valve to apply more braking force — you simply have to press it down a bit farther. If the foot valve is held in one position, the air pressure delivered to the brake system will remain constant.

Releasing the foot valve allows the application air to be exhausted through the assembly's exhaust ports to the atmosphere.

In effect, it is a foot-controlled pressure regulator. It's the device that allows you to select any application pressure needed to make a gentle, or a very rapid stop.

A unique feature of a foot control valve is the ability to maintain the application pressure that you've chosen, even if there are small leaks downstream from the foot valve. You need only to maintain the treadle position and the foot valve will momentarily open, replenish any air that has been lost, and then close — all automatically.

How air brakes work

Brakes applied

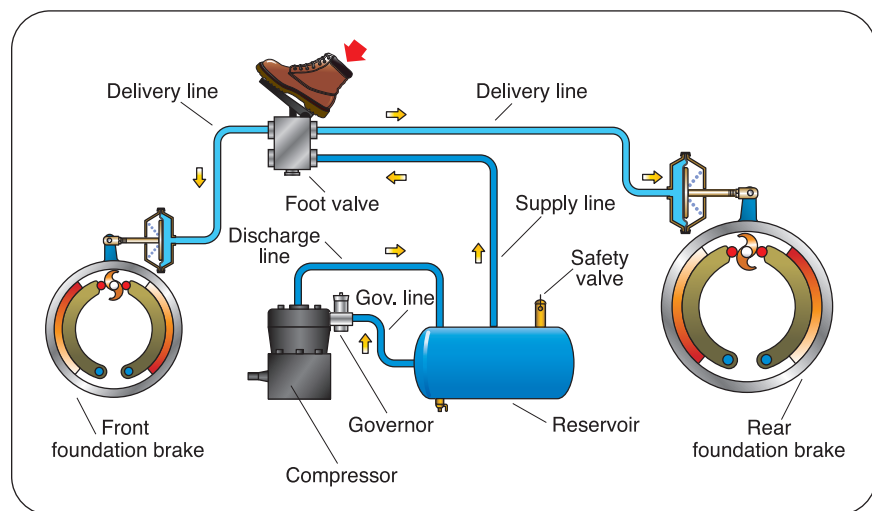

The driver has depressed the foot valve to apply the brakes.

In this simplified diagram, air at full system pressure is indicated by the dark shading in the line connecting the supply reservoir to the foot valve.

The driver is making a brake application. This can be seen by the light shading in the air lines connecting the foot valve to the air chambers. Arrows show the direction of air flow.

The air chambers are pressurized and the brake linings have contacted the brake drums, slowing the vehicle.

Brakes released

When the driver releases the foot valve, air pressure in the brake chambers exhausts into the atmosphere.

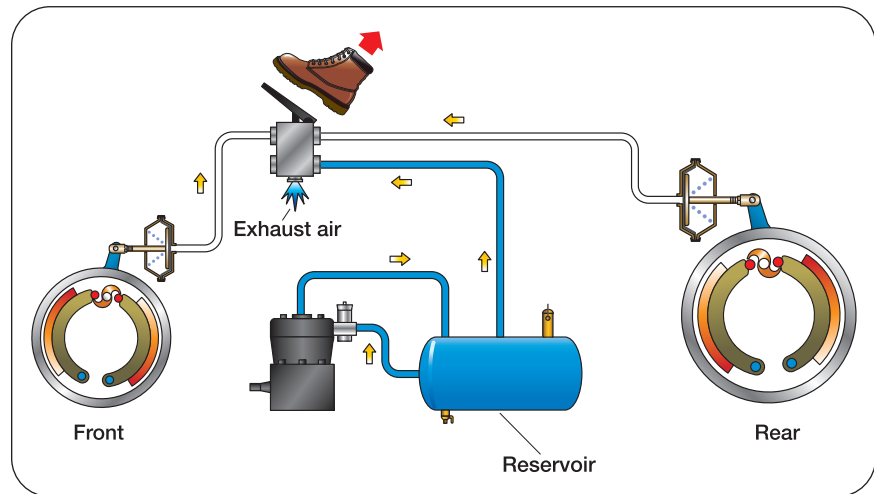

In this simplified diagram, the driver's foot is off the brake pedal, allowing the brakes to release. This action has caused an exhaust port in the bottom of the foot valve to open, allowing the air that was applied to the brake chambers to escape. Note the burst of exhaust air below the foot valve.

The return springs in the air chambers have returned the pushrod assembly to the released position, and the slack adjusters and s-cams have rotated to their released position.

Brake shoe return springs (not shown) have retracted the brake linings away from the brake drums.

Dual air brake systems

Dual air brake systems have been in use since the mid-1970s.

A dual air brake system with the brakes applied.

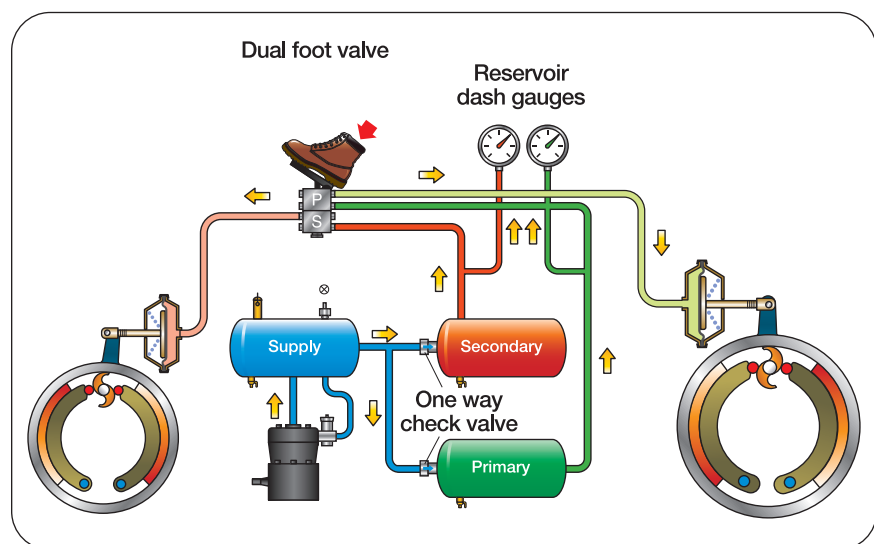

fast fact

Cars have had dual braking systems since 1968 to reduce the chance of a total brake failure.

The device that made dual systems possible is the **dual foot valve**. It's actually two control valves operated by a single pedal. This allows the brake system to be divided into two completely independent sections. Each section has its own supply, delivery and exhaust ports.

The two sections of the dual foot valve are the **primary** and **secondary**. The primary section is located closest to the pedal, and in many systems operates the drive axle brakes. The secondary usually operates the steering axle brakes.

When the driver applies the brakes, both sections of the dual foot valve are activated. Air from the primary tank is applied to the rear axle brakes and air from the secondary tank is applied to the front axle brakes.

Most dual systems use three reservoirs: a supply reservoir and two service reservoirs, one for each section of the dual system. Each service reservoir is filled through a one-way check valve, and there are two reservoir pressure gauges, one for each service reservoir.

Even if one or the other system totally fails, the driver is able to make a controlled stop using only the foot valve, although maximum braking power will be reduced.

There are other ways of splitting a dual air brake system. However it's divided, if one of the systems fail, the driver is still able to make a controlled stop.

Note the change in terminology for the reservoirs. The first reservoir (wet tank) is called the **supply reservoir**. The two service reservoirs are called the **primary reservoir** and **secondary reservoir**, indicating the section of the dual foot valve that they supply.

Some dual systems have the low-air warning device connected to the supply reservoir as shown, while others have two separate connections, one located on each service reservoir.

Components of a dual air brake system

Supply, primary and secondary reservoirs

The compressed air from the compressor contains several contaminants including water vapour, oil mist and carbon particles. Most contaminants settle in the supply reservoir. Primary and secondary reservoirs have been added so that all the air brake components, with the exception of the governor valve, are supplied with cleaner air.

One-way check valve

One-way check valves allow air to flow from the supply reservoir to the primary and secondary reservoirs. As the name implies, a one-way check valve allows air to flow in one direction only.

This is so the air supply in the primary and secondary reservoirs wouldn't flow backward and be lost if there's a failure in the air compressor, compressor discharge line, or supply reservoir.

fast fact

Some reservoirs have more than one compartment (and more than one drain cock).

Reservoir pressure gauges

All air brake-equipped vehicles have at least one **air pressure gauge** on the instrument panel to indicate the air pressure in the service reservoir system.

The air pressure gauge on the left has a single needle. The air pressure gauge on the right has two needles — one indicating pressure in the primary reservoir, the other showing pressure in the secondary reservoir. The gauge on the left shows pressure in p.s.i. The gauge on the right shows both p.s.i. and kPa.



driving tip

Check gauges frequently to make sure there's enough air pressure to apply the brakes.

Rather than having two separate reservoir gauges, many vehicles have a single gauge with two needles, indicating the pressure in the primary and secondary reservoirs.

Many vehicles also have a gauge to indicate how much air pressure is being applied when the foot valve is depressed.

The reservoir pressure gauge is mounted in the dashboard so you can monitor the status of the air brake system while driving and during a pre-trip inspection.

Low-air warning device

All vehicles equipped with air brakes must have a warning device to indicate if the air pressure in the system drops to a dangerous level. This could occur if there's an air leak, or if you apply the brakes repeatedly and have used up the air supply more rapidly than the compressor can replenish it.

Many vehicles have two low-air warning devices — a warning indicator light on the dashboard and a buzzer.



The **low-air warning device** must come on when air pressure drops below 60 p.s.i. (414 kPa).

fast fact

The low-air warning device must activate when air pressure is less than 60 p.s.i. (414 kPa).

driving tip

If the low-air warning comes on, pull over and stop. Do not go further until you find out why the low-air warning came on and determine that the air brake system is safe.

A wig-wag.

A typical low-air warning device is a warning light on the dashboard. There may also be a buzzer.

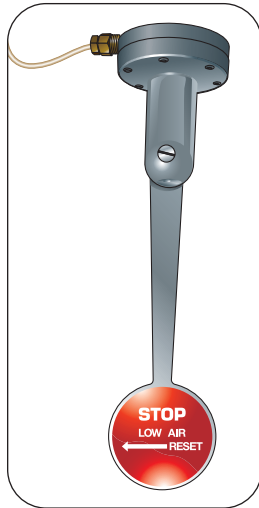

Some older vehicles are equipped with a low-air warning device near the top of the windshield that drops into the driver's view when air pressure drops below approximately 60 p.s.i. This type of warning device is known as a **wig-wag**.

Some wig-wags automatically retract when air pressure rises above the warning level of 60 p.s.i.; others need to be manually pushed up to the "out of view" position after the air pressure has risen above the warning level.

When a low-air warning device activates, stop the vehicle and find the cause of the air loss. The air pressure remaining in the system (approximately 60 p.s.i.) will be enough to stop the vehicle if you act promptly.

Quick release valve

In the previous diagram, when the driver released the brakes, all the air contained in the air lines and in the air chambers was vented through the foot valve exhaust port. Because of the distance that the exhaust air has to travel, there can be a considerable lag time for the brakes to release.

This is where the **quick release valve** comes in.

A quick release valve allows the brakes to release quickly and fully, by allowing the pressurized air to exhaust near the brake chambers. In this diagram a quick release valve is placed close to the front brake chambers between the foot valve and the air chambers.

When the brakes are applied, air from the foot valve flows through the quick release valve to the chambers in the normal way.

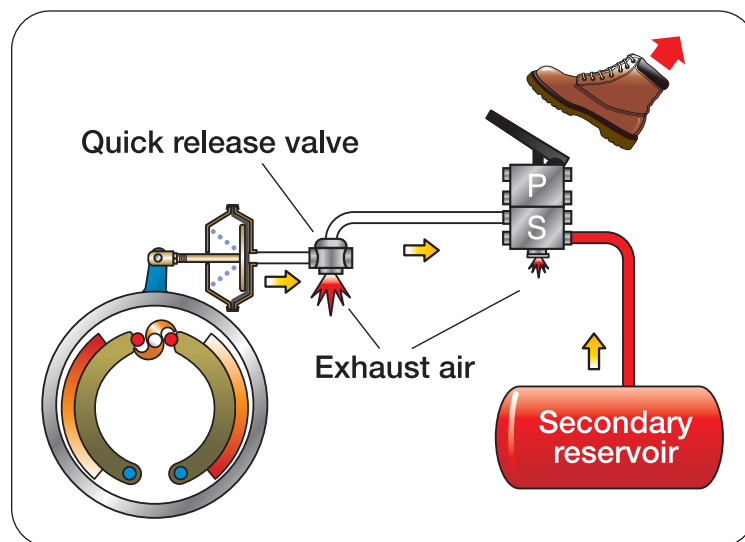

A **quick release** valve has been installed between the front brake chambers and the **foot valve**.

When the driver releases the foot valve, only the air in the line between the foot valve and the quick release valve is vented at the foot valve exhaust port. The larger volume of air contained in the air chambers is vented at the exhaust port of the quick release valve.

Note the difference in the air bursts at the foot valve and at the quick release valve — there's a much bigger burst of exhausting air at the quick release valve.

Quick release valves may be found in a number of places in an air brake system, including front brakes, rear brakes, spring parking brakes and any other place that the rapid exhausting of air is required.

Relay valve

A **relay valve** has been installed between the reservoir and the rear brake chambers.

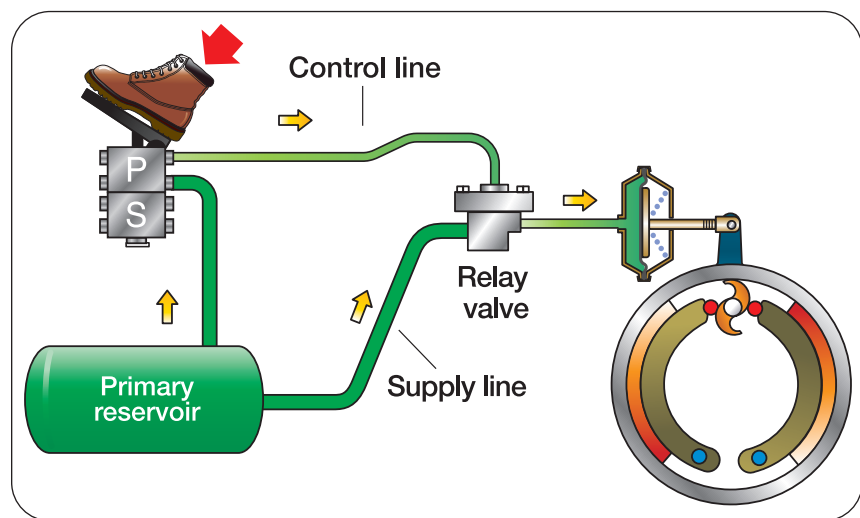

Relay valves are used to reduce the lag time when the brakes are applied, and when they're released. They're remote-controlled air valves that respond to a control signal from the foot valve. They're usually mounted on a frame rail close to the air chambers that they're to operate.

Relay valves are supplied with air directly from the primary or secondary reservoirs through a large diameter air line (shown as the **supply line** in the diagram) so that there's a high volume of air available for rapid delivery to the air chambers.

The pressure of the reservoir air delivered in this way will be the same as the control pressure delivered by the foot valve. If you make a 20 p.s.i. (138 kPa) brake application, approximately 20 p.s.i. of air pressure would be directed to the rear brake chambers through the relay valve.

When the driver releases the foot valve, only the air in the control line is vented at the foot valve exhaust port. The volume of air contained in the air chambers is vented through an exhaust port built into the relay valve.

Relay valves are designed to handle the volume requirements of two or four air chambers. They're primarily found on rear axle brakes, but relay valves are sometimes found on steering axle brakes or wherever there's a need to apply and release air rapidly.

For simplicity, quick release valves and relay valves are not shown in the following diagrams because they don't change the basic concept of an air brake system, but serve only to speed up the release of the brakes, if needed.

Dual system with primary system failure

This diagram shows the worst-case failure where a line rupture has caused a total loss of pressure in the primary reservoir.

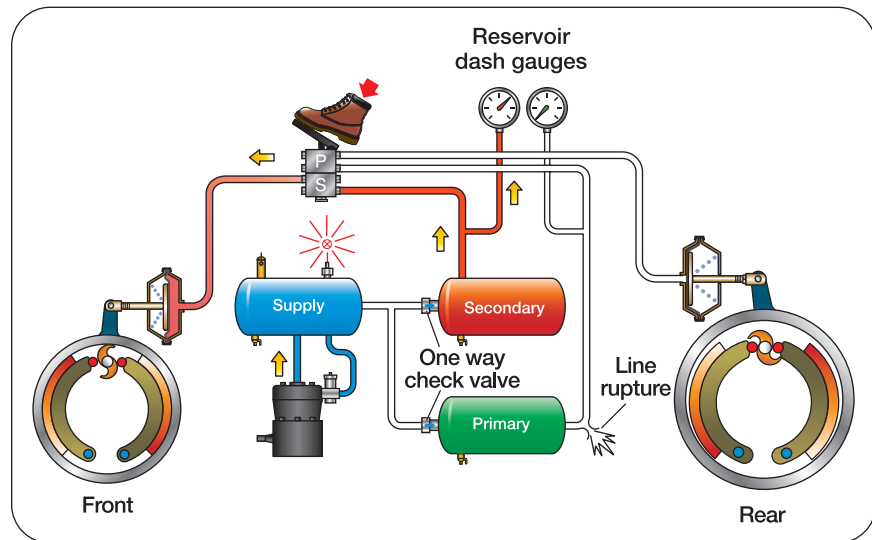

Despite a loss of primary reservoir pressure, the front (secondary) brakes will still operate.

Air pressure in the secondary reservoir has been protected by the one-way check valve. The low-air warning system must activate when pressure in any reservoir falls below 60 p.s.i. (414 kPa) to alert the driver to the problem. In many systems, the warning will come on at pressure above 60 p.s.i.

When you apply the brakes, you'll be able to make a controlled stop, but only the steering axle brakes will apply. Stopping distances will be longer because the braking force will be reduced.

If the failure had been in the secondary system, braking on the rear axle would've been maintained, but the steering axle brakes would not operate.

The compressor will continue to pump air, but all of its output will take the path of least resistance and be vented at the line rupture.

If the low-air warning system activates at any time, **stop immediately** and don't proceed until a repair has been made.

Parking brakes

While air pressure does an excellent job in helping stop a vehicle by applying the foundation brakes, it's totally unreliable (and illegal) for parking. If you park a vehicle using only the air brakes, any leaks in the system, or any failure in a hose, diaphragm, or air valve would result in loss of air pressure and a possible rollaway collision.

Regulations for parking brakes require that the parking force must be maintained by mechanical means and be unaffected by loss of air pressure.

The most common type of parking brake in an air brake system is the **spring parking brake**. The second type is known as a **safety actuator** and is usually found only on some highway coaches and intercity buses.

Spring parking brakes

Most spring parking brakes consist of an additional chamber attached to the rear of a service brake chamber. The added chamber contains a powerful coil spring arranged so that the spring force can be applied to the brakes through the normal service chamber pushrod.

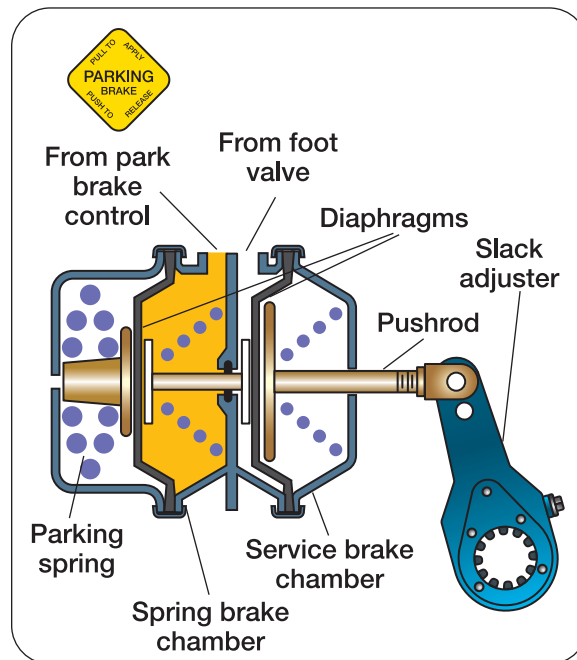

A spring parking brake chamber attached to a service brake chamber. The brakes are off.

fast fact

The spring parking brakes will apply if air pressure falls beneath a certain level, but their effectiveness in stopping the vehicle or holding a parked vehicle depends on how well the brakes have been kept in adjustment.

This concrete mixer has spring brakes on its tandem rear axles only — not on the twin steering axles, nor on the booster axle at the rear.

This diagram shows the main components of a typical combination spring and service brake chamber.

Spring parking brakes are mounted on the rear axles only — not on steering axles. The service brake chamber contains the normal pushrod, diaphragm and return spring. The spring parking brake section is mounted behind the service brake chamber.

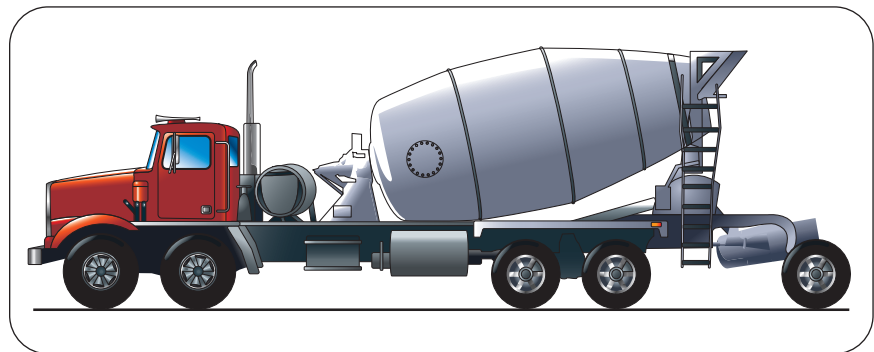

warning!

The spring in a spring parking brake is very powerful. If the spring were ever to break out of the chamber, it could cause serious damage to any objects or persons in its way.

Keep away from a spring parking brake chamber that shows any sign of damage, such as dents or cracks anywhere in the housing.

driving tip

In some systems, spring parking brakes will gradually apply as air pressure goes down, rather than apply all at once. In some of these systems, they may begin to apply at 90 p.s.i. or higher.

Air pressure in the spring parking brake chamber keeps the spring parking brake off. There's no air pressure in the service brake chamber.

The spring parking brake chamber contains a second diaphragm, a large coil spring, and an intermediate pushrod that transmits the force of the coil spring to the service brake pushrod when the spring parking brake is applied. The coil spring in most spring parking brake chambers can exert a force of between 1,500 and 2,000 pounds.

When you make a regular foot brake application, air pressure is applied against the diaphragm in a service brake chamber, causing the diaphragm to inflate, pushing the pushrod out against the slack adjuster to apply the foundation brakes.

Spring parking brakes work in the opposite way. These brakes are applied and remain applied by mechanical spring pressure, not by air pressure. If air pressure falls beneath the amount needed to keep the spring compressed, the spring pushes against the pushrod in the service brake chamber, pushing the pushrod out against the slack adjuster to apply the foundation brakes (because the parking brake chambers are piggy-backed onto the service brake chambers and operate the foundation brakes through the same linkage).

Spring parking brake assemblies should only be serviced by qualified personnel. The spring in a spring parking brake chamber is under extreme pressure and could cause serious injury.

Applying and releasing spring parking brakes

There are several ways to apply and release spring brakes.

- Normally they're applied and released by using the parking brake control valve on the dashboard.
- If the air pressure in the system falls below approximately 60 p.s.i., the spring brakes may begin to drag, and at 20 to 45 p.s.i. (138 to 310 kPa) may automatically fully apply.

Spring parking brake — released

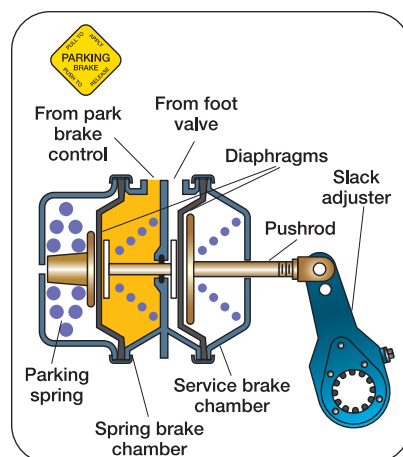

This diagram shows a spring parking brake chamber in the released position. The service brake is also in the released position.

Air at reservoir pressure has been supplied to the spring parking brake section. The parking brake diaphragm has inflated, compressing the main spring. The spring parking brakes are now released.

A **parking brake control valve** (usually a yellow button) is mounted on the dashboard. In most cases, pushing this valve in allows air pressure to flow to the spring parking brake chambers, causing these spring parking brakes to release. Pulling this valve out exhausts the air pressure against the spring parking brake chamber, causing these brakes to apply. Instructions are usually imprinted on the button.

While the push-pull parking brake control is the most common, some systems use a switch, usually set so that flipping it in one direction applies the spring parking brakes and flipping it in the other direction releases them.



A parking brake control valve.

Spring parking brake — service brake applied

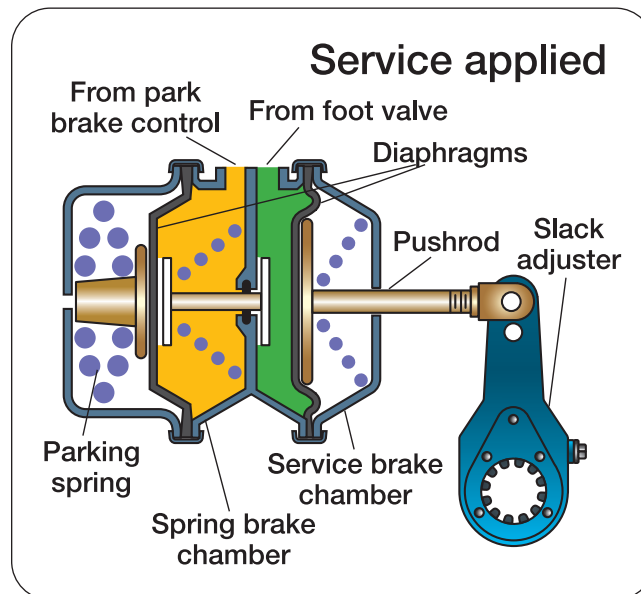

The driver has applied the service brake. Air pressure in the spring parking brake chamber keeps the spring parking brakes off.

The driver has applied the foot valve, delivering air to the service brake port, inflating the service brake diaphragm.

Spring parking brake — spring brake applied

The driver has applied the spring parking brake. There is no air pressure in either the spring parking brake chamber or the service brake chamber.

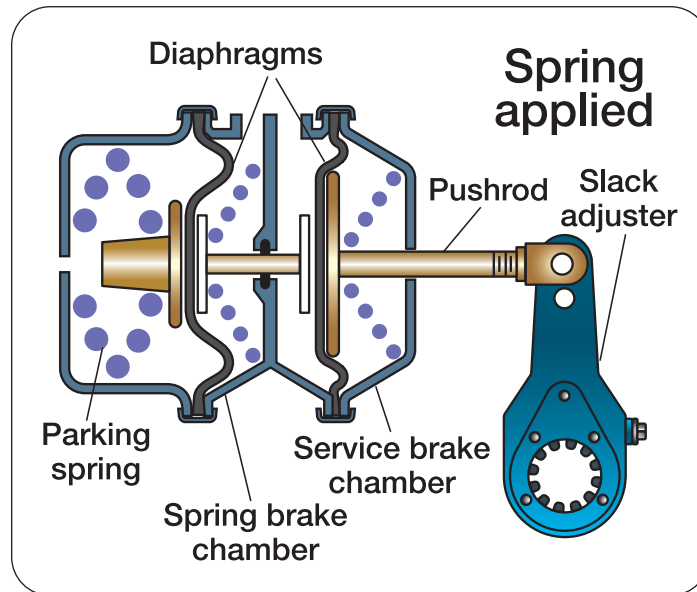

The driver has placed the parking brake control valve in the “park” position. This has caused the air from the spring parking brake section to be exhausted.

The force of the coil spring has been transmitted to the intermediate pushrod, which in turn has pushed against the service brake diaphragm, pushrod, and slack adjuster, applying the brakes.

Driver alert — compounding of brakes

Always be sure that the spring parking brakes are released before making heavy service brake applications, like during a pre-trip inspection.

When spring parking brakes are applied, there’s up to 2,000 lbs of force applied to all of the brake components. If a heavy service brake application is made, the force of the air application is added to the spring force. This could add a further 3,000 lbs for a total of 5,000 lbs. This adding together of the two forces, known as **compounding**, can damage slack adjusters, s-cams, brake chamber mounting bolts, brake shoe rollers, shoes and brake drums.

Note that lighter brake applications of less than 30 to 40 p.s.i. (207 to 276 kPa), to prevent a vehicle from rolling while the spring parking brakes are being released or applied, aren’t harmful.

driving tip

Avoid compounding the brakes.

Always release the spring parking brakes before making a heavy service brake application.

Spring parking brake — manual release

Most spring parking brake chambers have a means of manually releasing (or “caging”) an applied spring parking brake. This feature should only be used by mechanics when making a repair.

If all air’s lost and the vehicle has to be towed, spring parking brakes can be released by caging them. Always block the wheels when caging spring parking brakes. Once a spring brake chamber is caged, there’ll be no parking brake force at that wheel.

Some chambers have a built-in release bolt while others have a release bolt, nut and washer carried in a bracket mounted on the chamber housing.

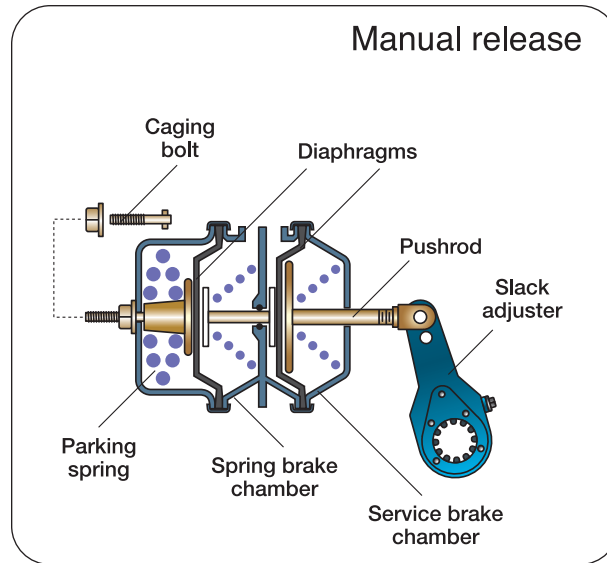

The spring has been caged using a caging bolt.

driving tip

Caging spring parking brakes should be done only in an emergency.

Once a spring brake chamber is caged, there'll be no parking brake force at that wheel.

This diagram shows how one type of release bolt is inserted into the rear of the spring parking brake housing. The release bolt is then given a quarter turn to lock it in place. Then the release nut is turned until the spring is compressed.

Instructions for manual release are usually imprinted on the housing of most spring parking brake chambers.

Before trying to manually release spring parking brakes, block the wheels to prevent the vehicle from rolling. To move a vehicle after manually releasing the spring parking brakes call a tow truck.

Spring parking brakes in dual air brake systems

This installation takes advantage of the primary and secondary reservoirs to supply the parking brake dash control with air from the tank that has the highest pressure.

fast fact

The effectiveness of spring parking brakes depends on how well the brakes have been kept in adjustment.

Spring parking brakes installed in a dual air brake system. The brakes are off.

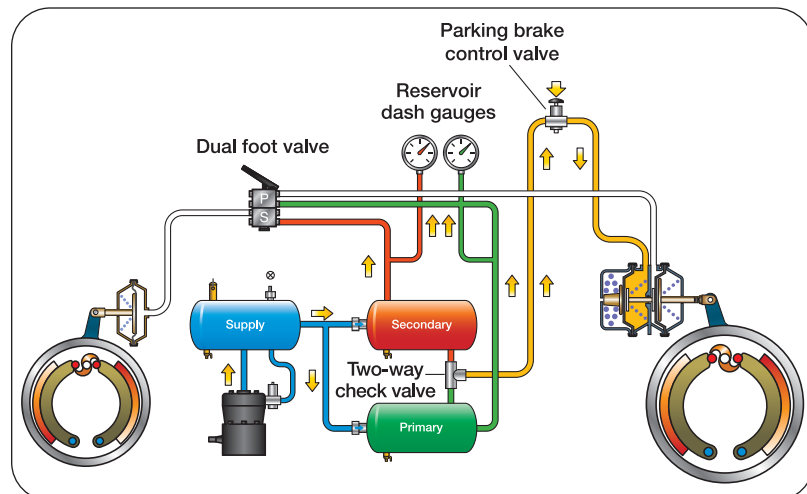

This is accomplished by the use of a **two-way check valve**. The air that is delivered from the two-way check valve is frequently called **blended air**.

Blended air

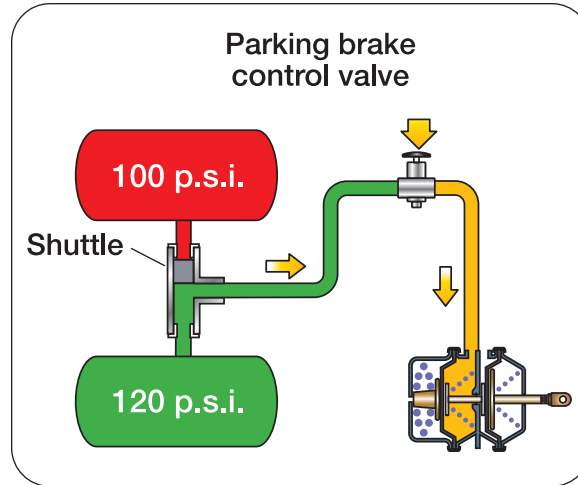

The two-way check valve draws air from the tank with the highest pressure.

The two-way check valve has two inlet ports and one delivery port. A free-floating shuttle within the valve will move away from the inlet that has the higher pressure, and the higher pressure will be supplied to the parking brake control.

This arrangement will also ensure that the spring parking brakes will not automatically apply if there's a total loss of air pressure in either reservoir.

Dual air brake system — partial system failure

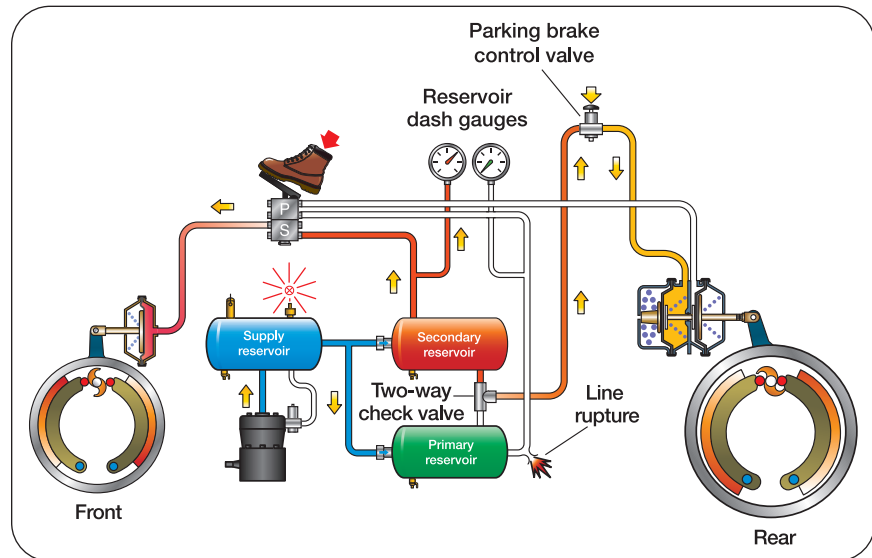

With the ruptured air line from the primary reservoir, the driver can still make a controlled stop.

This diagram shows the benefit of the blended air supply for the parking brake system. There has been a loss of air from the primary reservoir. The two-way check valve shuttle has moved so that secondary reservoir pressure supplies the parking brake control valve.

driving tip

One method to check that the two-way check valve is working is to drain the primary reservoir and check that air pressure in the secondary reservoir doesn't bleed back into the primary reservoir.

The result is that the spring parking brakes don't apply automatically. The low-air warning system has alerted the driver to the air loss, allowing the driver to make a controlled stop using the front axle brakes.

Some vehicles with dual air systems are equipped with an optional device called a **spring brake modulator**. This device senses a loss of pressure in the primary system, and when the driver applies the service brakes, causes air to be exhausted from the spring parking brakes in direct proportion to the brake application. By simply applying the foot valve normally, the driver controls the amount of spring force used to assist the front brakes to bring the vehicle to a controlled stop.

All vehicles must meet Canadian Motor Vehicle Safety Standards for emergency stopping, so regardless of how the dual system is arranged, or if a spring parking brake modulator is installed, the vehicle will have adequate braking force even with a partially failed air system.

With all systems, after stopping, the driver can securely park the vehicle by manually applying the parking brake control valve.

Safety actuator parking brakes

Safety actuator parking brakes are used on many buses and highway coaches. They look similar to spring parking brakes but their operation is very different.

Rather than using a powerful coil spring, this brake uses a one-way locking mechanism that can be engaged to allow the pushrod to stroke outward, but prevent it from returning. The actuators have two diaphragms: one to apply the service brake, and the other to apply the parking brake.

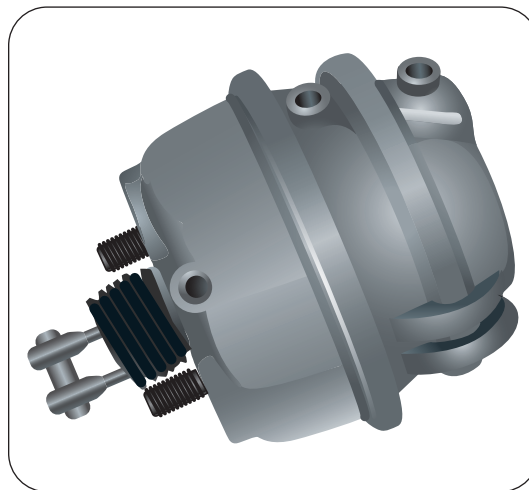

Safety actuator parking brake chambers are found on some buses.

A separate air reservoir is used for parking and the parking brake dash control is identical in appearance and operation to the one used for spring parking brakes.

Pulling the dash control outward simultaneously applies air pressure to the parking diaphragm and engages the locking mechanism. The pushrod moves out, applying the brakes. The pushrod is then held in the applied position by the locking mechanism. The vehicle's parked securely, even if air's lost from all reservoirs.

Normally, pushing the dash control inward causes air to exhaust from the parking diaphragm and at the same time releases the locking mechanism, allowing the pushrod to retract. But if more than 4 p.s.i. (27.6 kPa) pressure has been lost from the parking reservoir, the parking brakes will not release. A heavy service brake application must also be made, causing the pushrod to move slightly ahead, allowing the locking mechanism to disengage.

Because spring force is not used for parking, safety actuator parking brakes can't be compounded.

Note that safety actuator parking brakes will not apply automatically, even if service reservoir pressure is drained or pumped down to zero. Only loss of pressure in the parking reservoir will cause automatic application.

Tractor-trailer air brake systems

To understand the basics of tractor-trailer air brake systems, it's best to start with the trailer. Once you understand the trailer system, it becomes simpler to understand the components that are needed to tow a trailer.

A trailer system has many of the components found on a truck system: foundation brakes, air chambers, air reservoirs and control valves. The only major item not found on a trailer air system is an air compressor.

The trailer system must rely on the tractor for two important needs. First, the trailer must receive the compressed air from the tractor to fill the trailer reservoirs. Second, the trailer system must receive the commands from the tractor about when to apply and release the brakes.

To fulfill these needs, there are two air line connections between the tractor and the trailer air systems.

The air line that supplies the trailer reservoirs with air at full tractor reservoir pressure is called the **supply line**. It's sometimes called the **emergency line**.

The line that carries the control signal from the tractor is called the **control line**. It's also commonly called the **service line**.

Because tractors and trailers need to be disconnected and reconnected from time to time, the air lines are equipped with quick coupling devices called **glad hands**. Each coupler resembles a human hand about to make a handshake. Glad hands are often colour-coded — a blue line or blue colouring indicates the control line, and red's used to indicate the supply line.

fast fact

The supply line may also be called the emergency line.

The control line may also be called the service line.

Glad hands allow easy and quick connection between the tractor and trailer.

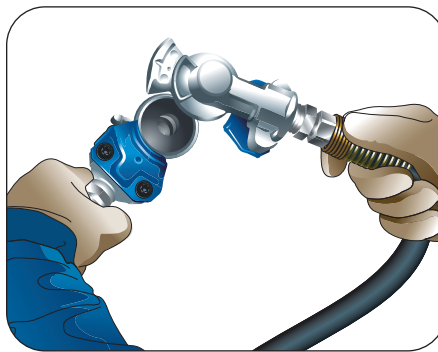

driving tip

When not in use, glad hands should be fastened to dead-end (dummy) couplers or to each other to prevent dirt and debris from entering the air lines.

Glad hands should also be secured to prevent the lines from chafing against other components or bouncing off the vehicle.

There are two basic types of trailer air systems — those that use spring parking brakes and those that don't. Although most current trailers use spring parking brakes, some older trailers and converter dollies in use aren't equipped with spring parking brakes.

All trailer systems must have an emergency stopping system that will fully apply the trailer brakes if the trailer separates from the tractor.

Trailers that aren't equipped with spring parking brakes use a device called a **relay emergency valve**. If this valve senses that the trailer has broken away from the tractor, it applies the trailer service brakes with full trailer reservoir pressure. This action is called **dynamiting** the trailer brakes.

Trailers equipped with spring parking brakes use the spring force to apply the brakes (dynamite the trailer brakes) if the trailer breaks away from the tractor.

Trailer with relay emergency valve — charging

This diagram shows a trailer equipped with a **relay emergency valve**. Air is passing from the tractor through the supply line to the relay emergency valve, filling the trailer reservoir.

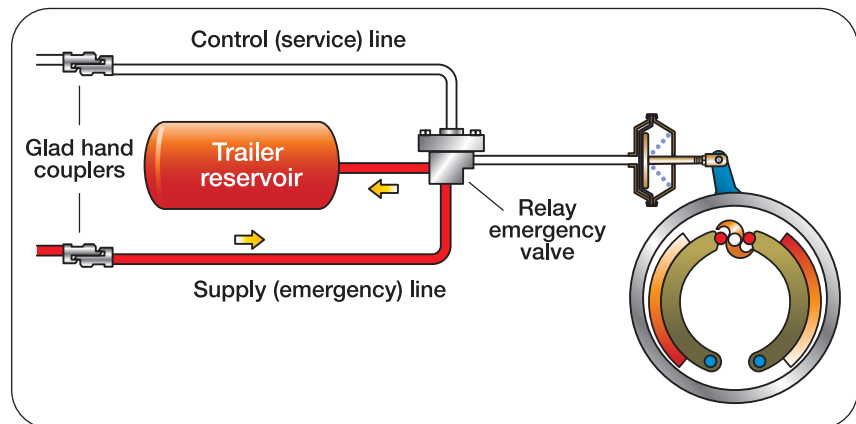

Compressed air from the tractor flows through the supply line to fill the trailer reservoir.

Trailer with relay emergency valve — applying

This diagram shows a normal service brake application. A control signal from the tractor has been sent through the control line to the relay emergency valve, which reacts to this signal in exactly the same way as the tractor relay valve previously described.

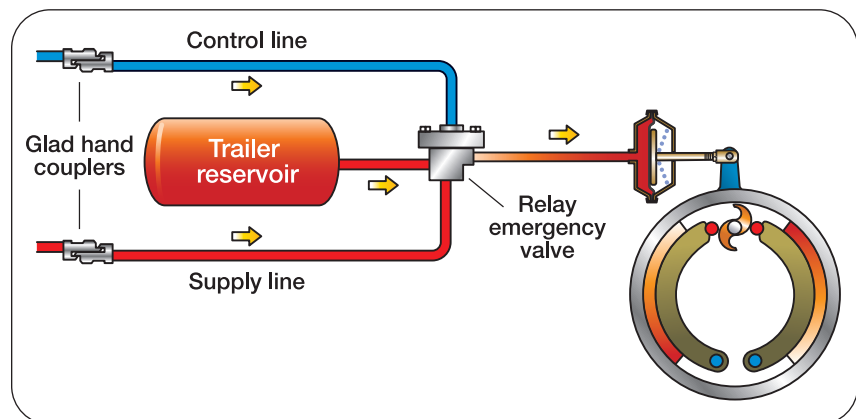

When the driver makes a brake application, air flows through the control line.

The relay emergency valve has drawn air from the trailer reservoir and delivered it to the trailer service chambers at approximately the same pressure as the control signal.

On highway trailers, one reservoir and one relay emergency valve are used for single or tandem axles. Some tandem logging trailers are equipped with a reservoir and a relay emergency valve for each axle.

Trailer with relay emergency valve — dynamited

This diagram shows a broken supply line. The relay emergency valve has sensed the loss of pressure in the supply line, and has delivered full trailer reservoir pressure to the service brake chambers, dynamiting the brakes. The trailer brakes will remain applied as long as pressure is retained in the trailer reservoir.

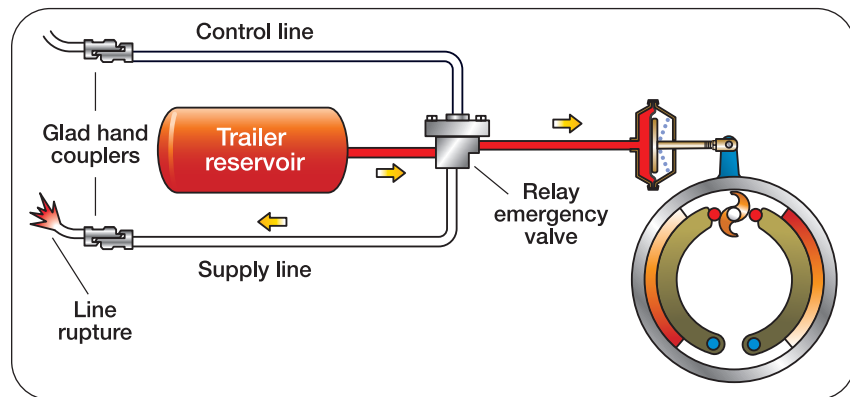

The trailer brakes will also be dynamited each time the glad hands are disconnected, or when the driver closes the trailer supply valve that is located on the tractor dashboard.

Motor vehicle safety standards require these systems to remain applied for a minimum of 15 minutes.

It's important to follow proper procedures when coupling a tractor to a parked trailer to prevent the trailer from moving and possibly causing damage. Coupling procedures are detailed in **chapter 5, skills for driving trucks and trailers**.

Trailer with spring parking brakes — charging

This diagram shows a typical trailer system that uses spring parking brakes for parking and for emergency (breakaway) stopping.

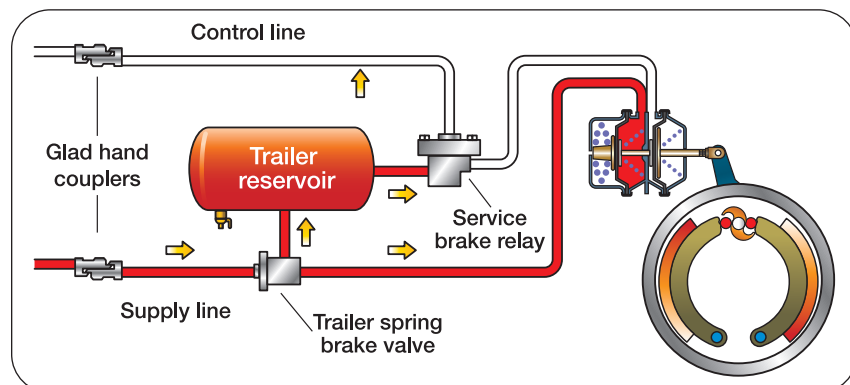

warning!

Small leaks in trailer systems without spring parking brakes can reduce or deplete the applied pressure, possibly allowing a parked trailer to roll away.

Always block the wheels of a parked trailer so it can't roll.

The broken supply line has caused the trailer brakes to dynamite.

This trailer is equipped with spring parking brakes.

driving tip

This is how you can tell if you have reversed the supply line and service line connections:

- the spring parking brakes won't release even when you use the parking brake control on the dashboard
- the trailer service brakes won't function.

Avoid these situations by taking care in coupling to a trailer.

driving tip

Always perform a tug test after coupling the tractor to a trailer.

Before conducting a tug test, use a flashlight to visually check that the fifth wheel locking jaws are closed and locked.

The trailer brakes have been applied by pressing on either the foot valve or applying the hand valve, or both.

The system shown uses one reservoir and two air valves, a **relay valve** for the service brakes, and a **trailer spring brake valve** that fills the reservoir and controls the spring parking brakes.

Other systems may be equipped with one, two or three air valves and multiple reservoirs. But using more or fewer air valves or additional reservoirs won't alter the basic operation of the system.

The tractor is delivering air through the supply line to the trailer spring brake valve. The spring parking brake valve directs air to fill the reservoir(s) and to release the spring parking brakes.

Here are the two types of systems:

- one fills the reservoir(s) before releasing the spring parking brakes
- the other releases the spring parking brakes first, then fills the reservoir(s).

Always perform a tug test after coupling the tractor to the trailer. Follow the coupling procedures as shown in **chapter 5, skills for driving trucks and trailers**.

Trailer with spring parking brakes — service brake application

In this diagram, a control signal from the tractor has been sent through the control line to the trailer's relay valve. The relay valve has drawn air from the trailer reservoir and delivered it to the trailer service brake chambers at approximately the same pressure as the control signal.

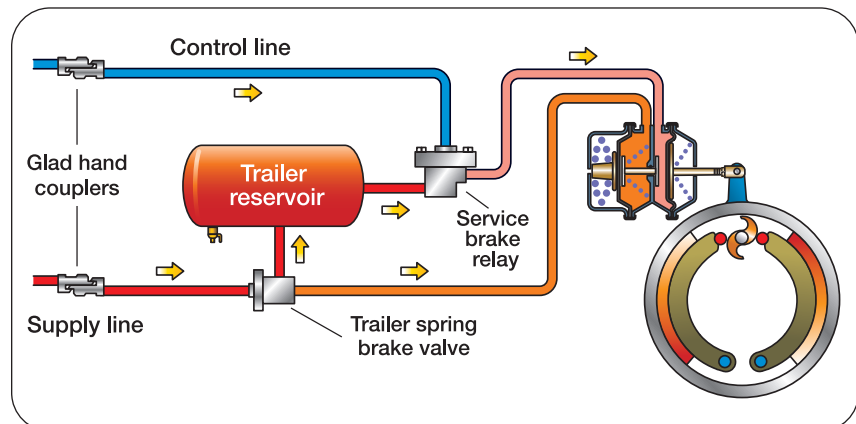

Trailer with spring parking brakes — dynamited

This diagram shows a broken supply line. The trailer spring brake valve has sensed the loss of pressure in the supply line and has exhausted the air pressure from the spring parking brake chambers, causing the spring parking brakes to apply. Note the burst of air from the exhaust port of the trailer spring brake valve.

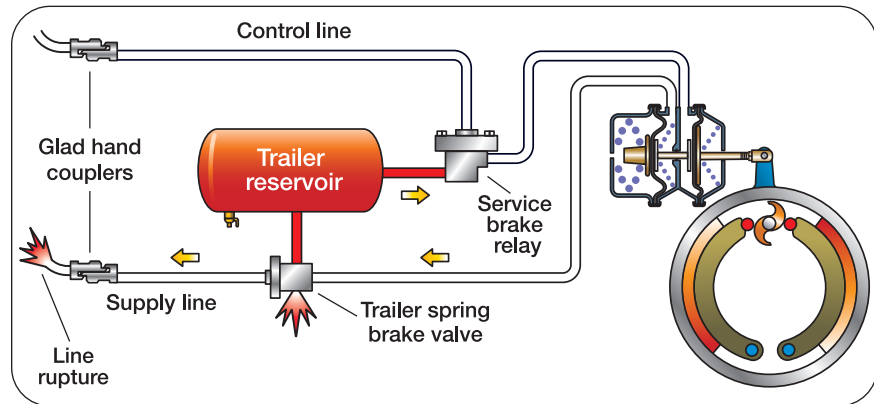

The supply line has broken, causing the trailer spring parking brakes to apply.

This action can also be called dynamiting of the trailer brakes. The trailer brakes will also be dynamited each time the glad hands are disconnected, or when the driver closes the trailer supply valve that's located on the tractor dashboard.

Tractor protection

If the mechanical connection between the tractor and trailer fails, causing the trailer to separate from the tractor, the two connecting air lines break. Air pressure from the tractor system rushes out through the broken supply line, and if the driver applies the brake, air pressure would rush out through the broken control line.

To prevent the tractor air from being depleted to an unsafe level, tractors are equipped with a **tractor protection system**.

A tractor protection system consists of a **trailer air supply valve** located in the tractor dash, and a **tractor protection valve**, usually located behind the tractor cab. All of the supply and control air delivered to the trailer passes through the tractor protection valve.

If the trailer breaks away, the tractor protection system will automatically shut off air loss from the tractor, preserving enough pressure for the driver to make a safe stop.

Some tractor protection systems will shut off immediately in a breakaway, but some will allow tractor pressure to drop to as low as 20 p.s.i (138 kPa) before shutting off.

Proper operation of the tractor protection system should be checked as part of the daily pre-trip inspection.

fast fact

A peace officer may place your vehicle out of service if the tractor protection system allows the tractor pressure to drop below 20 p.s.i. (138 kPa) without the trailer air supply valve automatically closing.

Trailer air supply valve

Once the supply line is connected to the trailer, there needs to be a way of directing air pressure to the trailer.



Trailer air supply valve.



This is the job of the dash mounted **trailer air supply valve**. It senses air pressure in the supply line that carries air to the trailer system. Most trailer air supply valves are an octagon-shaped red button.

Hand valve

Applying the foot valve directs approximately the same application pressure to both the tractor and trailer brakes. For example, if you make a 20 p.s.i. foot valve application, this application pressure will be applied to both the tractor and trailer brakes.

There are times when you want to apply only the trailer brakes without applying the tractor brakes, such as when coupling the tractor to a trailer.



The hand valve allows independent control of the trailer brakes. Some are mounted on the steering column, others are mounted in the dashboard.



warning!

DO NOT use the hand valve for parking.

Apply the tractor parking brakes, close the trailer supply valve and block the trailer wheels.

This is the purpose of the **hand valve**. When the trailer air brake system is fully connected to the tractor, the hand valve allows you to apply the trailer brakes independently of the tractor.

The hand valve should not be used in normal or emergency situation braking. Always use the foot valve for service braking.

Most hand valves are spring-loaded, just like the foot valve, so that when you release it, it will return to the released position. Don't use the hand valve for parking.

Two-way check valve

The **two-way check valve** allows you to apply the trailer brakes independently. This valve is identical in construction to the one used in spring parking brake installations, except that it allows the highest application pressure from the hand valve or the foot valve to be directed to the trailer brakes.

Bobtail tractors

Driving a tractor without a trailer attached is called **bobtailing**.

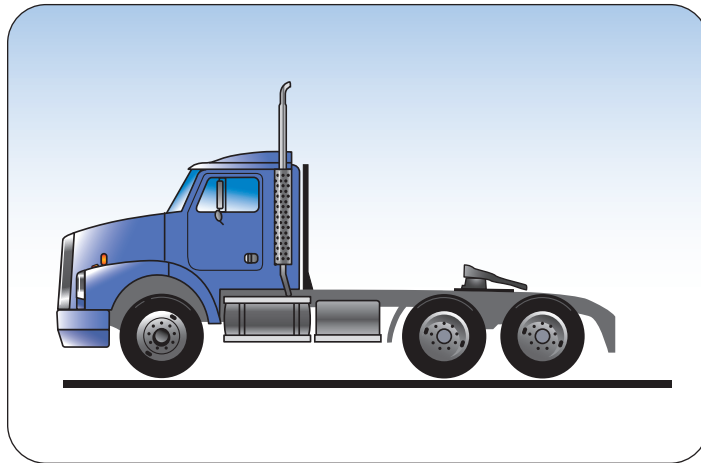

Driving a tractor without a trailer attached is called bobtailing.

Because a bobtail tractor has very little weight over the rear drive axles, it's very easy to lock up the rear brakes, even with a light brake application.

To help prevent this unwanted lockup and to increase control, some tractors are equipped with a **bobtail proportioning system**.

This system consists of two special valves: one controlling the steering axle brakes, and the other controlling the drive axle brakes.

When the tractor is being driven with a trailer attached, the tractor brakes operate normally.

When bobtailing, the braking pressure to the drive axle brakes is reduced by as much as 75 per cent, preventing the rear brakes from locking. The steering axle brakes receive full application pressure.

A tractor with a bobtail proportioning system will stop in a shorter distance and control will be increased, especially on wet or slippery road surfaces.

Because the steering axle brakes are doing most of the braking, a higher than normal pedal pressure is required.

Dual air tractor-trailer system — foot valve applied

A dual air tractor system for towing a trailer.

Note — Depending on the air brake system configuration used, the hand control valve may be supplied from blended air, or from primary or secondary reservoir pressure.

To avoid confusion, the air supply source to the hand valve is not shown in this diagram or in the diagrams on the next two pages.

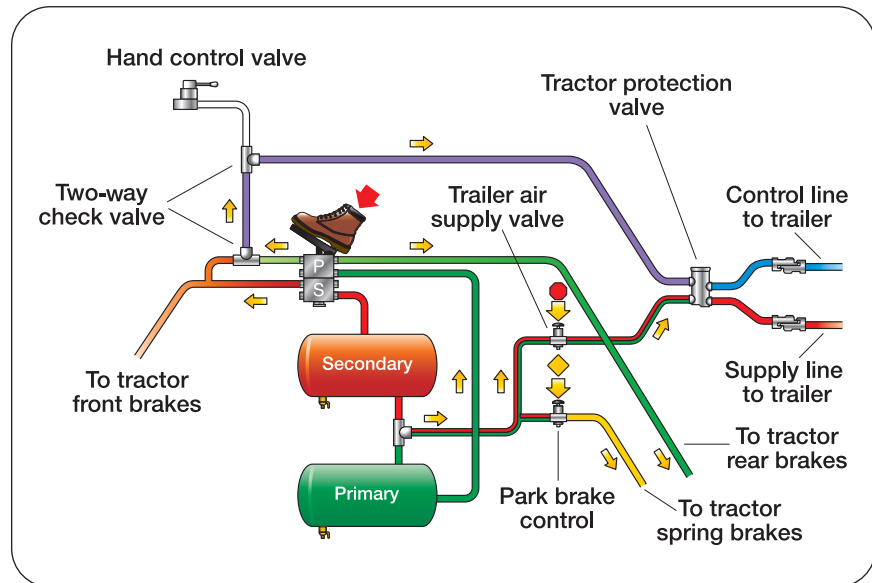

This diagram shows only the two service reservoirs, the dual foot valve, and the components that are added to a tractor with a dual air system so that it can safely tow a trailer with air brakes.

The components added are a trailer air supply valve, tractor protection valve, hand control valve, and a pair of two-way check valves.

Two-way check valves are installed so that whichever brake is applied — foot valve or hand valve — a control signal will be sent to the trailer.

The driver is making a foot valve application. The tractor front and rear brakes are being applied, and a control signal is being sent to the trailer through both of the two-way check valves.

Note that in most dual systems, the parking brake control valve (yellow button) is interlocked with the trailer supply valve (red button) so that applying the parking brake control valve causes all of the parking brakes on both the tractor and trailer to apply.

Some tractors are equipped with three dashboard control valves — the parking brake control valve (yellow button), the trailer supply valve (red button), plus a tractor parking brake valve with a round blue button that can control the **tractor parking brakes** independently of the trailer brakes.

Dual tractor-trailer system — primary air system failure

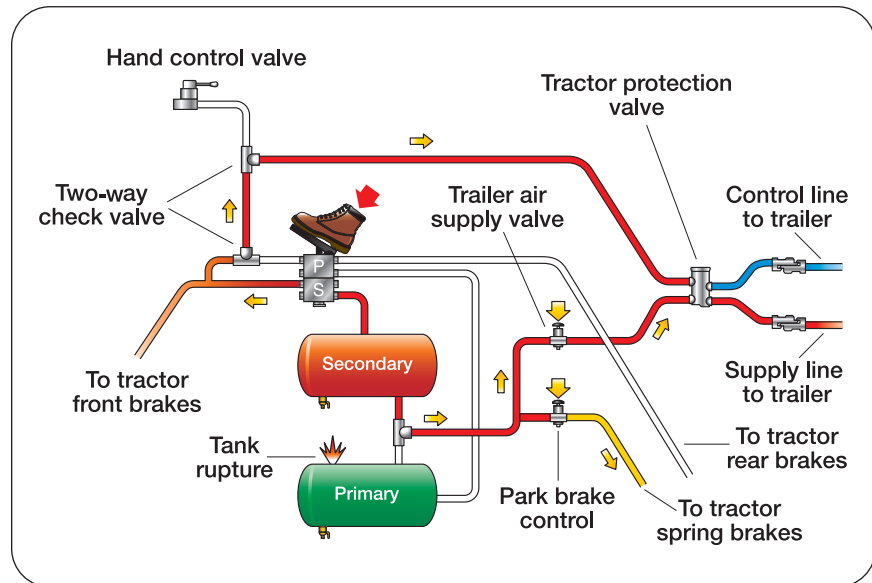

Despite the ruptured air line from the primary reservoir, the driver can still make a controlled stop.

fast fact

A peace officer may place a trailer out of service if the trailer brakes don't apply when the trailer air supply valve is closed.

This diagram shows a tractor with a dual air system where there has been a failure in the primary air system on the tractor. The low-air warning would have alerted the driver to the problem and a glance at the reservoir gauges would confirm that only one part of the dual air system had been lost.

The driver is making a foot valve application, causing the tractor front brakes to apply. Application air from the secondary foot valve is also passing through both of the two-way check valves, to the trailer control line, signalling the trailer brakes to apply.

If the secondary system had failed, a foot valve application would apply the rear tractor brakes, directing air through both of the two-way check valves to signal the trailer brakes to apply.

The same motor vehicle safety standards that require automatic shutoff of the air supply to the trailer — in the event that the pressure in the tractor air system is lowered to between 20 and 45 p.s.i. (138 and 310 kPa) — apply equally to tractors with dual air systems.

Because the trailer supply valve is now supplied with “blended air” from a two-way check valve, the automatic shutoff will not occur until the service reservoir with the **highest** pressure is lowered to between 20 and 45 p.s.i. (138 and 310 kPa).

The automatic shutoff requirement should be checked as part of a pre-trip inspection. If it doesn't function properly, the vehicle must be placed out of service until it is repaired.

Dual tractor-trailer system — trailer breakaway

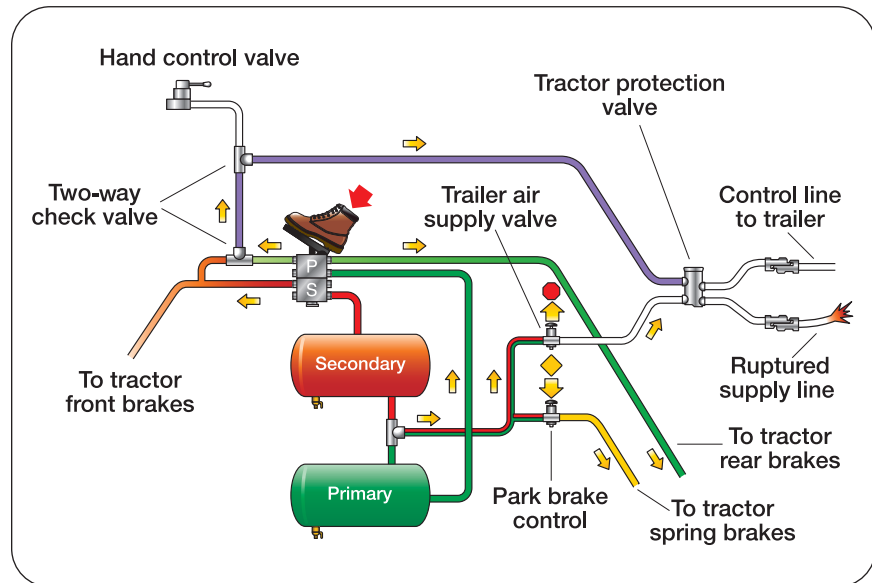

Despite the ruptured supply line, the driver can still make a controlled stop.

This diagram shows how the tractor protection valve and the trailer air supply valve act together to protect the tractor air supply from being depleted to an unsafe level if the trailer separates, causing the connecting lines to rupture. The sudden loss of air through the broken trailer supply line has caused the trailer air supply valve to shut off automatically.

The driver is making a foot valve application, causing the tractor service brakes to apply. The application pressure is also passing through both of the two-way check valves to the tractor protection valve.

Because there is no pressure in the supply line to the trailer, the tractor protection valve has closed the passage to the trailer control line. No application air can be wasted through that broken line.

If the control line separates, nothing will happen until the trailer brakes are applied. When that happens, the tractor protection system will activate to protect the tractor air supply.

When no trailer is connected, the trailer air supply valve will be in the closed position. This allows the tractor to be driven bobtail so that no air will be lost through the disconnected glad hand couplers.

Other types of foundation brakes

Here are the three other types of foundation brakes found on air-braked vehicles:

- wedge brakes
- air disc brakes
- air-over-hydraulic brakes.

Wedge brakes

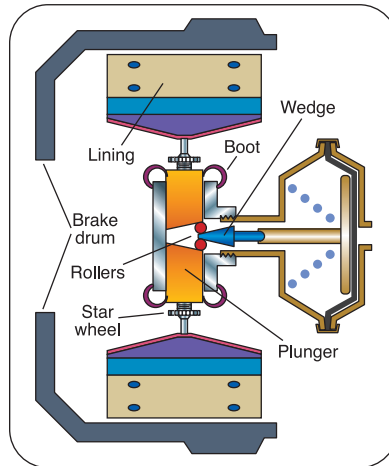

A typical wedge brake.

driving tip

Wedge brakes should only be adjusted or repaired by a qualified mechanic.

This type of brake uses one or two small air chambers with wedge-shaped pushrods. Wedge brakes are usually found only on steering axles.

When the brakes are applied, air pressure in the brake chamber pushes the wedge part of the pushrod between two rollers, forcing the brake linings out to contact the brake drum.

Most wedge brakes have internal automatic adjusters. Checking proper adjustment requires that inspection hole covers in the backing plate be removed so that brake linings movement can be checked while the brakes are applied and released. If either linings move more than $\frac{1}{16}$ of an inch, or a total of $\frac{1}{8}$ of an inch for both linings, the automatic adjusters have failed.

Unlike conventional s-cam braking systems, drivers can't easily check the wedge brake adjustment of a wedge brake.

Adjustment and repairs to wedge brakes should only be done by a qualified mechanic.

Air disc brakes

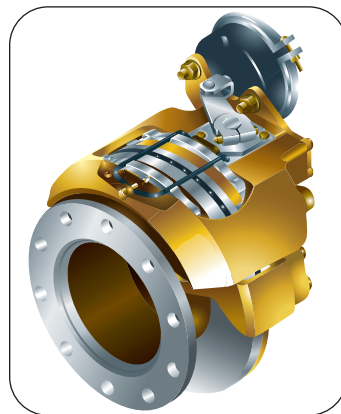

An air disc brake.

This type of brake uses a rotor, or disc, that's mounted to the wheel hub and rotates with the wheel. Two brake pads are located on either side of the rotor. When applied, the brake pads are pressed against the rotor. This action is similar to that of a large "C" clamp.

driving tip

Air disc brakes should only be adjusted or repaired by a qualified mechanic.

There are a number of different linkages used between the air chamber and the operating mechanism. This illustration only shows one type, but the principle of the others is similar.

Most air disc brakes feature an internal automatic brake adjustment mechanism to adjust for brake pad wear. Chamber stroke limits are the same as for automatic slack adjusters.

Unlike conventional s-cam braking systems, drivers can't easily check the adjustment of an air disc brake.

Make sure adjustment and repairs to air disc brakes are only done by a qualified mechanic.

Air-over-hydraulic brakes

Air-over-hydraulic brakes are often found on middleweight trucks and buses. This type of braking system combines the features of an air brake system and a hydraulic braking system.

Hydraulic foundation brakes offer several advantages on commercial vehicles of this size, including light weight, compact size and proven automatic adjusting mechanisms.

Most middleweight commercial vehicles of this size were once powered by gasoline engines, which supplied a source of engine vacuum so that vacuum boosters for the hydraulic brakes could be used. The now-common diesel engine doesn't supply a usable vacuum, so a partial air brake system has been adopted.

An air-over-hydraulic braking system.

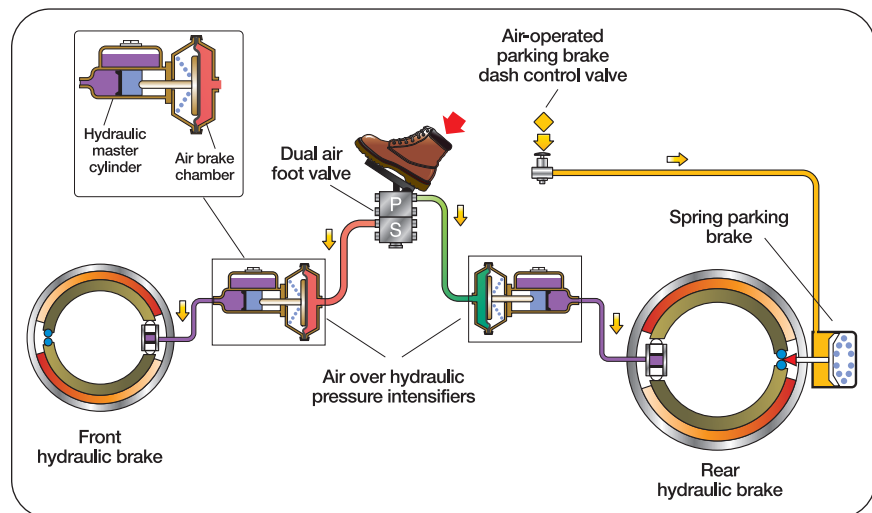

An air-over-hydraulic braking system (above) consists of a compressor, governor, air storage tanks, foot valve and two air-over-hydraulic **pressure intensifiers**. The system may also include spring parking brakes. Like a full air brake system, typical air-over-hydraulic braking systems use a standard air pressure of around 125 p.s.i. (862 kPa).

fast fact

An air brake-endorsed driver's licence is required to operate most vehicles equipped with air-over-hydraulic brakes.

The only exception is if the brake system doesn't use an air treadle. In this case, an air brake-endorsed driver's licence isn't required.

driving tip

Check gauges frequently to make sure there's adequate air pressure to apply the brakes.

A standard dual air foot valve is used. Pressing on the foot valve directs air pressure to the air-actuated side of the hydraulic pressure intensifiers, causing the hydraulic-actuated side of the intensifiers to direct hydraulic pressure to the foundation brakes. In other words, air pressure actuates the braking action, but hydraulic pressure delivers the braking force to the foundation brakes to stop the vehicle.

To provide a parking brake, many air-over-hydraulic braking systems have a parking brake chamber attached to the foundation brake.

The parking brake is controlled by the same dashboard-mounted parking brake control valve used on vehicles with full air brake systems. Applying the parking brake control valve on the dashboard applies the spring in the parking brake chamber, which forces a wedge between the brake shoes to apply the brakes. Releasing the parking brake control valve directs air pressure to the parking brake chamber to contract the wedge and spring.

Like a full air brake system, if there were a serious air leak in an air-over-hydraulic system, eventually the brakes would stop functioning properly. For this reason, drivers need to know and understand how the system works, and check air pressure gauges frequently.

Other air brake system components

Here are other components commonly found in air brake systems.

Air dryers

Air dryers are optional devices that are installed in the compressor discharge line between the compressor and the first reservoir. They're designed to remove any water vapour, oil mist and carbon particles from the air before it's delivered to the first reservoir.

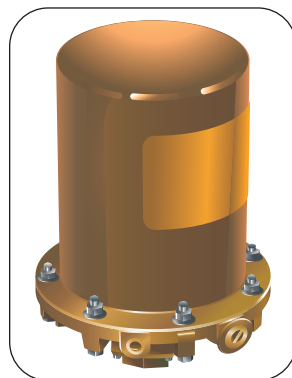

The warm, moist air from the compressor enters the dryer where a certain amount of the water vapour condenses on cool metallic surfaces. The air then passes through a filter that removes any oil and through another filter that removes the remaining water vapour. From there the clean air passes through an internal one-way check valve, and onto the first reservoir.

When the reservoir has come up to full pressure, a purge port in the bottom of the air dryer will open. The collected contaminants are ejected along with a sudden burst of air.

At the same time, a certain amount of clean air is allowed to flow back through the filters. This reverse flush effect cleans both filters in readiness for the next compression cycle. The purge port remains open until the compressor resumes pumping.

Some air dryers are equipped with an electric heating element to prevent freezing in cold weather.

In systems with an air dryer, the safety valve is often installed at the air dryer rather than at the supply reservoir.

Most new air brake systems include an air dryer.

fast fact

Even if the air brake system includes an air dryer, air reservoirs should still be drained regularly to check for contaminants.

driving tip

If you notice more than a few drops of water when you drain the supply reservoir, the air dryer or compressor may need servicing.

Check the air dryer operation by periodically looking for water in the reservoirs. More than a few drops may indicate that the air dryer or compressor needs servicing.

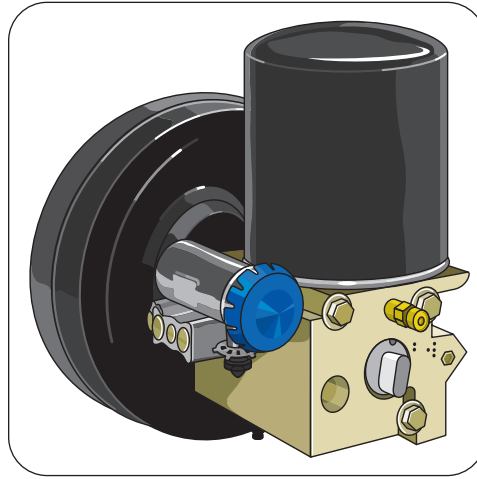

There's also an integrated air dryer system that's common with most modern truck manufacturers. This system combines the spin-on filter, dryer and governor into one unit. It also includes a purge reservoir that provides the air volume to purge all moisture and contaminants from the dryer cartridge, each time the air compressor unloads. The former 'wet' or 'supply' reservoir isn't needed in this system. There are pressure protection valves to protect the primary and secondary service reservoirs and any air accessories from a pressure loss. These valves are factory set and shouldn't be adjusted. A unique feature is that air pressure builds in one service reservoir first. When pressure reaches approximately 100 psi the other reservoir will begin to fill. Pressure in both service reservoirs and the air accessories circuit will then build to full pressure. Maximum pressure may be up to 135 psi.

Alcohol evaporators and alcohol injectors

fast fact

Even if the air brake system includes an alcohol evaporator or alcohol injector, air reservoirs must still be drained regularly.

Alcohol evaporators and **alcohol injectors** are optional devices that introduce a small amount of alcohol vapour into the air system. The alcohol vapour combines with any moisture that may be present. In effect, the alcohol acts as an anti-freeze, lowering the freezing point of any moisture that's collected in the air system.

Alcohol evaporators are connected to the inlet side of the compressor so that alcohol vapour is drawn in and compressed along with the intake air, which is then carried throughout the system.

Alcohol injectors are installed in the compressor discharge line between the compressor and the supply reservoir. The discharge air passes through a venturi (a tube with a narrow section, which causes air flowing through the tube to create a vacuum), picking up alcohol vapour and carrying it throughout the system.



An alcohol evaporator bottle.

driving tip

Only use products specifically designed for use in air brake systems in alcohol evaporators or alcohol injectors.

The alcohol reservoir should be kept topped up with methyl hydrate during the winter months. It's a good practice to begin before the first freeze of the season to ensure trouble-free operation.

These systems are designed to use pure methyl hydrate to provide the alcohol. Be sure to use only methyl hydrate specifically formulated for use in alcohol evaporators or alcohol injectors.

Automatic drain valves

Automatic drain valves (sometimes called "spitter valves") are optional devices installed on some or all of the reservoirs on some air brake systems. They intermittently expel any contamination that's collected.

Most are self-contained and open briefly each time reservoir pressure lowers two or three p.s.i. (13.8 or 20.7 kPa), but some are connected to the compressor governor and open briefly each time that the compressor cycles.

Some automatic drain valves are equipped with an electric heating element to prevent freezing in cold weather.

The manual drains should be opened periodically to check for the presence of water in reservoirs.

If you find contaminants or more than a few drops of water, the compressor or air dryer may need servicing, or the automatic drain valve may not be functioning correctly.

Front wheel limiting systems

Some vehicles may have an optional system to reduce the possibility of steering axle brake lockup and loss of steering control on slippery surfaces. There are two types of front wheel limiting systems:

- automatic front wheel limiting systems
- manual front wheel limiting systems.

Automatic front wheel limiting systems

This consists of a limiting valve, sometimes called a ratio valve, mounted near the steering axle. There's no dashboard control.

driving tip

On vehicles equipped with a manual front wheel limiting valve, keep the control in the normal (Dry Road) position to have normal braking efficiency.

Under the *Motor Vehicle Act*, the Slippery Road position valve may only be used when weather conditions make its use essential for safety.

A manual front wheel limiting control.

At very low application pressures, no air pressure is delivered to the steering axle brakes. As application pressure exceeds the holdback point (five to 15 p.s.i. — 34.5 to 103 kPa), limited application pressure is delivered to the steering axle brakes. At brake application pressures below 40 p.s.i. (276 kPa), the steering axle brake pressure is approximately 50 per cent of drive axle pressure.

At application pressures above 40 p.s.i., the percentage gradually rises, until it reaches an application pressure that may be used during an emergency stop (60 to 70 p.s.i. — 414 to 483 kPa) and steering axle and drive axle brakes receive equal pressure. A built-in quick release function helps to speed up the release of the steering axle brakes.

Manual front wheel limiting systems

These are no longer installed on new vehicles. This type of system consists of a limiting quick-release valve mounted near the steering axle brakes, and a dash mounted control valve. The control valve may be a “flip” type switch, as shown, or a push-pull type.



With the control valve in the “dry” position, the steering axle brakes are applied with the same pressure as the drive axle brakes.

The “slippery” position limits the application pressure to the steering axle brakes to 50 per cent of drive axle brake application.

Commercial vehicle safety standards allow reduced braking on steering axle brakes only

when weather and road surface conditions make such operation essential to safety. Tests have shown that front wheel skids aren’t as dangerous as the drive axles locking up.

The limiting quick release valve also acts as a normal quick-release valve, helping to speed up the release of the steering axle brakes.

Spring parking brake emergency release system

This system provides a special emergency release tank that can be used to release spring parking brakes if a disabled vehicle needs to be moved to a safe parking area and its main reservoir pressure is lost.

A second dashboard control valve is added so that air from the emergency release tank can be directed to the spring parking brakes to release them. This control valve is usually a “dead man” type that must be held in place while the vehicle is being moved. Once the vehicle has been moved, the spring parking brakes are re-applied by releasing hand pressure from the control.

Instructions for operating the emergency release system are usually found on the control valve or on a decal on the dashboard.

The popularity of this system was reduced with the introduction of the dual air system, but it’s still sometimes used on transit buses, school buses and fire trucks.

fast fact

Spring parking brake emergency release systems are sometimes called “California spring parking brake systems.”

Pressure-protection valves

Pressure-protection valves are often installed between the service brake reservoirs and any non-essential air-operated accessories such as air seats, air horns, air windshield wipers, air suspensions, fifth wheel sliders and air shifts. Some air brake systems integrate the air dryer with the supply reservoir — these also use pressure-protection valves.

They're designed to cut off the air supply to these systems if a failed accessory causes the service reservoir pressure to drop below a preset pressure, ensuring that sufficient pressure is maintained in the service system so that a safe stop can be made.

Shutoff pressures vary between 60 and 90 p.s.i. (414 and 620 kPa), depending on the manufacturer's specifications.

Application pressure gauges

Some vehicles have air pressure gauges to indicate application pressure as well as pressure in the reservoirs.



Some trucks and tractors are equipped with one or more optional gauges that indicate the actual pressure being delivered to the service brakes.

There may be a single gauge or separate gauges for tractor and trailer brake application.

Tractors may have a single gauge that indicates application pressure if either the foot valve or trailer hand control valve is applied.

Anti-lock braking systems

Anti-lock braking systems (ABS) are typically made up of three main sections: speed sensing, decision-making, and brake releasing or modulation.

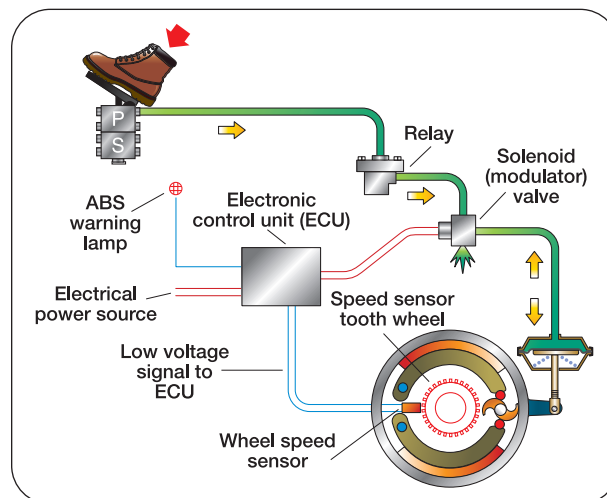

In this diagram, vehicle speed is sensed by magnetic pickups mounted in close proximity to toothed wheels that are attached to some or all of the wheel hubs. As the wheels rotate, a pulsating electrical current is generated.

This pulsating current is monitored by a simple computer called an **electronic control unit** (ECU). The ECU is powered by the vehicle electrical system. During normal brake application, if the ECU detects a sudden change in the pulsating current, the ABS system will activate.

If the brakes are applied too hard for road conditions, and a wheel lockup occurs, the rate of the pulsating current will rapidly decrease. The ECU, sensing the sudden drop in wheel speed, will signal electrically controlled solenoid air valves to release air pressure from the brake chambers at the affected wheels. The solenoid valves are frequently called **modulators**.

As the brakes begin to release, the wheels will regain traction, the pulsating current will be restored, and the ECU will allow the brakes to re-apply. If the lockup re-occurs, the apply-and-release cycle will repeat as often as necessary. Most systems are capable of cycling the brakes up to five times per second.

To achieve the shortest possible stopping distance on extremely slippery surfaces, you simply have to apply and maintain firm continuous pressure on the brake pedal. You need to apply the brake pedal in order to allow the ABS system work to stop the vehicle from skidding. The ABS system will rapidly apply and release the brakes as often as necessary. There may be some noise and vibration. ABS prevents the axle brakes from locking up allowing the driver to retain complete steering control.



The ABS lights for the tractor and trailer brakes should be on when you first start the tractor.

driving tip

When coupling to a trailer, always check to see if it's equipped with ABS.

Stopping in an emergency with a combination unit — where the tractor and all trailers are ABS-equipped — is quite different than stopping a combination where all the units do not have ABS.

Trucks and tractors are equipped with a dash mounted failure warning lamp that monitors the ABS system. When the ignition switch is first turned on, the ABS system performs a self-checking sequence. Depending on the system, the dash lamp may light, flash briefly, then stay lit until vehicle speed reaches 7–11 km/h, or light briefly then turn off.

If the lamp doesn't go out, or comes on during vehicle operation, it's signalling that there's been a failure in the ABS system. Normal braking is still operational, only the anti-lock feature is disabled. The vehicle may be driven to a service depot for repairs.

Trailer ABS air brake systems

Trailer ABS systems use similar components as those on trucks and tractors. The ECU may be powered from the stop lamp circuit, or may have a dedicated power source through the electrical connector.

Trailers with ABS air brakes will also have an indicator visible in the tractor's mirror to indicate if the system's not functioning properly. This warning light may be mounted on the front left side of the trailer or on the rear left side of the trailer.

On some air brake systems, there may be a trailer ABS warning indicator on the dashboard of the tractor.

This ABS warning light is positioned on the side of the trailer at the rear. The driver should be able to see it in the tractor side mirror.

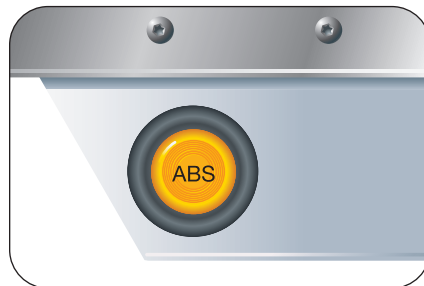

Review questions

1. Why are air brakes, rather than hydraulic brakes, used on heavy commercial vehicles?
2. What are the five components of a simple air brake system?
3. What prevents total loss of air pressure in the service brake system in the event of an air line rupture between the compressor and the supply reservoir?
4. How can you tell how much air pressure is in the main reservoirs?
5. What must you do if the low pressure warning indicator activates?
6. What's one advantage of a dual air brake system?
7. In a dual air brake system, if an air line in the secondary braking system ruptures, how would you know? What would happen if you then made a brake application?
8. How does a spring parking brake work?
9. What are the two ways that the spring in a spring parking brake chamber can be held in the released position?
10. Why should you avoid compounding the brakes?
11. Why are spring parking brakes a reliable type of parking brake?
12. What's the purpose of the tractor protection system on a tractor?
13. If a driver makes a 20-pound (138 kPa) brake application with the hand valve, what's the application pressure at the tractor brakes?
14. What would happen if the control line to the trailer becomes disconnected while you're driving the tractor-trailer combination?
15. How does a wedge brake work?
16. How does an air-over-hydraulic braking system work?
17. Where would an air dryer be installed in an air brake system?
18. If you make a full brake application during an emergency stop with an automatic front wheel limiting system, how much air pressure is directed to the front brakes?

fast fact

Your company may have a maintenance crew to keep vehicles safely running.

But one person is ultimately responsible to ensure that the brakes are operating properly before the vehicle is moved. That person is the driver.

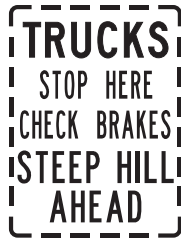
**fast fact**

You may be fined as much as \$2,000 if you're operating a vehicle with brakes that are defective. This includes excessive brake chamber pushrod stroke.

A typical s-cam brake. The brake is shown in the released position.

What you'll learn

After reading this chapter you'll be able to:

- explain why air brake adjustment needs to be regularly checked
- explain how to measure air brake chamber pushrod travel and how to adjust air brakes.

Brake adjustment — it's critical

The most important part of any braking system is the foundation brakes. If these are not in correct working order and properly adjusted, the best designed air brake system won't be able to safely stop the vehicle.

Brake failures and runaways that result in crashes are almost never caused by an air system failure. The absence of routine brake maintenance or the driver failing to check brakes on a daily basis is a much more common factor.

Daily pre- and post-trip inspections — including checking and adjusting brakes — are mandatory. The driver may be held responsible if the brakes are incorrectly adjusted or not working properly.

Brake adjustment — it's the law

Federal and provincial laws require that you check manual and automatic slack adjusters daily, during the pre-trip inspection. It's up to you, the professional driver, to ensure your vehicle has safe, correctly adjusted brakes.

You're also required by law to check your brakes before driving down steep grades that are posted with regulatory signs.

You can't always crawl underneath your vehicle to measure air brake chamber pushrod travel, but there are devices available to help you visually check for brake adjustment.

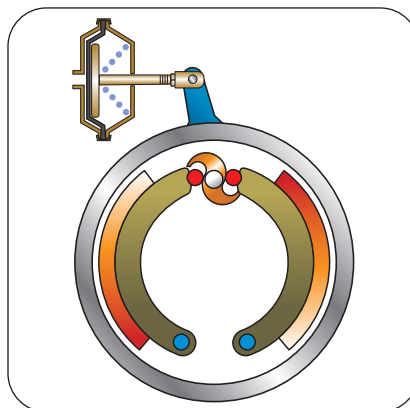
S-cam brake — released

definition

Slack adjustment means adjusting the brakes to keep air chamber pushrod travel within tolerance to ensure that the brakes are effective.

Pushrod travel means the distance the pushrod extends from the air brake chamber when the brakes are applied.

fast fact

When correctly adjusted, the running clearance between the brake lining and drum is only a few thousandths of an inch — hardly thicker than three sheets of paper.

A typical s-cam brake. The brake is shown in the applied position.

The most common type of air brake chamber used on trucks and trailers is the Type 30. These chambers have a maximum available stroke of 2½ inches (65 mm). A long stroke Type 30 is designated Type 30LS, and has a maximum available stroke of three inches.

S-cam brake — applied

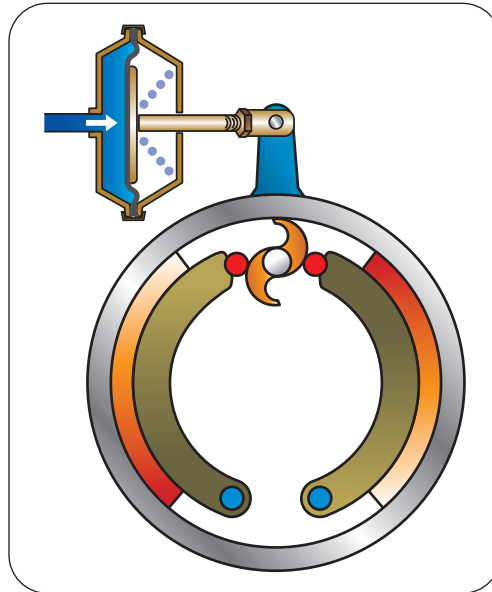

In this diagram, the brakes have been applied and the brake linings have contacted the brake drum. The brake chamber has stroked less than half of its maximum stroke, indicating that the brake is in correct adjustment.

S-cam brake — incorrectly adjusted and cold brake drum

In this diagram, the brakes are applied and the linings have contacted the brake drum.

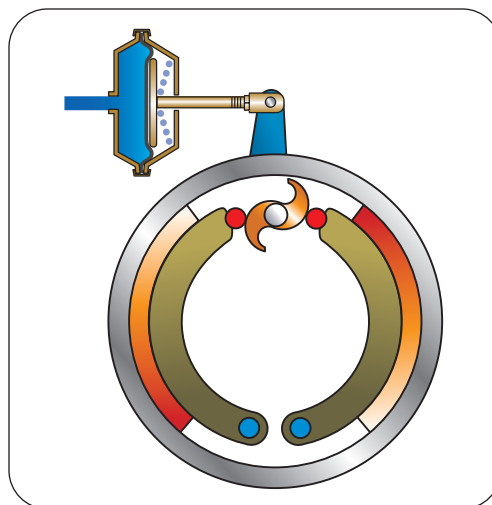

driving tip

Check air brake chamber pushrod travel at least daily.

Each brake on an axle should be adjusted to have a similar amount of pushrod travel — that is, the pushrod travel of the left brake should be similar to the pushrod travel of the right brake on the axle.

This brake chamber pushrod has excessive travel, but may work as long as the brake drum is cool. But it won't stay cool for long!

fast fact

Once you learn how, manual slack adjusters are easy to adjust.

Air-brake-equipped vehicles rarely “lose” their brakes. If the brakes don’t work properly, it’s likely because the brake system hasn’t been well maintained and the driver has failed to regularly check brake pushrod travel.

Now that the brake drum is hot, the brake linings will no longer contact the drum. The brake chamber has bottomed out.

warning!

Even incorrectly adjusted brakes may seem to work when brakes are lightly applied.

This could result in a dangerous brake system under moderate to heavy braking, or on a downgrade.

driving tip

Always block the wheels before checking any brakes.

Turn the engine off so that you can also listen for any air leaks.

Note that the brake chamber has stroked more than half of its maximum, which means that this air brake chamber pushrod has excessive travel and the brakes need adjustment.

When the brake drum is cool and with normal brake application pressure, the brake will seem to be effective, so it’s easy to be lulled into a false sense of security.

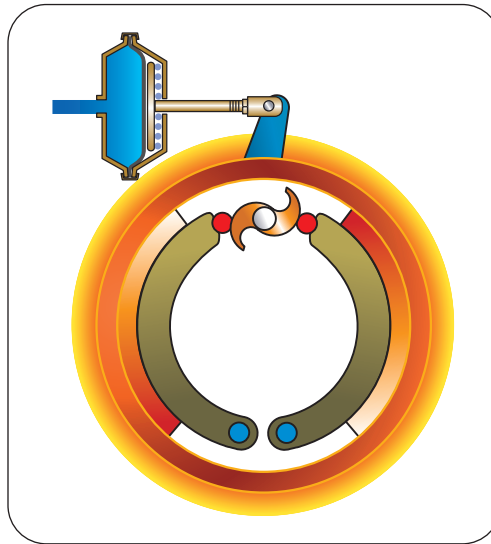
S-cam brake — incorrectly adjusted and hot brake drum

This diagram shows the same brake after a few brake applications.

Cast iron brake drums expand when heated, causing the air chamber to stroke further as the temperature rises.

If an unforeseen event required the driver to make a sudden stop, the brake chamber could **bottom out**, and braking power would be greatly reduced.

On long downgrades, the expansion of hot brake drums can cause a total loss of braking and result in a runaway.

Checking and adjusting s-cam brakes — manual slack adjuster

Drivers seldom have the luxury of the use of a pit and hydraulic jacks so that brake adjustment can be done with wheels off the ground.

But, brakes can still be adjusted very accurately with the wheels on the ground using one of the following methods.

Be sure that the vehicle is safely parked with the wheels blocked. The air system should be at full pressure and the spring parking brakes released.

Turn the engine off so that you can listen for air leaks.

There are two methods of checking for correct adjustment, but the measurements that indicate the need for adjustment are different.

Applied stroke method (service brake application)

The **applied stroke** method is the method used by roadside inspectors, and is also a method recommended by commercial fleet maintenance supervisors.

Unless you have a device to apply and hold the service brakes on, this method requires two people — one to apply the brakes and one to measure travel.

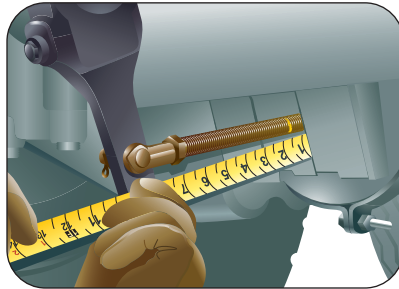

Checking the pushrod stroke by applying the brakes.

driving tip

While checking air brakes look for other brake component wear and excessive play including:

- s-cam bushing wear
- s-cam spline wear
- slack adjuster play (worn gear)
- clevis pin wear.

1. With the brakes released, reservoir pressure at least 100 p.s.i. (690 kPa), and the engine off, either:
 - a) make a mark on the pushrod where it exits the brake chamber or
 - b) measure the pushrod length from the clevis pin to the face of the brake chamber.
2. Apply and hold a full brake application of 90 to 100 p.s.i. (620 – 690 kPa).
3. With the brakes applied, either:
 - a) measure the distance between the mark on the pushrod and face of the brake chamber or
 - b) re-measure the pushrod length from the clevis pin to the face of the brake chamber.

The distance between the mark on the pushrod and the face of the brake chamber, or the difference between the two pushrod length measurements from the clevis pin to the face of the brake chamber, is called the applied stroke (1 inch to 1½ inches — 25 to 38 mm is a good range). If this distance is more than 1¾ of an inch (45 mm), the brakes need adjustment.

Pry method of free stroke measurement



Using a brake tool to measure brake chamber pushrod free stroke.

To begin, make sure system air pressure is over 100 p.s.i. (690 kPa) and all parking brakes are released.

1. Push against the pushrod to ensure that it's fully retracted into the brake chamber. Then make a mark on the pushrod where it exits the brake chamber.

driving tip

Make sure you have the proper equipment to check the brakes. You'll need:

- a flashlight to inspect components
- chalk or other marker, and a ruler or other marking device, to check pushrod free stroke
- a tool to pry on the air brake chamber pushrod to check for free stroke
- a wrench to adjust manual slack adjusters.

You should also wear sturdy clothing, a hard hat and eye protection.

If the red marking on the pushrod (at the chamber face) is visible, it indicates that the brake is dangerously out of adjustment and it needs **immediate** attention.

driving tip

While checking air brakes look for other brake component wear and excessive play including:

- s-cam bushing wear
- s-cam spline wear
- slack adjuster play (worn gear)
- clevis pin wear.

2. Pull the pushrod out from the brake chamber, using a tool like a pry bar for leverage.
3. Measure the distance between the chalk mark and the face of the brake chamber.

The distance between the mark on the pushrod and the face of the brake chamber is called the free stroke ($\frac{1}{2}$ to $\frac{3}{4}$ of an inch — 12 to 20 mm is a good range). If this distance is more than $\frac{3}{4}$ of an inch (20 mm), the brakes need adjustment.

Brake adjustment indicators

New air brake chamber pushrods have a marking (usually red) to indicate when brake adjustment must be done immediately. If the pushrod travel becomes excessive, the marking will show.

Don't wait until the red marking is exposed before adjusting the brakes.

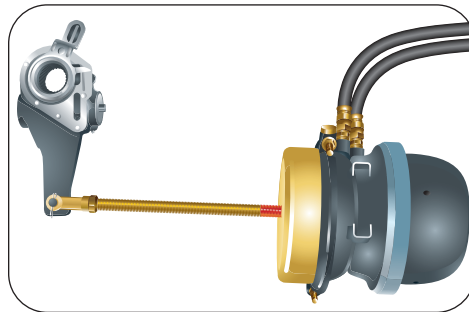

Brake adjustment — manual slack adjuster

With a typical Type 30 clamp type air chamber, you **must** adjust the brakes if pushrod travel is:

- more than $\frac{3}{4}$ of an inch (20 mm) using the pry method of free stroke measurement, or
- more than $1\frac{3}{4}$ of an inch (45 mm) using the brake application — applied stroke measurement method.

Note that these are maximum measurements. You should adjust the brakes if your measurements approach these limits.

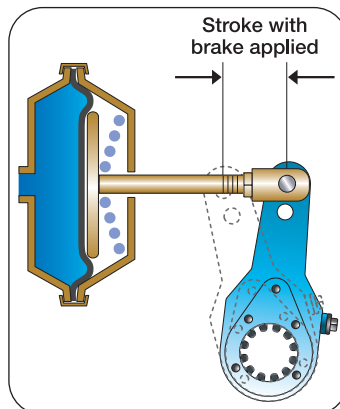

Adjustment

Most manual slack adjusters have a spring-loaded locking sleeve that must be pressed in and held so the adjusting bolt can be turned.

Depending upon the orientation of the slack adjuster, you may need to turn the adjusting bolt clockwise or counter-clockwise. There are two indicators to watch for to ensure that you're tightening and not loosening the slack adjustment.

With a wrench of the proper size, usually a $\frac{9}{16}$ inch, depress the locking sleeve and turn the adjusting bolt while watching the end of the camshaft. The camshaft will rotate slightly as the bolt is being turned. If you're turning in the right direction, the cam will rotate in the same direction that it would if the brakes were being applied, as shown by the arrow on the cam end in the diagram below.

If the pushrod goes into the chamber, this indicates that the previous slack adjustment was done incorrectly.

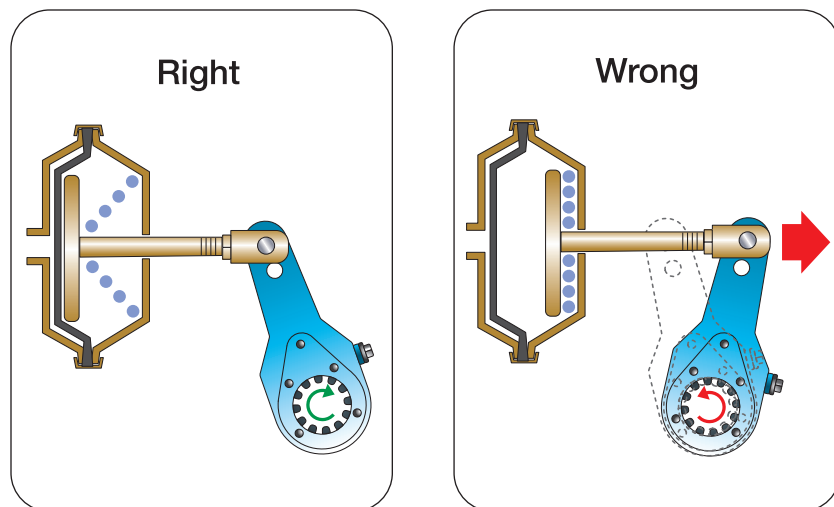

If the slack adjuster is pulling the pushrod out of the chamber when you turn the adjusting bolt, **stop**. The adjusting bolt is being turned in the **wrong** direction.

The pushrod and the slack adjuster arm should **never** move in or out while turning the adjusting bolt.

If the pushrod goes into the chamber, this indicates that the previous slack adjustment was done incorrectly.

Once you know the proper direction, continue turning until solid resistance is met. This indicates that the brake linings have contacted the brake drum.

If the brake has no dust shields, or if you can see the brake shoes and linings through an inspection slot, you can visually verify that the linings have contacted the drum.

Backing off the adjusting bolt about $\frac{1}{3}$ of a turn should establish correct running clearance between the lining and drum. Be sure the locking sleeve re-engages the bolt so that the adjustment will not back off.

driving tip

Have an adjusting wrench at hand when checking the brakes so that you can make a brake adjustment if required.

fast fact

Automatic slack adjusters still need to be regularly checked to ensure that correct adjustment is being maintained.

warning!

It's dangerous to manually adjust automatic slack adjusters.

Repeated adjustment can mask other problems and may lead to brake failure.

warning!

Automatic slack adjusters should only be adjusted or repaired by a qualified mechanic.

Follow the manufacturer's instructions in carrying out any adjustment.

It's common, especially on tandem axle units, for the adjusting bolts on one axle to adjust in one direction, while the other axle requires an opposite turn. It's not uncommon to find that the brakes on one or the other axle have been mistakenly backed off, creating a serious safety hazard.

After adjusting, verify that there's enough clearance by re-measuring the free stroke.

S-cam brakes — automatic slack adjuster

All commercial trucks and trailers with air brakes have been manufactured with automatic slack adjusters since 1996. Automatic slack adjusters adjust themselves during normal brake applications made in day-to-day driving.

Automatic slack adjusters are able to maintain brake stroke more reliably than manual slack adjusters. But, automatic slack adjusters must still be checked as part of a pre-trip inspection.

Once properly installed, automatic slack adjusters shouldn't need manual adjustment. If an automatic slack adjuster strokes beyond the maximum allowed, this usually indicates that there are other brake problems that need to be repaired by a qualified brake service mechanic.

Manual adjustment of automatic slack adjusters is dangerous because it gives a false sense of security about the effectiveness of the braking system. A manual adjustment may temporarily shorten the stroke, but the automatic slack will soon re-set to its designed stroke.

Repeated manual adjustment can cause undue wear on the internal components of the slack adjuster and possibly lead to early failure.

Manufacturers generally recommend that automatic slack adjusters be checked by a mechanic at every chassis lubrication interval, every 40,000 km, or every three months, whichever comes first.

The National Safety Code of Canada as well as American and Mexican laws require a daily check of brake adjustment as part of a pre-trip inspection. As well, in certain mountainous areas of North America, signs are posted requiring trucks to stop and check brakes before proceeding down long grades. These brake checks are required regardless of whether manual or automatic slack adjusters are used.

If a pushrod stroke is excessive during one of these checks, the automatic slack adjuster has either failed, been incorrectly installed, or there is a problem within the foundation brake.

Checking and adjusting automatic slack adjusters

Most manufacturers of automatic slack adjusters specify that pushrod stroke be checked by making a 90 to 100 p.s.i. (620 to 690 kPa) application. If you have no application pressure gauge, turn the engine off and pump the reservoir pressure down to between 90 and 100 p.s.i. (620 to 690 kPa) — then make a full application.

driving tip

It's strongly recommended that you get the service data books for the make of automatic slack adjusters that you are using.

They contain all the information needed to keep them operating properly, including lubrication requirements, initial setup, inspection and testing. They're available where truck parts are sold.

warning!

It's dangerous to manually adjust automatic slack adjusters.

The adjustment procedures shown here are for use in emergencies as a last resort where qualified brake personnel can't attend, such as driving the vehicle to a service depot.

Remember — as the driver, you're responsible for the condition of the vehicle you're operating — including the brakes.

Pushrod strokes with automatic slack adjusters are usually slightly longer than with well-adjusted manual slack adjusters. With a typical Type 30 clamp type air chamber and an automatic slack adjuster, the brakes need repair if pushrod measurements are:

- more than $\frac{3}{4}$ of an inch (20 mm) using the pry method of free stroke measurement, or
- more than two inches (50 mm) using the brake application — applied stroke method.

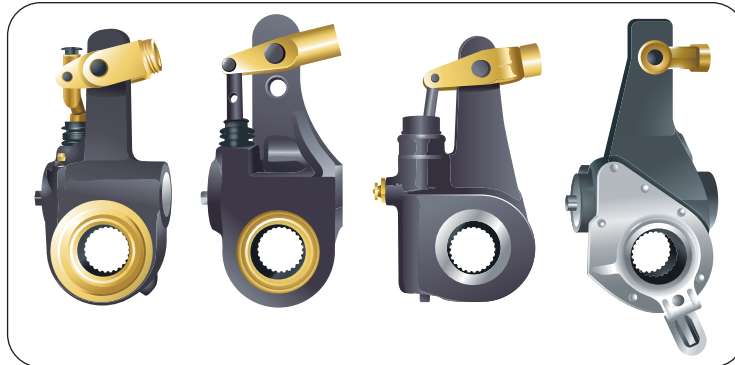

Four types of automatic slack adjusters.

If a pushrod stroke is excessive, the automatic slack adjuster has either failed, been incorrectly installed, or there is a problem within the foundation brake.

THE FOLLOWING ARE EMERGENCY PROCEDURES ONLY. A REPAIR OR REPLACEMENT MUST BE MADE AS SOON AS POSSIBLE.

Be sure that the vehicle is safely parked with the wheels blocked. The air system should be at full pressure and the spring parking brakes released.

If you make an emergency adjustment of an automatic slack adjuster, be sure to record it on your daily post-trip inspection report. After adjusting, verify that there is sufficient clearance by re-measuring the free stroke.

Slack adjusters with hexagonal adjusting bolts

If the slack adjuster has a hexagonal (six-sided) adjusting bolt, the brakes may be set up by turning the adjusting bolt in a **clockwise** direction until the lining contacts the drum. Backing off the adjusting bolt by $\frac{1}{2}$ a turn should restore running clearance. Backing off may take considerable force and you may hear or feel ratcheting. This is normal.

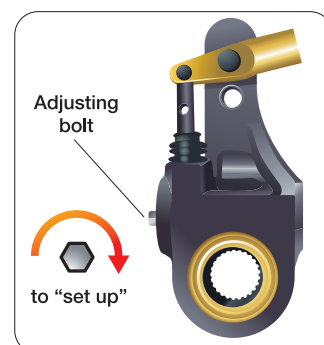
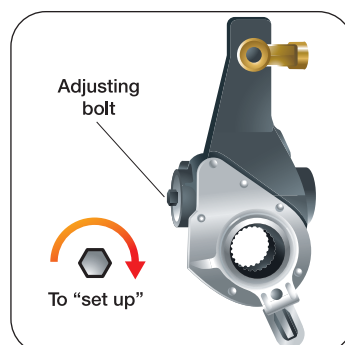

These two types of automatic slack adjusters both have hexagonal adjusting bolts.

fast fact

There's no reliable substitute for physically checking brake adjustment.

Slack adjusters with square adjusting bolts

If the slack adjuster has a square adjusting bolt located at the bottom end of the body, **don't try** adjusting until a spring-loaded pawl that meshes with internal teeth is disengaged. These units have a $\frac{3}{4}$ inch hexagonal (hex) cap located on the slack adjuster body. Some of these hex caps are equipped with a round "button" that can be pried up approximately $\frac{1}{32}$ of an inch (.75 mm) and held, using a screwdriver. On units that don't have the button, the hex cap, spring and pawl must be removed. With the spring and pawl disengaged, you can do the adjustment.

These brakes must be set up with a **counter-clockwise** turn until the lining contacts the drum. Turning the adjusting bolt $\frac{1}{2}$ a turn clockwise will restore running clearance. Release the button or re-install the spring and pawl if you removed them.

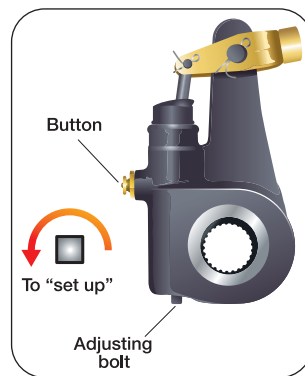

This type of slack adjuster has a square adjusting bolt.

Air brake adjustment myths

There's some misinformation about air brakes that you may hear. These myths could be dangerous, if you believe them.

Myth #1:

Brake adjustment can be checked from the cab by making a full brake application and checking for an initial pressure drop of between 8 to 12 p.s.i. (55.2 to 82.8 kPa). The assumption is that as the brake chambers stroke further and further, that more air volume will be required, and this should show up on the reservoir gauges.

Fact #1:

Modern trucks have very large air reservoirs, and even if all the brakes had excess pushrod travel, the pressure drop would not reach the 8 to 12 p.s.i. (55.2 to 82.8 kPa) range. Also, most truck reservoir gauges don't have fine enough markings to accurately estimate such pressure changes.

Myth #2:

A 90-degree angle between the centre of the slack adjuster arm and the chamber pushrod with the brakes applied is a good indication that the brake is adjusted correctly.

Fact #2:

The 90-degree angle is more dependent on the length of the chamber pushrod than on brake adjustment. Also, to prevent interference between the slack adjuster and suspension parts, some manufacturers will vary the angle up to plus or minus 10 degrees.

Myth #3:

A clockwise turn of the adjusting bolt on a manual slack adjuster will set up the brakes.

Fact #3:

Depending on the orientation of the slack adjuster on the brake assembly, the correct direction to set up the brakes may be clockwise, or counter-clockwise. On vehicles with tandem axles, it's common to find that one axle sets up with a clockwise turn, while the other requires a reverse direction.

Myth #4:

As long as the parking brake control valve is open and the trailer supply valve is open (charged), spring brakes are off and slack adjustment can be checked.

Fact #4:

Some parking brake control valves and trailer supply valves will remain in the open position with as little as 20 p.s.i. (138 kPa) system air pressure. Yet the spring brakes may be partially or fully applied. For this reason, make sure system air pressure is at least 90 to 100 p.s.i. (620 to 690 kPa) and all parking brakes are released before checking brake adjustment.

Myth #5:

Replacing automatic slack adjusters with manual slack adjusters better ensures that the brakes are kept properly adjusted.

Fact #5:

Automatic slack adjusters, as the name implies, automatically adjust for brake wear as the brakes are used. Manual slack adjusters don't adjust for brake wear until they are manually adjusted. A Transport Canada study showed that vehicles with manual slack adjusters were put out-of-service at a rate 150 per cent higher than those with automatic slack adjusters, because there's a higher probability that a brake with a manual slack adjuster would be out of adjustment.

Under B.C. Commercial Vehicle Safety and Enforcement rules, it's illegal to retrofit manual slack adjusters on a vehicle manufactured with automatic slack adjusters.

Review questions

1. Why's it so critical to check slack adjustment?
2. Who's ultimately responsible for the brakes on a vehicle?
3. What's the fine for operating a commercial vehicle with improperly adjusted brakes?
4. What are the dangers of operating a vehicle where the pushrod travel is barely within tolerance when the brake drums are cold?
5. What items should you carry to measure and adjust slack adjusters?
6. What's the first thing you should do when preparing to measure slack adjustment?
7. How much pressure should you apply to the foot valve when measuring slack adjustment using the applied stroke method?
8. How do you know you're turning the adjusting bolt in the correct direction when adjusting a slack adjuster?
9. What's an advantage of automatic slack adjusters?

What you'll learn

After reading this chapter you'll be able to:

- explain the importance of conducting a pre-trip inspection
- explain how to perform an air brake system inspection
- list what to include in required reports
- complete a trip inspection report.

You're responsible

Vehicle manufacturers have done their best to design safe, efficient vehicles. It's the responsibility of the driver to ensure that all the safety features are operating properly.

To ensure that the vehicle you'll be driving is safe, you'll be expected to know how and when to conduct several types of inspections.

If you're applying for a commercial licence or heavy trailer endorsement, you'll be required to conduct a pre-trip inspection as part of your road test.

If the vehicle has air brakes, or if you're applying for an air brake endorsement, you'll be required to conduct a pre-trip inspection of the vehicle's air brake system. If tested on a vehicle equipped with manual slack adjusters, you'll also be required to demonstrate your ability to adjust a brake for proper pushrod travel. If your vehicle has automatic slack adjusters, you'll be asked to explain how to adjust manual slack adjuster brakes for proper pushrod travel.

fast fact

The National Safety Code (NSC) applies to most commercial vehicles and requires the vehicle you'll be driving to be inspected daily.

You're responsible for ensuring your vehicle is safe every time you drive it.

The pre-trip inspection is designed to help you do this.



fast fact

The NSC sets out minimum safety standards for all commercial carriers and drivers operating in Canada.

fast fact

Copies of the NSC regulations that apply in B.C. (found in the *Motor Vehicle Act Regulations*, Division 37 — Safety Code) are available at provincial weigh scales and at www.th.gov.bc.ca/cvse.

fast fact

You may be fined if you fail to carry a trip inspection report. If you operate an unsafe vehicle, you may also be fined and/or your vehicle may be placed out of service.

Vehicle condition

You must determine that your vehicle is in safe operating condition before you drive it. This is part of your job and your responsibility as a professional driver. If you operate your vehicle when it's not safe, you're putting yourself and others at risk.

Taking the time for pre-trip inspections can prevent costly en route delays and reduce the chances of a crash caused by a mechanical failure.

All commercial vehicles that fall under the National Safety Code (NSC) must be inspected before they're used each day (pre-trip inspections) and at the end of the final trip of each day (post-trip inspections). These inspections are required under the *Motor Vehicle Act Regulations*.

Either you or another person specified by the carrier must do these inspections. Both you (the driver) and the carrier share the responsibility to ensure these inspections are done properly.

If you drive any of these vehicles, you must complete daily written inspection reports:

- bus, school bus, special activity bus, special vehicle or limousine with a seating capacity of more than 10 including the driver
- two-axle truck or truck-tractor with a licensed GVW greater than 14,600 kg
- truck or truck-tractor towing a trailer that has a licensed GVW greater than 8,200 kg.

Cargo securement

Under the NSC, all vehicles transporting cargo on a highway regardless of the gross vehicle weight must be inspected for cargo securement.

This includes all articles or materials carried by a vehicle, including those used in its operation.

You must inspect the vehicle prior to driving it to:

- confirm that the equipment used in the vehicle's operations (such as tailgate, tailboard, doors, tarpaulins and spare tire) are secured
- ensure that cargo doesn't interfere with safe operation of the vehicle
- ensure that cargo doesn't interfere with exiting the vehicle, and
- make any necessary adjustments to the cargo and cargo securement system.

Make this a part of your inspection routine.

You must also re-inspect the cargo securement system within 80 km from the point where the cargo was loaded, and on a regular basis during the trip at the earliest of:

- a change in duty status of the driver
- three hours of driving, or
- 240 km of driving since the last inspection.

You're required to record cargo securement inspections on your daily logs. You don't need to inspect cargo if it's sealed and you've been ordered not to inspect it, or if the cargo is inaccessible.

fast fact

All trip inspection reports must be given to the carrier within 20 days.

driving tip

To conduct a pre-trip inspection use:

- a flashlight to inspect components
- tire pressure gauge to check tires
- chalk or other marker, and a ruler or other measuring device to check pushrod free stroke
- a tool to pry on the air brake chamber pushrod to check for free stroke
- a wrench to adjust air brakes
- a watch or other timing device to check air brake leakage and buildup time.

You should also wear sturdy clothing, a hard hat and eye protection.

Written report requirements

Every written trip inspection report must:

- include the licence plate or unit numbers for the commercial vehicle and/or trailers
- specify all defects that may affect the safe operation of the vehicle, or
- state that no defect was discovered, if that was the case
- include the date
- be signed by the person making the report
- be completed prior to the first trip of the day.

If a trip lasts more than one day, new inspection reports must be completed no later than the first rest stop of every subsequent day of the trip.

If you couple to another trailer during the day, you must obtain and carry the trip inspection report completed for that trailer that day. If a trip inspection report for that trailer hasn't been done, you must complete one.

You, or the carrier's agent, must use your written trip inspection report to record all defects found during your trip inspection. For each defect you find, you must state on the form that either the defect has been corrected or that no correction is necessary.

When more than one driver is sharing a vehicle during a trip, only one of the drivers is required to sign the trip inspection report, provided there's no disagreement. All drivers must agree about which, if any, defects are to be reported and how these defects are to be reported (for example, have they been repaired or whether they need immediate repair).

If there's a disagreement over the defects to be reported, all drivers must sign and indicate the nature of the disagreement.

Some commercial vehicle drivers are exempt from completing written trip reports. To learn whether this exemption applies to you, refer to Division 37 of the *Motor Vehicle Act Regulations*, which sets out B.C.'s requirements for trip inspections.

Pre-trip inspection report for your road test

During the pre-trip portion of your road test, your driver examiner will give you a copy of the trip inspection report form found on the next page.

This sample has been filled in as if a driver had found some minor defects during a pre-trip inspection. In this case, the driver also filled out the Carrier/Agent's Report. The report shows that all defects that could have made the vehicle unsafe have been fixed. The driver signed the report to say the vehicle is now safe to use. If the vehicle had no defects, the Carrier/Agent's Report section would have been left blank.

Your driver examiner will give you a blank form to complete and return during your test. Part of your grade will be based on how completely and accurately you fill out this trip inspection report.

fast fact

If any defect was identified and repaired during your pre-trip inspection, your report must note the defect and show a signature that certifies the defect was corrected.

If a defect does not affect you operating your vehicle safely, repairs may wait but the defect must still be recorded and it must be noted that the defect doesn't require immediate repair.

warning!

You may not be able to safely inspect all components on vehicles with low ground clearance or air suspension. The components that you can't inspect or access should be checked by a mechanic as part of regular preventative maintenance of your vehicle.

Pre-trip Inspection Test sample report



2222222
DRIVER'S LICENCE NO.

TRIP INSPECTION REPORT

Type of Inspection: Pre-trip Inspection Post-trip Inspection

Bus/Truck/Tractor # 409 **Odometer Reading** 87654 Km Miles

I detected no defect or deficiency in this commercial motor vehicle.
 I found the following defects as noted below:

<input type="checkbox"/> Air Compressor <input type="checkbox"/> Air Lines <input type="checkbox"/> Axles <input type="checkbox"/> Battery(s) <input type="checkbox"/> Belts/Hoses <input type="checkbox"/> Body/Frame <input checked="" type="checkbox"/> Brakes/Adjustment <input type="checkbox"/> Brakes - Service System <input type="checkbox"/> Brakes - Parking System <input type="checkbox"/> Charging System <input type="checkbox"/> Clutch <input type="checkbox"/> Cooling System <input type="checkbox"/> Coupling Devices <input type="checkbox"/> Documents (insurance, permits, etc.) <input type="checkbox"/> Doors/Compartments	<input type="checkbox"/> Drive Lines <input type="checkbox"/> Emergency Equipment <input type="checkbox"/> Emergency Windows/Exits <input type="checkbox"/> Engine <input type="checkbox"/> Exhaust System <input type="checkbox"/> Fire Extinguishers <input type="checkbox"/> First Aid Kit <input type="checkbox"/> Fluid Leaks <input type="checkbox"/> Frame <input type="checkbox"/> Fuel System <input type="checkbox"/> Heaters/Defrosters <input type="checkbox"/> Horns <input type="checkbox"/> Inspection Decal/Licence Plates <input type="checkbox"/> Interior Lights <input type="checkbox"/> Lights/Reflectors	<input type="checkbox"/> Load Security Devices <input type="checkbox"/> Lubrication System(s) <input type="checkbox"/> Mirrors <input type="checkbox"/> Mud Flaps <input type="checkbox"/> Oil Pressure <input type="checkbox"/> Rear End <input type="checkbox"/> Recording Device(s) <input type="checkbox"/> Seats <input type="checkbox"/> Suspension <input type="checkbox"/> Steering Mechanism <input type="checkbox"/> Transmission(s) <input type="checkbox"/> Wheels/Tires/Studs <input type="checkbox"/> Windows/Visibility <input type="checkbox"/> Wipers/Washers <input checked="" type="checkbox"/> Other
---	--	--

Trailer(s) #1 54 **#2** _____

<table border="0" style="width: 100%;"> <tr><th>#1</th><th>#2</th></tr> <tr><td><input type="checkbox"/></td><td><input type="checkbox"/></td></tr> <tr><td><input type="checkbox"/> Air Lines/Glad Hands</td><td><input type="checkbox"/> Coupling - Kingpin</td></tr> <tr><td><input type="checkbox"/> Axles</td><td><input type="checkbox"/> Doors/Compartments</td></tr> <tr><td><input type="checkbox"/> Body/Frame</td><td><input type="checkbox"/> Inspection Decal/Plates</td></tr> <tr><td><input type="checkbox"/> Brakes/Adjustment</td><td><input type="checkbox"/> Landing Gear</td></tr> <tr><td><input type="checkbox"/> Coupling Devices</td><td><input checked="" type="checkbox"/> Lights/Reflectors</td></tr> </table>	#1	#2	<input type="checkbox"/>	<input type="checkbox"/>	<input type="checkbox"/> Air Lines/Glad Hands	<input type="checkbox"/> Coupling - Kingpin	<input type="checkbox"/> Axles	<input type="checkbox"/> Doors/Compartments	<input type="checkbox"/> Body/Frame	<input type="checkbox"/> Inspection Decal/Plates	<input type="checkbox"/> Brakes/Adjustment	<input type="checkbox"/> Landing Gear	<input type="checkbox"/> Coupling Devices	<input checked="" type="checkbox"/> Lights/Reflectors	<table border="0" style="width: 100%;"> <tr><th>#1</th><th>#2</th></tr> <tr><td><input type="checkbox"/></td><td><input type="checkbox"/></td></tr> <tr><td><input type="checkbox"/> Load Security/Dunnage</td><td><input type="checkbox"/> Mud Flaps</td></tr> <tr><td><input type="checkbox"/> Suspension</td><td><input type="checkbox"/> Wheels/Tires/Studs</td></tr> <tr><td><input type="checkbox"/> Other</td><td><input type="checkbox"/></td></tr> </table>	#1	#2	<input type="checkbox"/>	<input type="checkbox"/>	<input type="checkbox"/> Load Security/Dunnage	<input type="checkbox"/> Mud Flaps	<input type="checkbox"/> Suspension	<input type="checkbox"/> Wheels/Tires/Studs	<input type="checkbox"/> Other	<input type="checkbox"/>
#1	#2																								
<input type="checkbox"/>	<input type="checkbox"/>																								
<input type="checkbox"/> Air Lines/Glad Hands	<input type="checkbox"/> Coupling - Kingpin																								
<input type="checkbox"/> Axles	<input type="checkbox"/> Doors/Compartments																								
<input type="checkbox"/> Body/Frame	<input type="checkbox"/> Inspection Decal/Plates																								
<input type="checkbox"/> Brakes/Adjustment	<input type="checkbox"/> Landing Gear																								
<input type="checkbox"/> Coupling Devices	<input checked="" type="checkbox"/> Lights/Reflectors																								
#1	#2																								
<input type="checkbox"/>	<input type="checkbox"/>																								
<input type="checkbox"/> Load Security/Dunnage	<input type="checkbox"/> Mud Flaps																								
<input type="checkbox"/> Suspension	<input type="checkbox"/> Wheels/Tires/Studs																								
<input type="checkbox"/> Other	<input type="checkbox"/>																								

Remarks: Adjusted left brake on rear axle
Replaced left rear taillight
Fuel gauge not working – not corrected

Inspector: Dave Driver January 10, 2011 9:10 AM PM
SIGNATURE OF PERSON INSPECTING VEHICLE DATE TIME

Carrier/Agent's Report
 Above defects corrected.
 Above defects need not be corrected for safe operation of vehicle.

Carrier: Dave Driver January 10, 2011 9:10 AM PM
SIGNATURE DATE TIME
Driver
TITLE

MV2930 (022009)

driving tip

By conducting a good pre-trip inspection, you can avoid dangerous situations and legal and job-related consequences.

Conducting a pre-trip inspection

The following pages show detailed pre-trip inspection procedures for a Class 1 tractor-trailer combination including air brakes, a Class 2 or 4 — unrestricted bus, a Class 3 single-unit truck including air brakes and a Class 4 taxi. The various pre-trip inspections are colour-coded for ease of reference.

If you're applying only for an air brake endorsement, you'll need to complete an air brake pre-trip inspection. **The air brake inspection portions of the Class 1 and 3 pre-trip inspections are shown in red.**

Study and practise the one that applies to the class of licence or endorsement you're working toward. Practise your pre-trip inspection on the vehicle you bring for your road test.

The procedures included here are guidelines for you to follow during your road test. Your vehicle may require you to check different items than those listed. Each pre-trip inspection has been given an allotted time. You should be able to complete your inspection within that time.

You may conduct a pre-trip inspection in any order, but you should get in the habit of conducting it in the same order every time to avoid missing items. The pre-trip inspections shown on the next pages show a good order to follow. They begin with checking under the hood, then walking around the vehicle to do a circle check to inspect certain items, then getting into the cab to check gauges, etc. The final step is to pull ahead slowly to check for brake and steering response.

Before you begin

- Choose a safe location to park your vehicle away from traffic. Park on level ground if possible.
- Set the parking brakes. Shut off the engine.
- If it's a large commercial vehicle, block the wheels securely by placing a block in front of and behind the tire on the same axle of the tractor. Ensure the blocks will keep your vehicle from moving.
- You should walk in a counter-clockwise direction when you do the circle check, so you're facing oncoming traffic.



Tractor-trailer combination pre-trip inspection — Class 1

You should be able to complete this pre-trip inspection in less than 45 minutes.

You must demonstrate your ability to set up a slack adjuster during your pre-trip inspection test. Refer to **chapter 9, air brake adjustment** for more information on setting up slack adjusters.

If you're applying for a heavy trailer endorsement (code 20), follow the Class 1 pre-trip inspection, deleting the air brake inspection steps.

fast fact

As part of your road test, Class 1 pre-trip inspection, you'll be tested on your ability to complete a pre-trip inspection. If the vehicle has air brakes with manual slack adjusters, you'll also be tested on your ability to perform a brake adjustment.

You should assume that the vehicle hasn't been operated on the day of your test and that a pre-trip inspection hasn't been done. During the test, point to or touch the things you're inspecting, and tell the driver examiner what you're looking for: for example, "I'm checking the front clearance lights to make sure they work, the lenses are clean and not cracked, and for correct colour."

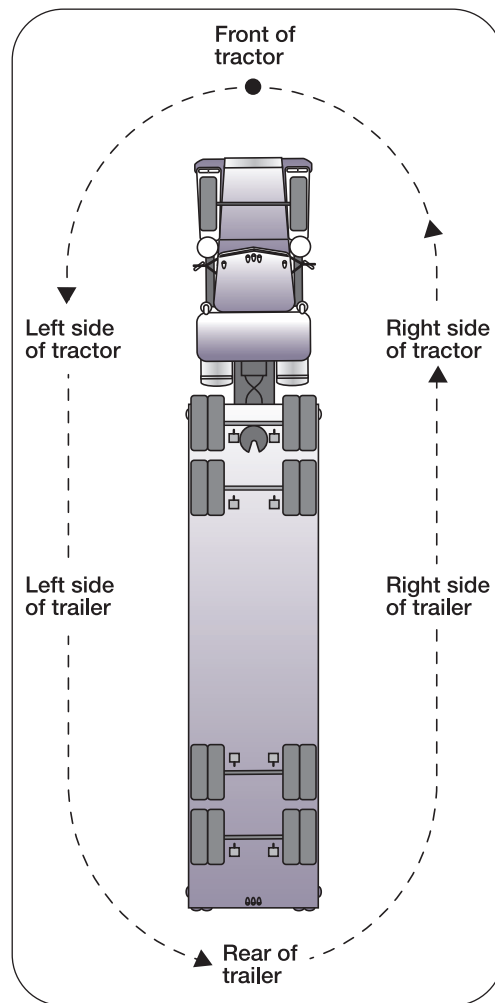

Before you begin:

- set the parking brakes
- shut off the engine
- block the wheels.

**Class 1
pre-trip inspection**

driving tip

It's often easier to spot leaks and body damage as you approach your vehicle than when you're right beside it.

fast fact

All reservoirs should be drained daily.

It can be hard to tell the supply reservoir from the primary and secondary reservoirs. Checking the air pressure gauges while draining the reservoirs may help you to tell which reservoir is which.

driving tip

As you're circling the vehicle conducting the pre-trip inspection, check each tire, wheel and mud flap. Also check suspension and frame, brake lines, brake chambers and slack adjusters. Measure air brake chamber pushrod travel.

Also remove the keys from the ignition to ensure that nobody tries to move the vehicle while you're checking underneath.

1. Under hood

As you approach, look under the vehicle for leaks.

Drain the reservoirs (for your road test, you're only required to drain the supply reservoir).

Check the following:

<input type="checkbox"/> Licence plate	<ul style="list-style-type: none"> • check for licence plate and valid decal
<input type="checkbox"/> Fluids	<ul style="list-style-type: none"> • check fluid levels and condition (for example, colour, smell) including: engine oil, engine coolant, power steering fluid and windshield washer fluid
<input type="checkbox"/> Belts	<ul style="list-style-type: none"> • ensure any drive belts have good tension with no cracks, frayed cord or missing teeth
<input type="checkbox"/> Hoses	<ul style="list-style-type: none"> • ensure hose connections are secure with no kinks, leaks, cuts, abrasions or cracks
<input type="checkbox"/> Compressor	<ul style="list-style-type: none"> • ensure lines are securely attached with no kinks, leaks, cuts or abrasions • compressor is securely mounted
<input type="checkbox"/> Steering components	<ul style="list-style-type: none"> • check steering shaft, steering box, tie-rods, idler arm and connections • ensure they're secure • no bends or cracks
<input type="checkbox"/> Suspension	<p>As you inspect the vehicle, check the suspension at all wheels:</p> <ul style="list-style-type: none"> • ensure there are no cracked, missing or broken springs, torsion bars or walking beams • no loose, missing or broken U-bolts • if air suspension, no cracked, worn or inoperative airbags • mounts are secure
<input type="checkbox"/> Frame	<p>As you inspect the vehicle, check the frame:</p> <ul style="list-style-type: none"> • ensure there are no cracks, broken welds, holes or other damage to the frame including cross members and floor

**Class 1
pre-trip inspection**

fast fact
A peace officer may place your vehicle out of service if drum brake linings are less than 1/4 inch (6.4 mm) thick or air disc brake pads are less than 1/8 inch (3.2 mm) thick.

<p><input type="checkbox"/> Tires/wheels/mud flaps</p>	<p>As you inspect the vehicle, check all tires, wheels and mud flaps:</p> <ul style="list-style-type: none"> • check tires for inflation, signs of bulges, sidewall separation, cuts to cord, exposed or frayed belts • adequate tread depth • tire wear is even • duals aren't touching and nothing is stuck between them • check wheels/rims for cracks, missing pieces or bends • ensure wheel lugs and nuts are secure, not missing, broken or loose (rust streaks may indicate loose wheel nuts) • with spoke wheels, also check that rims are securely fastened to the spokes (polished or shiny areas at flanges or clamps may indicate rim slippage from loose fasteners) • check wheel hub oil level by viewing through sight glass (if present) • check that mud flaps are secure • mud flaps don't rub tires
<p><input type="checkbox"/> Foundation brakes</p>	<p>As you inspect the vehicle, check each foundation brake including brake chambers, slack adjusters, air hoses, s-cams, brake drums and linings:</p> <ul style="list-style-type: none"> • brake chamber mounting and retention clamps are secure • no signs of cracks, corrosion or holes • nothing will obstruct the mechanism • no audible air leaks • pushrod travel is within tolerance • check slack adjuster, s-cam and bushings for mechanical condition and wear • air lines are secure • no leaks, abrasions, cuts or cracks • no kinks • brake drums aren't cracked or broken • linings or drums not contaminated • lining thickness is within tolerance (if visible)

Close and secure hood.

Close supply reservoir.

2. In cab

Turn ignition to the "on" position. Check the following:

<p><input type="checkbox"/> Gauges/warning lights</p>	<ul style="list-style-type: none"> • check oil pressure warning light or gauge
--	---

Depress clutch, shift transmission to neutral and start engine.

**Class 1
pre-trip inspection**

While air pressure is building, check the following:

<input type="checkbox"/> Air pressure gauges	<ul style="list-style-type: none"> • check gauges to confirm that only the supply reservoir air was drained (if other reservoirs have lost pressure, this may indicate that a one-way check valve is not functioning)
<input type="checkbox"/> Instrument panel	<p>Ensure that all gauges and warning lights are working properly, and that they respond properly as the engine warms up:</p> <ul style="list-style-type: none"> • charge rate indicator or gauge — ensure voltmeter or ammeter works properly and the charge is good • oil pressure indicator or gauge — ensure that it indicates normal pressure soon after engine starts • coolant temperature indicator or gauge — check that indicator rises to normal operating temperature — light should go off after engine starts • fuel gauge — ensure it's working properly — indicates sufficient fuel • instrument lights — ensure they work
<input type="checkbox"/> Windshield wipers/washers	<ul style="list-style-type: none"> • ensure wipers and washers work
<input type="checkbox"/> Heater/defroster	<ul style="list-style-type: none"> • ensure heater and defroster controls work including fan, in heater and defroster positions
<input type="checkbox"/> Interior lights	<ul style="list-style-type: none"> • ensure they work
<input type="checkbox"/> Horns (air and electric)	<ul style="list-style-type: none"> • ensure they work
<input type="checkbox"/> Emergency equipment	<ul style="list-style-type: none"> • warning devices — ensure they're in working condition • fire extinguisher (if required or present) — ensure the date on the label is valid
<input type="checkbox"/> Four-way flashers	<ul style="list-style-type: none"> • check that both indicators on dashboard work (the exterior lights will be checked later as part of checking the turn signals)
<input type="checkbox"/> Seats, seatbelts	<ul style="list-style-type: none"> • ensure driver's seat and seatbelt are adjusted for you • fastening devices are in working order and accessible

Class 1
pre-trip inspection

driving tip

On some air brake systems, one service reservoir may begin to fill first. When pressure reaches approximately 85 to 95 p.s.i., (586 to 655 kPa) the other reservoir will begin to fill, then pressure in both service reservoirs will build to full pressure.

Regardless of the type of system, pressure must build from 50 to 90 p.s.i. (345 to 620 kPa) within three minutes.

<input type="checkbox"/> Mirrors	<ul style="list-style-type: none"> ensure they're adjusted for you and are clean and free of cracks
<input type="checkbox"/> Windows/windshield	<ul style="list-style-type: none"> ensure they're clean and free of cracks and that they open and close
<input type="checkbox"/> Documentation	<p>Ensure that all documentation is in the vehicle, valid and up-to-date including:</p> <ul style="list-style-type: none"> vehicle licence, registration and insurance (including trailers) logbook (if required) CVIP inspection report (if required) CVIP inspection decal on windshield (if required)
<input type="checkbox"/> Engine noises	<ul style="list-style-type: none"> listen for unusual sounds

Check that compressor stops pumping between 105 and 135 p.s.i. (724 and 931 kPa).

Release all parking brakes and charge trailer air system.

3. Air brake system test

Start lowering the air pressure by pumping the brake pedal.

Perform these steps:

1. Pump down to approximately 80 per cent of maximum pressure (for example, if maximum is 125 p.s.i., pump down to 100 p.s.i.). Pause and check that air pressure begins to build (to confirm governor cut-in pressure). In all cases, the governor must cause the compressor to cut in before pressure falls below 80 p.s.i. (552 kPa).
2. Pump down farther. Check that low-air warning device(s) activate at or above 60 p.s.i. (414 kPa).
3. Pump down farther. Check that trailer air supply valve closes when the highest reservoir pressure gauge reads between 20 to 45 p.s.i. (138 to 310 kPa).
Note: Parking brake control valve may — or may not — also close.
4. Shut off engine.
5. Go to trailer. Check to ensure that trailer brakes have applied.
6. Go to the rear of the tractor. Disconnect supply and control line glad hands. Check that no air escapes from either the tractor or the trailer through the glad hands.
7. Go to cab. Make a foot brake application. Listen to ensure that no air escapes through either the supply line or control line.
8. Exit cab. Reconnect supply and control line glad hands. Also check trailer electrical connection, and that air and electrical lines aren't damaged, tangled, or chafing, and that there's sufficient slack for turns.

Go to cab.

Start engine.

9. Check that air reservoir pressure builds from 50 to 90 p.s.i. (345 to 620 kPa) within three minutes at a fast idle (1,000 to 1,200 r.p.m.).

**Class 1
pre-trip inspection**

driving tip

Carry a rag with you to wipe all lenses as you make sure the lights are working. Also use it to clean reflective tape to make sure it's visible to other road users.

fast fact

Typical emergency equipment on a commercial vehicle includes:

- flags or flares
- first aid kit
- fire extinguisher.

4. Circle check for lights

Turn on left turn signal, low-beam headlights and clearance lights.

Conduct circle check by walking counter-clockwise to face traffic. Be particularly cautious when you're walking with your back to traffic.

Lights

As you inspect the vehicle, check all lights:

- ensure they work
- lenses are clean and not cracked
- lenses are correct colour

1. Check left-turn signals, low-beam headlights, tail lights, licence plate lights and clearance lights.

Return to cab.

Turn off left turn signal. Turn on high-beam headlights and right-turn signal.

2. Check that right-turn signal and high-beam headlights are working.
3. Check that brake lights are working.

Turn off lights.

Release all parking brakes.

Turn off engine.

5. Mechanical circle check

Leave cab and begin circle check.

Left side of tractor

<input type="checkbox"/> Mirrors	<ul style="list-style-type: none"> • ensure they're securely attached
<input type="checkbox"/> Steps and hand rails	<ul style="list-style-type: none"> • ensure they're secure
<input type="checkbox"/> Fuel tanks	<ul style="list-style-type: none"> • ensure tanks, fuel caps and fuel lines are securely fastened
<input type="checkbox"/> Exhaust system	<ul style="list-style-type: none"> • ensure it's in good condition • no leaks • mufflers, pipes and shields securely fastened
<input type="checkbox"/> Battery compartments	<ul style="list-style-type: none"> • batteries securely fastened to battery compartment and battery compartments securely fastened • no corrosion on batteries • no battery leaks • battery cables secure
<input type="checkbox"/> Storage compartments	<ul style="list-style-type: none"> • ensure compartments are securely fastened • doors open and close properly • contents are secure
<input type="checkbox"/> Body	<ul style="list-style-type: none"> • check for body damage

**Class 1
pre-trip inspection**

<input type="checkbox"/> Frame	<ul style="list-style-type: none"> • check frame
<input type="checkbox"/> Fifth wheel connection	<ul style="list-style-type: none"> • plate is flush to the trailer apron (no daylight is visible between fifth wheel and apron) • ensure slider is locked and secure with sufficient space for trailer to turn without striking tractor • locking jaws are closed around trailer kingpin
<input type="checkbox"/> Other type of trailer connection	<ul style="list-style-type: none"> • ensure pintle hitch or ball hitch is not worn • locking mechanism is closed and secure • chains or cables (if equipped) have no stress cracks or weld breaks and are securely attached to truck and trailer
<input type="checkbox"/> Suspension	<ul style="list-style-type: none"> • check tractor rear suspension
<input type="checkbox"/> Tires/wheels/mud flaps	<ul style="list-style-type: none"> • check tractor drive wheels
<input type="checkbox"/> Cargo lift (if equipped)	<ul style="list-style-type: none"> • fully retracted • securely latched • no leaks, or damaged or missing parts
<input type="checkbox"/> Cab protector (if equipped)	<ul style="list-style-type: none"> • secure to frame • free of damage
<input type="checkbox"/> Licence plate	<ul style="list-style-type: none"> • check for licence plate

Left side of trailer

<input type="checkbox"/> Load security devices	<ul style="list-style-type: none"> • load is secured • adequate load security devices are in place and are tight
<input type="checkbox"/> Landing gear	<ul style="list-style-type: none"> • fully raised • no missing parts • crank handle is secured
<input type="checkbox"/> Frame	<ul style="list-style-type: none"> • check frame
<input type="checkbox"/> Suspension	<ul style="list-style-type: none"> • check trailer suspension including sliding axle assembly (if equipped)
<input type="checkbox"/> Tires/wheels/mud flaps	<ul style="list-style-type: none"> • check trailer wheels
<input type="checkbox"/> Trailer body	<ul style="list-style-type: none"> • check for body damage

**Class 1
pre-trip inspection**

driving tip

Make sure the load you're carrying is secure.

Rear of trailer

<input type="checkbox"/> Load security devices	• load is secured • adequate load security devices are in place and are tight
<input type="checkbox"/> Licence plate	• check for licence plate and valid decal

Open trailer rear doors (if applicable).

<input type="checkbox"/> Cargo	• load is secured • adequate load security devices are in place and are tight
<input type="checkbox"/> Trailer doors/ lift/ tailgate	• doors are securely mounted • securely closed or latched • lift is fully retracted • lift has no leaks, damage or missing parts

Right side of trailer

<input type="checkbox"/> Load security devices	• load is secured • adequate load security devices are in place and are tight
<input type="checkbox"/> Frame	• check frame
<input type="checkbox"/> Suspension	• check trailer suspension including sliding axle assembly (if equipped)
<input type="checkbox"/> Tires/wheels/mud flaps	• check trailer wheels
<input type="checkbox"/> Trailer body	• check for body damage • check for CVIP inspection decal

Underside of tractor and trailer

<input type="checkbox"/> Foundation brakes	• check brakes
<input type="checkbox"/> Axle assembly	• ensure there are no breaks, bends, cracks, holes, broken seals or leaks • securely fastened to tractor or trailer
<input type="checkbox"/> Frame	• check frame
<input type="checkbox"/> Tanks	• ensure any tanks such as air reservoirs are securely mounted
<input type="checkbox"/> Suspension	• check tractor and trailer suspension including trailer sliding axle assembly (if equipped)
<input type="checkbox"/> Drive line	• check u-joints for free play • check for leaks

driving tip

Check brake adjustment when you're underneath the truck and trailer.

Class 1
pre-trip inspection

Right side of tractor

<input type="checkbox"/> Mirrors	<ul style="list-style-type: none"> • ensure they're securely attached
<input type="checkbox"/> Steps and hand rails	<ul style="list-style-type: none"> • ensure they're secure
<input type="checkbox"/> Fuel tanks	<ul style="list-style-type: none"> • ensure tanks, fuel caps and fuel lines are securely fastened
<input type="checkbox"/> Exhaust system	<ul style="list-style-type: none"> • ensure it's in good condition • no leaks • mufflers, pipes and shields are securely fastened
<input type="checkbox"/> Battery compartments	<ul style="list-style-type: none"> • batteries securely fastened to battery compartment and compartments securely fastened • no corrosion on batteries • no battery leaks • battery cables secure
<input type="checkbox"/> Storage compartments	<ul style="list-style-type: none"> • ensure compartments are securely fastened • doors open and close properly • contents are secure
<input type="checkbox"/> Body	<ul style="list-style-type: none"> • check for body damage • check for valid CVIP inspection decal
<input type="checkbox"/> Frame	<ul style="list-style-type: none"> • check frame
<input type="checkbox"/> Fifth wheel connection	<ul style="list-style-type: none"> • plate is flush to the trailer apron (no daylight is visible between fifth wheel and apron) • ensure slider is locked and secure • locking jaws are closed around trailer kingpin
<input type="checkbox"/> Other type of trailer connection	<ul style="list-style-type: none"> • ensure pintle hitch or ball hitch is not worn • locking mechanism is closed and secure • chains or cables (if equipped) have no stress cracks or weld breaks and are securely attached to truck and trailer
<input type="checkbox"/> Suspension	<ul style="list-style-type: none"> • check tractor rear suspension
<input type="checkbox"/> Tires/wheels/mud flaps	<ul style="list-style-type: none"> • check tractor drive wheels

driving tip

Use a flashlight to check the fifth wheel connection from both the left and right sides of the tractor, and from underneath the trailer.

Return to cab.

Check that air pressure is at least 100 p.s.i. (690 kPa).

Check that parking brakes are released.

Class 1 pre-trip inspection

driving tip

Check for air leakage with the engine off. This allows you to listen for leaks.

driving tip

Make sure the spring brakes are released before making a heavy brake application to avoid compounding the brakes.

Make a full brake application (90 to 100 p.s.i., 620 to 690 kPa) and hold it for one minute:

- *Check to ensure that, after the initial pressure drop, air loss is not more than 4 p.s.i. (27.6 kPa) per minute. 6 p.s.i. (41.4 kPa) per minute with two trailers.*
- *Check that there are no audible air leaks.*

Set parking brakes. Remove wheel blocks.

6. Brake response, tug and steering wheel slack tests

Perform these steps:

1. Depress clutch. Shift transmission into neutral and start engine.
2. Ensure air pressure is up to operating range.
3. Release tractor parking brakes and apply the trailer brakes.
4. In low gear, gently tug against the trailer parking brakes. The brakes should prevent the combination from moving.
5. Apply the tractor parking brakes. Open the trailer supply valve to charge the trailer and release the trailer brakes.
6. In low gear, gently tug against the tractor parking brakes. The brakes should prevent the combination from moving.
7. Release all brakes.
8. Move the vehicle ahead slowly and gently apply the foot brake to check brake response.
9. Move the vehicle ahead slowly and gently apply the hand valve to check trailer brake response.
10. Move the steering wheel to check for excessive slack or lash (play).

Note: If the trailer isn't equipped with air brakes, check that the trailer brakes will apply in a trailer breakaway situation. For most electric trailer brakes, this can be checked by disconnecting the trailer electrical cable. Then, pull the pin from the trailer breakaway switch housing, and check that the trailer brakes have applied. Then reinstall the pin in the trailer breakaway switch housing and reconnect the trailer electrical cable.

Inspecting double trailers

Inspect double trailers and their couplers and air brake systems in the same way as the preceding inspection.

Single unit truck pre-trip inspection — Class 3

The next pages detail the suggested pre-trip inspection of a truck with air brakes.

You should be able to complete this pre-trip inspection in less than 30 minutes.

If the truck you're using is equipped with air brakes, you must demonstrate your ability to set up a slack adjuster during your pre-trip inspection test. Refer to **chapter 9, air brake adjustment** for more information.

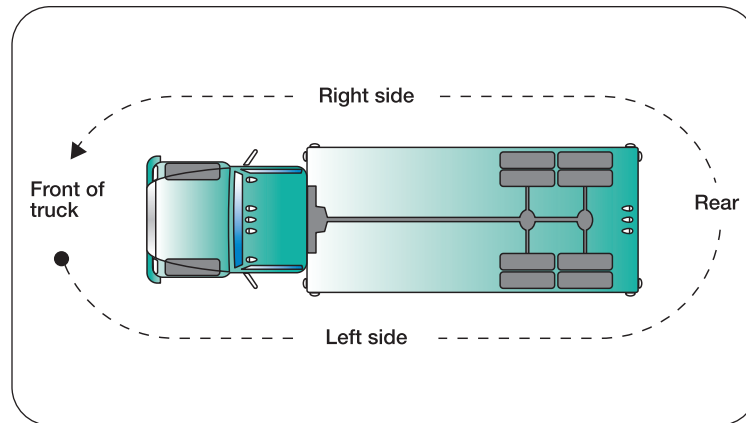

Before you begin:

- set the parking brakes
- shut off the engine
- block the wheels.

**Class 3
pre-trip inspection**

driving tip

It's often easier to spot leaks and body damage as you approach your vehicle than when you're right beside it.

fast fact

All reservoirs should be drained daily.

It can be hard to tell the supply reservoir from the primary and secondary reservoirs. Checking the air pressure gauges while draining the reservoirs may help you to tell which reservoir is which.

driving tip

As you circle the vehicle conducting the pre-trip inspection, check each tire, wheel and mud flap. Also, check suspension and frame, brake lines, brake chambers and slack adjusters. Measure air brake chamber pushrod travel.

Also, remove the keys from the ignition to ensure that nobody tries to move the vehicle while you're checking underneath.

1. Under hood

As you approach, look under the vehicle for leaks.

Drain the reservoirs (for your road test, you're only required to drain the supply reservoir).

Check the following:

<input type="checkbox"/> Licence plate	<ul style="list-style-type: none"> • check for licence plate and valid decal
<input type="checkbox"/> Fluids	<ul style="list-style-type: none"> • check fluid levels and condition (for example, colour, smell) including: engine oil, engine coolant, power steering fluid and windshield washer fluid
<input type="checkbox"/> Belts	<ul style="list-style-type: none"> • ensure any drive belts have good tension with no cracks, frayed cord or missing teeth
<input type="checkbox"/> Hoses	<ul style="list-style-type: none"> • ensure hose connections are secure with no kinks, leaks, cuts, abrasions or cracks
<input type="checkbox"/> Compressor	<ul style="list-style-type: none"> • ensure lines are securely attached with no kinks, leaks, cuts or abrasions • compressor is securely mounted
<input type="checkbox"/> Steering components	<ul style="list-style-type: none"> • check steering shaft, steering box, tie-rods, idler arm and connections • ensure they're secure • no bends or cracks
<input type="checkbox"/> Suspension	<p>As you inspect the vehicle, check the suspension at all wheels:</p> <ul style="list-style-type: none"> • ensure there are no cracked, missing or broken springs, torsion bars or walking beams • no loose, missing or broken U-bolts • if air suspension, no cracked, worn or inoperative airbags • mounts are secure
<input type="checkbox"/> Frame	<p>As you inspect the vehicle, check the frame:</p> <ul style="list-style-type: none"> • ensure there are no cracks, broken welds, holes or other damage to the frame including cross members and floor

**Class 3
pre-trip inspection**

fast fact

A peace officer may place your vehicle out of service if drum brake linings are less than 1/4 inch (6.4 mm) thick or air disc brake pads are less than 1/8 inch (3.2 mm) thick.

☐ Tires/wheels/mud flaps

As you inspect the vehicle, check all tires, wheels and mud flaps:

- check tires for inflation, signs of bulges, sidewall separation, cuts to cord, exposed or frayed belts • adequate tread depth
- tire wear is even • duals aren't touching and nothing is stuck between them
- check wheels/rims for cracks, missing pieces or bends • ensure wheel lugs and nuts are secure, not missing, broken or loose (rust streaks may indicate loose wheel nuts) • with spoke wheels, also check that rims are securely fastened to the spokes (polished or shiny areas at flanges or clamps may indicate rim slippage from loose fasteners)
- check wheel hub oil level by viewing through sight glass (if present)
- check that mud flaps are secure • mud flaps don't rub tires

☐ Foundation brakes

As you inspect the vehicle, check each foundation brake including brake chambers, slack adjusters, air hoses, s-cams, brake drums and linings:

- brake chamber mounting and retention clamps are secure • no signs of cracks, corrosion or holes • nothing will obstruct the mechanism • no audible air leaks
- pushrod travel is within tolerance • check slack adjuster, s-cam and bushings for mechanical condition and wear
- air lines are secure • no leaks, abrasions, cuts or cracks • no kinks
- brake drums aren't cracked or broken
- linings or drums not contaminated • lining thickness is within tolerance (if visible)

Close and secure hood.

Close supply reservoir.

2. In cab

Turn ignition to the "on" position. Check the following:

☐ Gauges/warning lights

- check oil pressure warning light or gauge

Depress clutch, shift transmission to neutral and start engine.

**Class 3
pre-trip inspection**

While air pressure is building, check the following:

<input type="checkbox"/> Air pressure gauges	<ul style="list-style-type: none"> • check gauges to confirm that only the supply reservoir air was drained (if other reservoirs have lost pressure, this may indicate that a one-way check valve isn't functioning)
<input type="checkbox"/> Instrument panel	<p>Ensure that all gauges and warning lights are working properly, and that they respond properly as the engine warms up:</p> <ul style="list-style-type: none"> • charge rate indicator or gauge — ensure voltmeter or ammeter works properly and the charge is good • oil pressure indicator or gauge — ensure that it indicates normal pressure soon after engine starts • coolant temperature indicator or gauge — check that indicator rises to normal operating temperature — light should go off after engine starts • fuel gauge — ensure it's working properly — indicates sufficient fuel • instrument lights — ensure they work
<input type="checkbox"/> Windshield wipers/washers	<ul style="list-style-type: none"> • ensure wipers and washers work
<input type="checkbox"/> Heater/defroster	<ul style="list-style-type: none"> • ensure heater and defroster controls work including fan, in heater and defroster positions
<input type="checkbox"/> Interior lights	<ul style="list-style-type: none"> • ensure they work
<input type="checkbox"/> Horns (air and electric)	<ul style="list-style-type: none"> • ensure they work
<input type="checkbox"/> Emergency equipment	<ul style="list-style-type: none"> • warning devices — ensure they're in working condition • fire extinguisher (if required or present) — ensure the date on the label is valid
<input type="checkbox"/> Four-way flashers	<ul style="list-style-type: none"> • check that both indicators on dashboard work (the exterior lights will be checked later as part of checking the turn signals)
<input type="checkbox"/> Engine noises	<ul style="list-style-type: none"> • listen for unusual sounds

**Class 3
pre-trip inspection**

<input type="checkbox"/> Seats, seatbelts	<ul style="list-style-type: none"> • ensure driver's seat and seatbelt are adjusted for you • fastening devices are in working order and accessible
<input type="checkbox"/> Mirrors	<ul style="list-style-type: none"> • ensure they're adjusted for you and are clean and free of cracks
<input type="checkbox"/> Windows/windshield	<ul style="list-style-type: none"> • ensure they're clean and free of cracks and that they open and close
<input type="checkbox"/> Documentation	<p>Ensure that all documentation is in the vehicle, valid and up-to-date including:</p> <ul style="list-style-type: none"> • vehicle licence, registration and insurance • logbook (if required) • CVIP inspection report (if required) • CVIP inspection decal on windshield (if required)

Check that the compressor stops pumping between 105 and 135 p.s.i. (724 and 931 kPa).

Release all brakes.

driving tip

On some air brake systems, one service reservoir may begin to fill first. When pressure reaches approximately 85 to 95 p.s.i. (586 to 655 kPa), the other reservoir will begin to fill, then pressure in both service reservoirs will build to full pressure.

Regardless of the type of system, pressure must build from 50 to 90 p.s.i. (345 to 620 kPa) within three minutes.

3. Air brake system test

Start lowering the air pressure by pumping brake pedal.

Perform the following steps:

1. Pump down to approximately 80 per cent of maximum pressure (for example, if maximum is 125 p.s.i., pump down to 100 p.s.i.). Pause and check that air pressure begins to build (to confirm governor cut-in pressure). In all cases, the governor must cause the compressor to cut in before pressure falls below 80 p.s.i. (552 kPa).
2. Pump down farther. Check that low-air warning device(s) activate at or above 60 p.s.i. (414 kPa).
3. Pump down to below 50 p.s.i. (345 kPa).
4. Rebuild air pressure. Check that air pressure builds from 50 to 90 p.s.i. (345 to 620 kPa) within three minutes at fast idle (1,000 to 1,200 r.p.m.).
5. Release spring parking brakes (if they had previously applied).

4. Circle check for lights

Turn on left turn signal, low-beam headlights, and clearance lights.

- Conduct circle check by walking counter-clockwise to face traffic. Be particularly cautious when you're walking with your back to traffic.

driving tip

Carry a rag with you to wipe all lenses as you make sure the lights are working.

<input type="checkbox"/> Lights	<p>As you inspect the vehicle, check all lights:</p> <ul style="list-style-type: none"> • ensure they work • lenses are clean and not cracked • lenses are correct colour
--	--

**Class 3
pre-trip inspection**

1. Check that left-turn signal, low-beam headlights, tail lights, licence plate lights, and clearance lights are working.

Turn off left-turn signal. Turn on high-beam headlights and right-turn signal.

2. Check that right-turn signal and high-beam headlights are working.
3. Check that brake lights are working.

Return to cab. Turn off lights. Turn off engine.

5. Mechanical circle check

Leave cab and begin circle check.

Left side of truck

driving tip

Check for air leakage with the engine off. This allows you to listen for leaks.

<input type="checkbox"/> Mirrors	• ensure they're securely attached
<input type="checkbox"/> Steps and hand rails	• ensure they're secure
<input type="checkbox"/> Fuel tanks	• ensure tanks, fuel caps and fuel lines are securely fastened
<input type="checkbox"/> Exhaust system	• ensure it's in good condition • no leaks • mufflers, pipes and shields securely fastened
<input type="checkbox"/> Battery compartments	• batteries securely fastened to battery compartment and compartments securely fastened • no corrosion on batteries • no battery leaks • battery cables secure
<input type="checkbox"/> Storage compartments	• ensure compartments are securely fastened • doors open and close properly • contents are secure
<input type="checkbox"/> Body	• check for body damage
<input type="checkbox"/> Frame	• check frame
<input type="checkbox"/> Load security devices	• load is secured • adequate load security devices are in place and are tight
<input type="checkbox"/> Suspension	• check rear suspension
<input type="checkbox"/> Tires/wheels/mud flaps	• check truck drive wheels
<input type="checkbox"/> Cab protector (if equipped)	• secure to frame • free of damage

fast fact

Typical emergency equipment on a commercial vehicle includes:

- flags or flares
- first aid kit
- fire extinguisher.

**Class 3
pre-trip inspection**

driving tip

Make sure the load you're carrying is secure.

Rear of truck

<input type="checkbox"/> Cargo doors/lift/tailgate	<ul style="list-style-type: none"> doors are securely mounted securely closed or latched lift is fully retracted lift has no leaks, or damaged or missing parts
<input type="checkbox"/> Cargo	<ul style="list-style-type: none"> load is secured adequate load security devices are in place and are tight
<input type="checkbox"/> Licence plate	<ul style="list-style-type: none"> check for licence plate

Underside of rear of truck

<input type="checkbox"/> Foundation brakes	<ul style="list-style-type: none"> check truck brakes
<input type="checkbox"/> Axle assembly	<ul style="list-style-type: none"> ensure there are no breaks, bends, cracks, holes, broken seals or leaks securely fastened to truck
<input type="checkbox"/> Drive line	<ul style="list-style-type: none"> check u-joints for free play check for leaks
<input type="checkbox"/> Frame	<ul style="list-style-type: none"> check frame for damage or loose or missing cross members no holes, bends, cracks or weld separations

Right side of truck

<input type="checkbox"/> Mirrors	<ul style="list-style-type: none"> ensure they are securely attached
<input type="checkbox"/> Steps and hand rails	<ul style="list-style-type: none"> ensure they're secure
<input type="checkbox"/> Fuel tanks	<ul style="list-style-type: none"> ensure tanks, fuel caps and fuel lines are securely fastened
<input type="checkbox"/> Exhaust system	<ul style="list-style-type: none"> ensure it's in good condition no leaks mufflers, pipes and shields securely fastened
<input type="checkbox"/> Battery compartments	<ul style="list-style-type: none"> batteries securely fastened to battery compartment and compartments securely fastened no corrosion on batteries no battery leaks battery cables secure
<input type="checkbox"/> Storage compartments	<ul style="list-style-type: none"> ensure compartments are securely fastened doors open and close properly contents are secure
<input type="checkbox"/> Body	<ul style="list-style-type: none"> check for body damage check for valid CVIP inspection decal
<input type="checkbox"/> Suspension	<ul style="list-style-type: none"> check rear suspension
<input type="checkbox"/> Tires/wheels/mud flaps	<ul style="list-style-type: none"> check drive wheels

**Class 3
pre-trip inspection**

driving tip

Make sure the spring brakes are released before making a heavy brake application to avoid compounding the brakes.

driving tip

Check brake adjustment when you are underneath the truck.

Return to cab.

Check that air pressure is at least 100 p.s.i. (690 kPa).

Check that parking brakes are released.

Make a full brake application (90 to 100 p.s.i., 620 to 690 kPa) and hold it for one minute:

- *Check to ensure that, after the initial pressure drop, air loss is not more than three p.s.i. (20.7 kPa) per minute.*
- *Check that there are no audible air leaks.*

Set parking brakes. Remove wheel blocks.

6. Brake response, tug and steering wheel slack tests

Perform these steps:

1. *Depress clutch. Shift transmission into neutral and start engine.*
2. *Ensure air pressure is up to operating range.*
3. *In low gear, gently tug against the parking brakes. The brakes should prevent the truck from moving.*
4. *Release all brakes.*
5. *Move the truck ahead slowly and apply the foot brake to check brake response.*
6. *Move the steering wheel to check for excessive slack or lash (play).*

Bus pre-trip inspection — Class 2 or Class 4 (unrestricted)

The next pages detail the suggested pre-trip inspection of a bus. **If the bus is equipped with air brakes, you should also refer to the Class 3 pre-trip procedures to check the air brake system.**

driving tip

It is often easier to spot leaks and body damage as you approach your vehicle than when you're right beside it.

On some types of buses, you may not be able to access all of the components listed.

You should be able to complete a Class 2 pre-trip inspection in less than 30 minutes, or a Class 4 pre-trip inspection in less than 20 minutes.

If the bus is equipped with air brakes, you must demonstrate your ability to set up a slack adjuster during your pre-trip inspection test. Refer to chapter 9, air brake adjustment for more information on this.

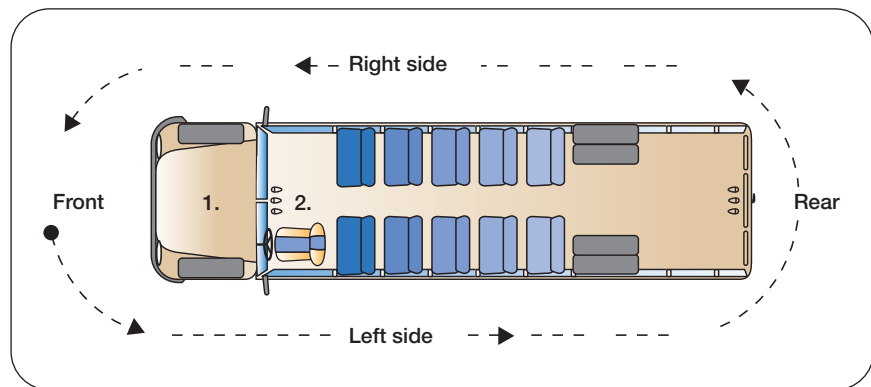

Before you begin:

- set the parking brakes
- shut off the engine
- block the wheels.

**Class 2 or Class 4
(unrestricted)
pre-trip inspection**

driving tip

As you are circling the vehicle conducting the pre-trip inspection, check each tire, wheel and mud flap. Also check suspension and frame, brake lines, brake chambers and slack adjusters. Measure air brake chamber pushrod travel.

Also remove the keys from the ignition to ensure that nobody tries to move the vehicle while you're checking underneath.

1. Engine compartment

As you approach, look under the vehicle for leaks.

Check the following:

<input type="checkbox"/> Licence plate	<ul style="list-style-type: none"> • check for licence plate and valid decal
<input type="checkbox"/> Fluids	<ul style="list-style-type: none"> • check fluid levels and condition (for example, colour, smell) including: engine oil, engine coolant, power steering fluid, brake fluid and windshield washer fluid
<input type="checkbox"/> Belts	<ul style="list-style-type: none"> • ensure any drive belts have good tension with no cracks, frayed cord or missing teeth
<input type="checkbox"/> Hoses	<ul style="list-style-type: none"> • ensure hose connections are secure with no kinks, leaks, cuts, abrasions or cracks
<input type="checkbox"/> Steering components	<ul style="list-style-type: none"> • check steering shaft, steering box, tie-rods, idler arm and connections • ensure they're secure • no bends or cracks
<input type="checkbox"/> Suspension	<p>As you inspect the vehicle, check the suspension at all wheels:</p> <ul style="list-style-type: none"> • ensure there are no cracked, missing or broken springs, torsion bars or walking beams • no loose, missing or broken U-bolts • if air suspension, no cracked, worn or inoperative airbags • mounts are secure
<input type="checkbox"/> Frame	<p>As you inspect the vehicle, check the frame:</p> <ul style="list-style-type: none"> • ensure there are no cracks, broken welds, holes or other damage to the frame including cross members and floor
<input type="checkbox"/> Tires/wheels/mud flaps	<p>As you inspect the vehicle, check all tires, wheels and mud flaps:</p> <ul style="list-style-type: none"> • check tires for inflation, signs of bulges, sidewall separation, cuts to cord, exposed or frayed belts • adequate tread depth • tire wear is even • duals are not touching and nothing is stuck between them • check wheels/rims for cracks, missing pieces or bends • ensure wheel lugs and nuts are secure, not missing, broken or loose (rust streaks may indicate loose wheel nuts) • with spoke wheels, also check that rims are securely fastened to the spokes (polished or shiny areas at flanges or clamps may indicate rim slippage from loose fasteners) • check wheel hub oil level by viewing through sight glass (if present) • check that mud flaps are secure • mud flaps don't rub tires

**Class 2 or Class 4
(unrestricted)
pre-trip inspection**

fast fact

A peace officer may place your vehicle out of service if drum brake linings are less than 1/4 inch (6.4 mm) thick or air disc brake pads are less than 1/8 inch (3.2 mm) thick.

Brakes

As you inspect the vehicle, check each brake:

- for leaks
- for missing or loose brake parts
- for brake lines with cracks or leaks

Close and secure engine compartment.

2. In cab

Seats, seatbelts

- ensure driver's seat and seatbelt are adjusted for you
- fastening devices are in working order and accessible

Mirrors

- ensure they're adjusted for you and are clean and free of cracks

Windows/windshield

- ensure they're clean and free of cracks and that they open and close

Documentation

- Ensure that all documentation is in the vehicle, valid and up-to-date including:
- vehicle licence, registration and insurance
 - logbook (if required)
 - CVIP inspection report (if required)
 - CVIP inspection decal on windshield (if required)
 - school bus permit (if required)

Turn ignition to the "on" position. Check the following:

Gauges/warning lights

- check oil pressure warning light or gauge

Start engine.

Instrument panel

- Ensure that all gauges and warning lights are working properly, and that they respond properly as the engine warms up:
- charge rate indicator or gauge — ensure voltmeter or ammeter works properly and the charge is good
 - oil pressure indicator or gauge — ensure that it indicates normal pressure soon after engine starts

**Class 2 or Class 4
(unrestricted)
pre-trip inspection**

<input type="checkbox"/> Instrument panel (cont.)	<ul style="list-style-type: none"> • coolant temperature indicator or gauge — check that indicator rises to normal operating temperature — light should go off after engine starts • fuel gauge — ensure it's working properly — indicates sufficient fuel • instrument lights — ensure they work
<input type="checkbox"/> Windshield wipers/washers	<ul style="list-style-type: none"> • ensure wipers and washers work
<input type="checkbox"/> Heater/defroster	<ul style="list-style-type: none"> • ensure heater and defroster controls work including fan, in heater and defroster positions
<input type="checkbox"/> Interior lights	<ul style="list-style-type: none"> • ensure they all work including dome lights, courtesy lights and step lights
<input type="checkbox"/> Horn	<ul style="list-style-type: none"> • ensure it works
<input type="checkbox"/> Four-way flashers	<ul style="list-style-type: none"> • check that both indicators on dashboard work (the exterior lights will be checked later as part of checking the turn signals)
<input type="checkbox"/> Emergency equipment	<ul style="list-style-type: none"> • warning devices — ensure they are in working condition • fire extinguisher — ensure the date on the label is valid • first aid kit — check that the contents are adequate
<input type="checkbox"/> Engine noises	<ul style="list-style-type: none"> • listen for unusual sounds
<input type="checkbox"/> School bus stop sign (if equipped)	<ul style="list-style-type: none"> • ensure that it works and is secure

Shut off engine. Leave key in the "on" or "accessory" position so that the lights may be turned on.

**Class 2 or Class 4
(unrestricted)
pre-trip inspection**

driving tip

Carry a rag with you to wipe all lenses as you make sure the lights are working.

driving tip

As you circle the vehicle conducting the pre-trip inspection, check each tire, wheel, mud flap and brake.

3. Circle check

Turn on left-turn signal, low-beam headlights, clearance lights and school bus lights.

- Conduct circle check by walking counter-clockwise to face traffic. Be particularly cautious when you're walking with your back to traffic.

Lights

As you inspect the vehicle, check all lights:

- ensure they work
- lenses are clean and not cracked
- lenses are correct colour

Left side of bus

Lights

- check low-beam headlights, left front turn signal, clearance lights and school bus lights

Mirrors

- ensure they're securely attached

Fuel cap

- ensure fuel cap is securely fastened

Exhaust system

- ensure it's in good condition
- no leaks
- mufflers, pipes and shields securely fastened

Battery compartments (if accessible)

- batteries securely fastened to battery compartment and compartments securely fastened
- no corrosion on batteries
- no battery leaks
- battery cables secure

Storage compartments

- ensure compartments are securely fastened
- doors open and close properly
- contents are secure

Body

- check for body damage

Frame

- check frame

Suspension

- check bus rear suspension

Drive line

- check u-joints for free play
- check for leaks

Tires/wheels/mud flaps

- check bus wheels

Brakes

- check brakes

**Class 2 or Class 4
(unrestricted)
pre-trip inspection**

Rear of bus

<input type="checkbox"/> Licence plate	<ul style="list-style-type: none"> • check for licence plate
<input type="checkbox"/> Lights	<ul style="list-style-type: none"> • check left rear turn signal, clearance lights, school bus lights, licence plate light and brake lights
<input type="checkbox"/> Axle assembly	<ul style="list-style-type: none"> • ensure there are no breaks, bends, cracks, holes, broken seals or leaks • securely fastened to bus
<input type="checkbox"/> Rear emergency exit door	<ul style="list-style-type: none"> • check that it opens and closes from the outside

Return to cab.

Turn off left-turn signal and school bus lights.

Turn on high-beam headlights and right-turn signal.

Exit cab and go to right side of bus.

Right side of bus

<input type="checkbox"/> Lights	<ul style="list-style-type: none"> • check right-turn signals
<input type="checkbox"/> Mirrors	<ul style="list-style-type: none"> • ensure they're securely attached
<input type="checkbox"/> Steps and hand rails	<ul style="list-style-type: none"> • ensure they're secure
<input type="checkbox"/> Fuel cap	<ul style="list-style-type: none"> • ensure fuel cap is securely fastened
<input type="checkbox"/> Exhaust system	<ul style="list-style-type: none"> • ensure it's in good condition • no leaks • mufflers, pipes and shields securely fastened
<input type="checkbox"/> Battery compartments (if accessible)	<ul style="list-style-type: none"> • batteries securely fastened to battery compartment and battery compartments securely fastened • no corrosion on batteries • no battery leaks • battery cables secure
<input type="checkbox"/> Storage compartments	<ul style="list-style-type: none"> • ensure compartments are securely fastened • doors open and close properly • contents are secure
<input type="checkbox"/> Body	<ul style="list-style-type: none"> • check for body damage • check for valid CVIP inspection decal
<input type="checkbox"/> Tires/wheels/mud flaps	<ul style="list-style-type: none"> • check drive wheels
<input type="checkbox"/> Lights	<ul style="list-style-type: none"> • check right-turn signals, clearance lights and high-beam headlights

**Class 2 or Class 4
(unrestricted)
pre-trip inspection**

Remove wheel blocks, making sure that parking brakes are set.

Return to cab.

4. Passenger compartment check

<input type="checkbox"/> Passenger seats	<ul style="list-style-type: none">• ensure all are securely fastened• no broken seat frames• check seatbelts (if equipped)• check for cleanliness
<input type="checkbox"/> Passenger doors and entrances	<ul style="list-style-type: none">• ensure doors open and close properly• ensure step lights are working properly• hand rails are secure
<input type="checkbox"/> Windows	<ul style="list-style-type: none">• ensure emergency windows are secure
<input type="checkbox"/> Emergency exits	<ul style="list-style-type: none">• ensure emergency exits are secure• open emergency exits (where feasible) to ensure that emergency alarm sounds

Start engine.

5. Brake response, tug and steering wheel slack tests

Perform these steps:

1. In low gear, gently tug against the parking brakes. The brakes should prevent the bus from moving.
2. Release brakes.
3. Move the bus ahead slowly and apply the foot brake to check brake response.
4. Move the steering wheel to check for excessive slack or lash (play).

Passenger vehicle pre-trip inspection — Class 4 (restricted)

The next pages detail the suggested pre-trip inspection of a restricted class 4 vehicle.

You should be able to complete this pre-trip inspection in less than 15 minutes.

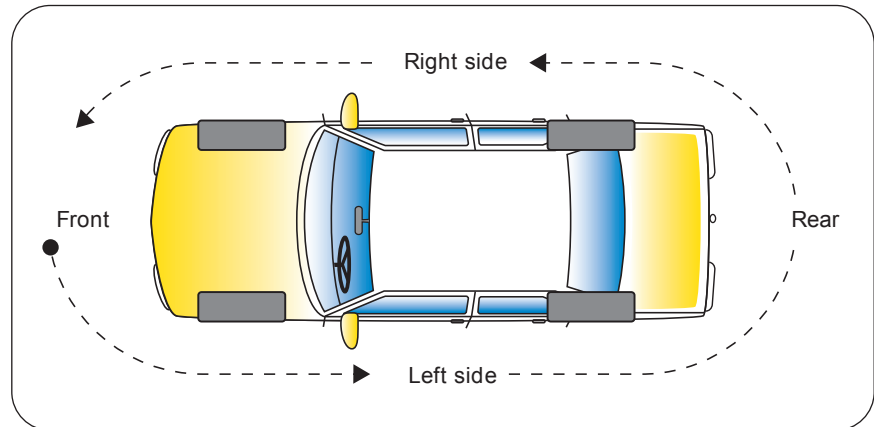

1. Under hood

As you approach, look under the vehicle for leaks. Check the following:

<input type="checkbox"/> Licence plate	<ul style="list-style-type: none"> • check for licence plate
<input type="checkbox"/> Fluids	<ul style="list-style-type: none"> • check fluid levels and condition (for example, colour, smell) including: engine oil, engine coolant, power steering fluid, brake fluid and windshield washer fluid
<input type="checkbox"/> Belts	<ul style="list-style-type: none"> • ensure any drive belts have good tension with no cracks, frayed cord or missing teeth
<input type="checkbox"/> Hoses	<ul style="list-style-type: none"> • ensure hose connections are secure with no kinks, leaks, cuts, abrasions or cracks
<input type="checkbox"/> Battery	<ul style="list-style-type: none"> • check for visible corrosion or leaks • terminal connections are secure • battery is securely mounted • battery fluid level (if accessible)
<input type="checkbox"/> Engine compartment	<ul style="list-style-type: none"> • check for fuel, oil or coolant leaks

Close and secure hood.

**Class 4 (restricted)
pre-trip inspection**

2. In passenger compartment

<input type="checkbox"/> Seats, seatbelts	<ul style="list-style-type: none"> • check driver's seat is adjusted for you and that seatbelt is in working order • check that all seatbelts are in good condition and work well • seats and passenger compartment is clean
<input type="checkbox"/> Mirrors	<ul style="list-style-type: none"> • ensure they're adjusted for you and that they're clean and free of cracks
<input type="checkbox"/> Windows/windshield	<ul style="list-style-type: none"> • ensure they're clean and free of cracks and that they open and close
<input type="checkbox"/> Documentation	<p>Ensure that all documentation is in the vehicle and is valid and up-to-date including:</p> <ul style="list-style-type: none"> • vehicle licence, registration and insurance • logbook (if required) • CVIP inspection report (if required) • CVIP inspection decal on windshield (if required)

Start engine, check the following:

<input type="checkbox"/> Instrument panel	<p>Ensure that all gauges and warning lights are working properly, and that they respond properly as the engine is started and warms up:</p> <ul style="list-style-type: none"> • charge rate indicator or gauge — ensure voltmeter or ammeter works properly and the charge is good • oil pressure indicator or gauge — ensure that it indicates normal pressure soon after engine starts • coolant temperature indicator or gauge — check that indicator rises to normal operating temperature — light should go off after engine starts • fuel gauge — indicates sufficient fuel • instrument lights — ensure they work
<input type="checkbox"/> Windshield wipers/washers	<ul style="list-style-type: none"> • ensure wipers and washers work
<input type="checkbox"/> Heater/defroster	<ul style="list-style-type: none"> • ensure heater and defroster controls work including fan, in heater and defroster positions

**Class 4 (restricted)
pre-trip inspection**

<input type="checkbox"/> Interior lights	• ensure they work
<input type="checkbox"/> Four-way flashers	• check that both indicators on dashboard work (the exterior lights will be checked later as part of checking the turn signals)
<input type="checkbox"/> Horn	• ensure it works
<input type="checkbox"/> Engine noises	• listen for unusual sounds

3. Circle check

Turn on left-turn signal and low-beam headlights.

Walk to the front of vehicle to begin circle check.

- Conduct circle check by walking counter-clockwise to face traffic. Be particularly cautious when you're walking with your back to traffic.

<input type="checkbox"/> Lights	As you inspect the vehicle, check all lights: • ensure they work • lenses are clean and not cracked • lenses are correct colour
---------------------------------	--

- Check that left-turn signal, low-beam headlights, tail lights and licence plate lights are working.

Return to driver's seat.

Turn on right-turn signal and high-beam headlights.

<input type="checkbox"/> Lights	• check right-turn signals, high-beam headlights, licence plate light and brake lights
<input type="checkbox"/> Mirrors	• ensure they are securely attached
<input type="checkbox"/> Doors	• ensure they open and close securely
<input type="checkbox"/> Exhaust system	• ensure it's in good condition • no leaks • muffler is securely fastened
<input type="checkbox"/> Fuel cap	• ensure it's present and secure
<input type="checkbox"/> Body	• check for body damage

**Class 4 (restricted)
pre-trip inspection**

driving tip

As you circle the vehicle conducting the pre-trip inspection, check each tire and wheel.

<input type="checkbox"/> Tires/wheels	<ul style="list-style-type: none">• check tires for inflation, signs of bulges, sidewall separation, cuts to cord, exposed or frayed belts• adequate tread depth• check wheels for damage• ensure wheel lugs are secure, not missing, broken or loose (if visible)
<input type="checkbox"/> Licence plate	<ul style="list-style-type: none">• check for licence plate and decal
<input type="checkbox"/> Trunk	<ul style="list-style-type: none">• ensure trunk lid opens and closes securely• check spare tire and jack• ensure propane tank, if present, is secure and not leaking

Return to driver's seat. Turn off headlights and right-turn signal.

4. Brake response tests

Perform these steps:

1. Depress brake pedal.
2. Shift transmission into low gear.
3. In low gear, gently tug against the parking brake. The brake should hold the vehicle.
4. Release the parking brake.
5. Move the vehicle ahead and apply the foot brake to check brake response.

Note: Whenever possible, have an assistant check the brake lights for you.

Pre-hill inspections

It's important to understand when and how to do pre-hill inspections. B.C. has many mountainous roads. For your safety and the safety of others on the road, you must know how to perform these inspections properly, and do them frequently.

In some areas of the province, signs are posted in advance of steep or long downgrades.

You must stop the vehicle in the pullout area and inspect the vehicle's braking system before proceeding. Check load security at the same time.

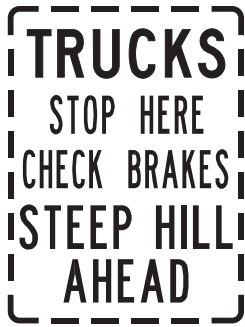

fast fact

You may be fined for failing to stop to conduct a brake pre-hill inspection.

driving tip

While drivers of heavy non-commercial vehicles such as motorhomes and truck-RV trailer combinations are not required by law to stop, they may use these pullout areas to check their brakes, too.

Check that:

- the compressor maintains full reservoir pressure
- there are no audible air leaks
- glad hands and air lines are secure
- brake drums and hubs are not overheated
- pushrod travel is within limits.

Note: You must check pushrod travel even if your vehicle is equipped with automatic slack adjusters.

If your vehicle is equipped with hydraulic brakes, check before you start down the hill that:

- there's adequate pedal reserve
- brake drums aren't over-heated
- there are no hydraulic fluid leaks

In-service brake checks

You need to be aware of the condition of the vehicle's braking system at all times. You can do this by:

1. Checking air pressure gauges frequently.
2. Checking the dashboard to see if the low-air warning indicator is on.
3. Feeling the braking response when you make a brake application.

En route inspections

Your pre-trip inspection should ensure your vehicle is safe before you start your day's trip. As you drive, the condition of your vehicle may change. It's important that you inspect your vehicle at regular intervals so you can identify any problems as soon as possible.

As well, the NSC requires you to re-inspect the cargo securement system within 80 km from the point where the cargo was loaded, and on a regular basis during the trip at the earliest of:

- a change in your duty status
- three hours of driving, or
- 240 km of driving since the last inspection.

You must record cargo securement on your daily log. You don't need to inspect cargo if it's sealed and you've been ordered not to inspect it, or if the cargo is inaccessible.

Stop your vehicle in a rest area or pull over to a safe area on the side of the highway. Then, take a careful walk around your vehicle. Walk counter-clockwise so that you're facing oncoming traffic.

Check the following:

Post-trip inspections

At the end of the final trip of the day you must inspect the commercial vehicle you've been driving and complete a trip inspection report. This report must note any defects you find during your inspection. Your post-trip inspection report may be added to the pre-trip inspection report you completed for the same vehicle earlier that day.

Lights and reflectors

Examine your lights and reflectors every time you inspect your vehicle to ensure they're in good condition. Check for proper colour, operation, mounting and visibility. Refer to the *Motor Vehicle Act Regulations* for the specific light and reflector requirements for your vehicle.

warning!

Don't continue driving a vehicle if there's smoke coming from an oil-filled hub, or where the hub is too hot to touch.

<input type="checkbox"/> Tires and wheels	<ul style="list-style-type: none"> • check tires for inflation • excessive heat build-up • signs of damage such as bulges, sidewall separation, cuts to cord, exposed or frayed belts • tire wear is even • duals aren't touching and nothing is stuck between them • check that wheels, wheel nuts and clamps are secure, not broken or loose or missing • signs of damage such as cracks or dents • rim slippage on spoke wheels
<input type="checkbox"/> Brakes and hubs	<ul style="list-style-type: none"> • check that brake drums and hubs aren't overheated • air lines are secure
<input type="checkbox"/> Trailer coupling	<ul style="list-style-type: none"> • ensure fifth wheel or other coupling device is securely fastened
<input type="checkbox"/> Cargo and dangerous goods signs	<ul style="list-style-type: none"> • check that blocks, bracing, ties or chains are secure • header board (if present) is secure • sideboards or stakes are secure • canvas or tarp (if used) is secure • cargo doors are securely latched • dangerous goods signs (if required) are securely fastened and in the appropriate places
<input type="checkbox"/> Suspension and driveline	<ul style="list-style-type: none"> • check that axles aren't leaking • check that springs, shock absorbers, struts, etc., are in good condition

driving tip

Commercial trailers with an overall width of 2.05 m or more are required to have reflective markings to the rear and sides.

Reflective markings, in addition to the required lights and reflectors, help improve the visibility of large commercial vehicles.

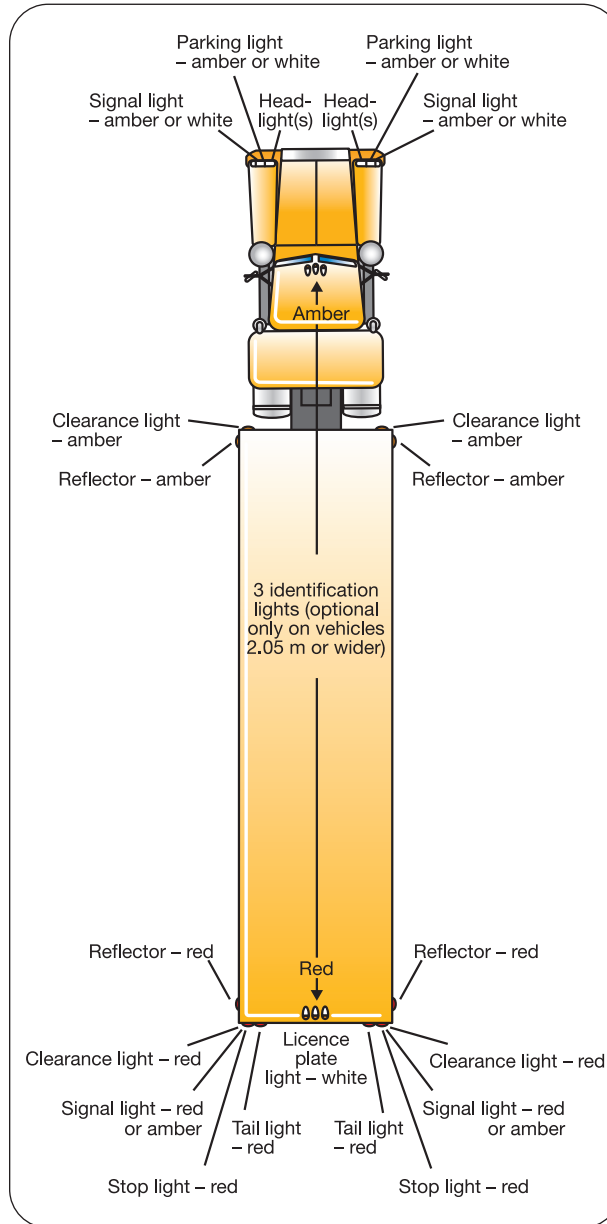

This illustration shows the general position and colour of lights and reflectors you will find on most vehicles.

Review questions

1. Why are drivers required to complete a trip inspection report?
2. Under what circumstance are both drivers of a vehicle required to sign a trip inspection report?
3. When and why are you required to complete a pre-hill inspection?
4. How often are you required to inspect your vehicle during a trip?
5. Regardless of maintenance policies, who's responsible for ensuring that the brakes of a vehicle are in working order before the vehicle is placed into operation?
6. What's the advantage of doing a regular pre-trip vehicle inspection?
7. Is it always necessary that drivers of large trucks stop and check their brakes if a sign requiring drivers to stop and check their brakes is posted?
8. How often should you inspect your vehicle?
9. How do you check for air leakage during an air brake pre-trip inspection?
10. How do you check that the compressor and governor are operating correctly?
11. How do you check the brake chamber pushrod travel?
12. What parts of the air brake system should you check at a brake check stop?
13. What components should be checked during an en route inspection?

This chapter is a handy reference section that gives examples of the most common signs, signals and road markings that keep traffic organized and flowing smoothly.

- Signs

- regulatory signs
- school, playground and crosswalk signs
- lane use signs
- turn control signs
- parking signs
- reserved lane signs
- warning signs
- object markers
- construction signs
- information and destination signs
- railway signs

- Signals

- lane control signals
- traffic lights

- Road markings

- yellow lines
- white lines
- reserved lane markings
- other markings

Signs

There are three ways to read signs: by their shape, colour and the messages printed on them. Understanding these three ways of classifying signs will help you figure out the meaning of signs that are new to you.

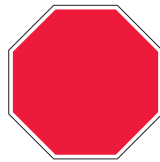

Stop



Yield the right-of-way

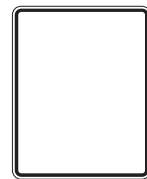

Shows driving regulations

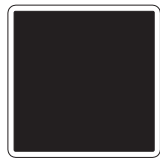

Explains lane use

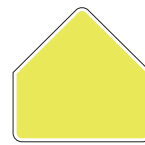

School zone signs are fluorescent yellow-green

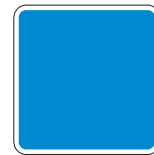

Tells about motorist services



Shows a permitted action



Shows an action that is not permitted



Warns of hazards ahead



Warns of construction zones



Railway crossing



Shows distance and direction

Regulatory signs

These signs tell you about driving laws and regulations. It is an offence under the B.C. *Motor Vehicle Act* to disregard them. Drivers who do not follow the instructions on these signs may receive penalties.



Stop completely — continue only when safe



Give the right-of-way to other vehicles and crossing pedestrians



The maximum legal speed when the road is bare and dry and visibility is good



Indicates a lower speed limit ahead



Do not enter



Do not go this way — usually mounted on exit ramps



One way — gives direction of traffic on cross street



Winter tires or chains must be used when sign is displayed



Stay off this road during major disasters — road may be used only by emergency vehicles



Move into right lane if driving slower than regular traffic



Keep right unless passing



Passing lane ahead



Do not pass



Two-way traffic — keep right unless passing



Keep right of the divider



No stopping between here and the next no-stopping sign



No stopping during posted times between here and the next sign



No bicycle riding beyond this point



No right turn on red light



Slow vehicles to use pullouts for the next stated distance



Slow vehicle pullout stated meters ahead



Slow vehicle pullout



Slow traffic delaying 5 vehicles must use pullout



Slow traffic delaying vehicles use pullouts

School, playground and crosswalk signs

These signs tell you the rules to follow in areas where you need to be extra cautious.

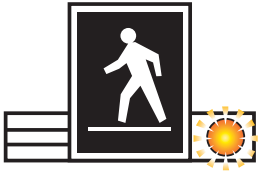

Pedestrian activated crosswalk — prepare to stop if the light is flashing



Pedestrian crosswalk — yield to people crossing



School crosswalk — yield to pedestrians — if there is a crossing guard, follow directions



School zone — reduce speed when children are present



Playground nearby — be prepared to slow down



Playground zone — 30 km/h limit is in effect every day from dawn to dusk



School zone — 50 km/h limit is in effect from 8 a.m. to 5 p.m. on school days when children are on the roadway or shoulder



School zone — if the tab underneath only indicates the speed limit, that limit is in effect from 8 a.m. to 5 p.m. on school days



School zone — the tab underneath indicates the speed limit and the hours that it is in effect (in this case, the 30 km/h limit is in effect from 8 a.m. to 5 p.m. on school days)

Lane use signs

Signs showing which lanes may be used to turn or go straight are mounted above the lane or at the side of the lane before the intersection. If you are in a designated lane, you must follow the direction indicated by the arrows. You may not move into or out of a designated lane while you are in an intersection.



Turn left only



Continue straight only



Go through or turn left



Go through or turn right



Vehicles from both directions must turn left, no through traffic allowed



Vehicles in both these lanes must turn left

Turn control signs

Turn control signs are mounted directly above the intersection. You must follow the direction of the arrow.



Left turn only



Go straight only
— no turns



Turn right or left
only



No right turns during
posted times

Parking signs

Parking signs let you know where and when you are allowed to park. You may receive fines or your vehicle may be towed (or both) if you park illegally.



Time-limited parking
during posted times



Do not park
here



Parking is not
allowed during
posted times



Parking only for vehicles
displaying the disabled
parking sign and carrying
a person with disabilities

Reserved lane signs

A white diamond painted on the road surface marks reserved lanes. Reserved lane signs are also placed over or beside lanes that are reserved for certain vehicles such as buses or high occupancy vehicles (HOVs). Other HOV signs may give additional information on who may use the HOV lane.



Only buses in this lane



Only buses and HOVs
in this lane — may show
how many people must
be in the HOV



Curb lane of cross street
ahead is a reserved lane

Warning signs

Most warning signs are yellow and diamond-shaped. They warn of possible hazards ahead.



Winding road ahead



Hidden side road ahead



30
km/h
Sharp curve ahead — slow to suggested speed



Curve ahead — slow down



Merging traffic ahead



Road merges with another road — added lane to the right ahead



Right lane ends ahead



Divided highway ends ahead — keep right



Two-way traffic ahead



Road narrows ahead



Narrow structure ahead — often a bridge



Bump or rough road ahead



Road may be slippery ahead



Steep hill ahead — slow down



Stop sign ahead



Roundabout ahead



Signal lights ahead



Signal lights ahead — prepare to stop when lights are flashing



Pedestrian crosswalk ahead



School crosswalk ahead
— this sign is fluorescent yellow-green



School bus stop ahead



Cyclists may be on roadway



Fire truck entrance ahead



Truck crossing ahead



Recommended exit speed — drive slower in poor conditions



Pavement ends ahead



Hazard or danger ahead
— turn right or left



Watch for deer ahead



Opening bridge ahead



Watch for rocks on the road ahead



Tunnel ahead



Remove sunglasses



Snow shed ahead



Use headlights ahead

Object markers

Pay special attention to object markers — they are mounted on obstructions.



Obstruction — keep right or left



Obstruction — keep right



Obstruction — keep left

Construction signs

These signs warn of construction and maintenance work. You must pay attention to the warnings and obey the instructions on these signs. Obey traffic-control persons, travel within the posted speed, stay well back from all equipment and pass only when it is safe.



Detour ahead



Soft shoulder ahead — stay off



Construction ahead



Traffic-control person ahead



Crew working — obey posted speed limit



Survey crew — obey posted speed limit



End of construction zone speed limit



Fine notice for speeding in a work zone



Blasting ahead — follow instructions on sign



Follow the lighted arrow

Information and destination signs

These signs give information about destinations, route numbers and facilities. Here are a few samples.



Destination sign — distances are in kilometres

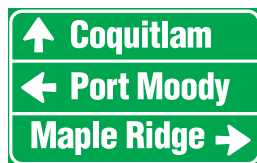

Directional sign



Trans-Canada Highway route marker



Primary highway marker sign



Hospital nearby



Gas available ahead



Accommodation ahead



Travel information ahead

Railway signs

Public railway and highway crossings are indicated with signs or pavement markings and may also have mechanical or electrical warning devices for your protection. Watch for them and remember you must always yield to trains.



Railway crossing ahead — be prepared to stop



Railway crossing on side road ahead — be prepared to stop

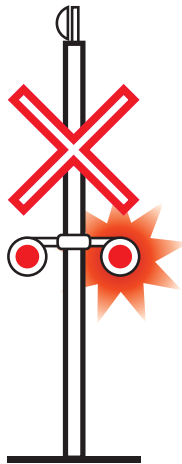

Railway crossing — stop, then proceed when it is safe

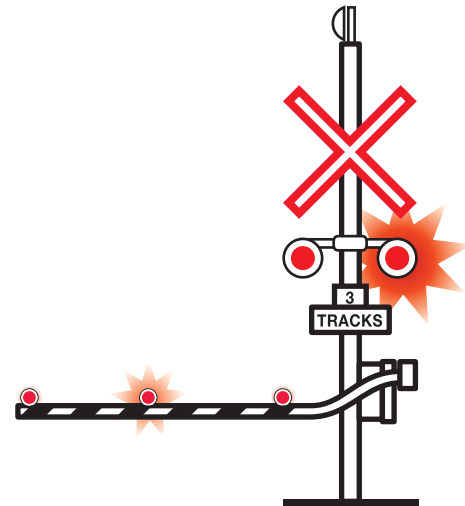

Railway crossing — stay stopped until the gate is fully raised

Signals

Lighted signals are a way of controlling traffic flow.

Lane control signals

Lane control signals are placed over lanes to indicate which ones are open for driving.



Do not drive in this lane



Move out of this lane and into a lane with a green arrow. If the lane control signals over all of the lanes are flashing yellow, slow down and proceed with caution



Drive in this lane

Traffic lights

Traffic lights are used to help organize the flow of traffic. Generally, a red light means “stop,” a yellow light means “caution” and a green light means “go.” These signals can have slightly different meanings if they are flashing or if they are shaped as arrows rather than circles. In some places green arrows may flash; in others they may not.

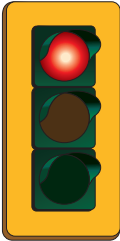

Steady red — stop — after coming to a full stop, you may turn right or turn left onto a one-way street unless a sign forbids it

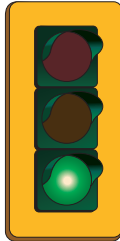

Steady green — continue if the intersection is clear

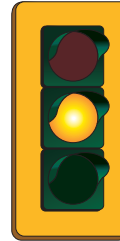

Steady yellow — slow down and stop before the intersection unless you can't safely stop in time

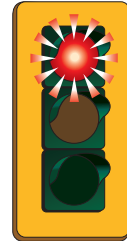

Flashing red — stop, then continue only when it is safe

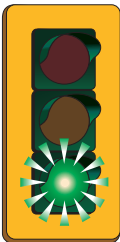

Flashing green — pedestrian-controlled light — go only if the intersection is clear



Flashing yellow — slow down and proceed with caution

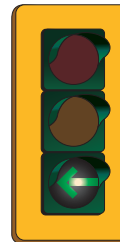

Green arrow — turn in the direction of the arrow

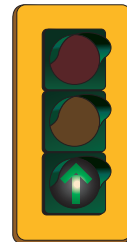

Green arrow — no turn permitted; go straight through only



Flashing green arrow with a steady green light — may turn in the direction of the arrow or proceed

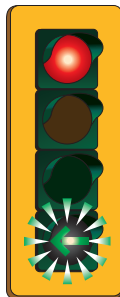

Flashing green arrow with a steady red light — left turn allowed; through traffic must stop for red light

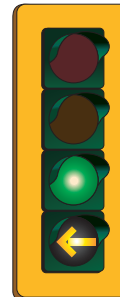

Yellow arrow — advance left turn signal is about to change, slow down and stop before the intersection unless you can't safely stop in time

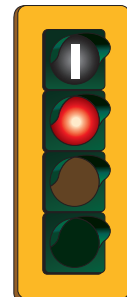

Transit priority signal — steady white rectangular light — only buses may go on this signal

Road markings

Road markings give you warnings or direction. They are painted on the roadway, curbs or other surfaces. It is illegal to drive over freshly painted, wet pavement markings.

Yellow lines

Yellow lines divide traffic moving in opposite directions. If there is a yellow line to your left, there will be traffic coming towards you on the other side of that yellow line.



Broken line — passing is allowed when safe



Broken line and solid line — you may pass only when it is safe and the broken line is on your side



Double solid line — no passing allowed



Single yellow line — passing is allowed with extra caution

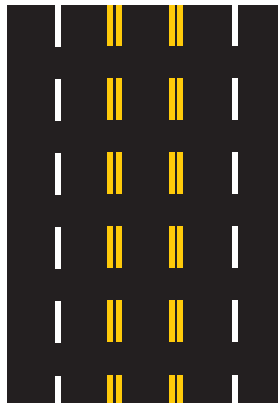

Double broken yellow line — lane is reversible — lane control signal will show whether you may use this lane

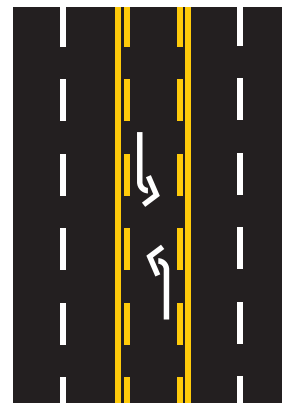

Two-way left-turn lane — drivers travelling in opposite directions share this lane for left turns — markings may be reversed (solid lines inside the broken lines)

White lines

White lines are used to separate lanes of traffic moving in the same direction. White lines also mark crosswalks, stopping positions and the right shoulders of highways.

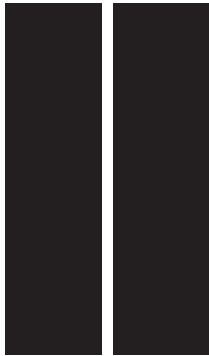

Solid line — do not change lanes



Broken line — lane changing is allowed when safe



Stop line — stop before this line

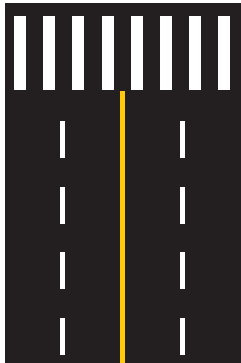

Pedestrian crosswalk — stop for pedestrians in the crosswalk



Pedestrian crosswalk — stop for pedestrians in the crosswalk

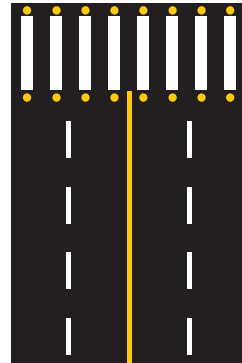

Pedestrian-activated crosswalk with illuminating lights in pavement — stop for pedestrians in the crosswalk

Reserved lane markings

These markings set off lanes for HOVs, buses and bicycles. HOV lanes are marked with thick solid or broken lines and white diamond symbols.

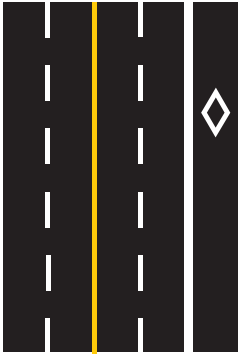

Reserved lane — additional signs or markings state which vehicles are allowed

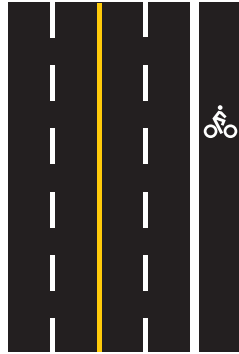

Bicycle lane — for cyclists only — cyclists must travel in the same direction as the traffic beside them — the lane is marked with an outline of a bicycle and sometimes with a diamond

Other markings

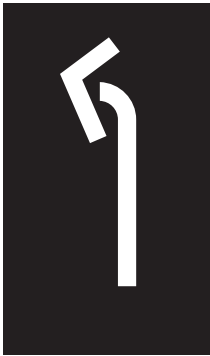

Vehicles in this lane must turn left

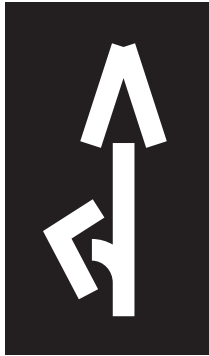

Vehicles in this lane must go straight or turn left

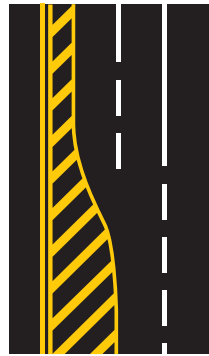

Painted island — keep to the right and do not drive on or over

Review questions

1. What colour and shape is:
 - a warning sign
 - a stop sign
 - a yield sign
 - a school sign
 - a lane use sign
 - a construction zone sign
 - a railway crossing sign?
2. What should you do when approaching:
 - a flashing red light
 - a steady red light
 - a flashing yellow light
 - a steady yellow light
 - a flashing green light?
3. What can you do when approaching a flashing green arrow with a steady red light?
4. Name five regulatory signs and five warning signs.
5. What's the difference between a lane-use sign and a turn-control sign?
6. What must you do when approaching a railway crossing that displays flashing red lights?
7. Over which of the following roadmarkings are you permitted to pass:
 - a broken yellow line
 - a single yellow line
 - a broken line and solid line where the broken line is on your side
 - a broken line and solid line where the broken line is not on your side
 - a double yellow line?
8. What colour are the lines that separate lanes of traffic moving in the same direction?
9. What colour are the lines that divide traffic moving in opposite directions?
10. What must you do when approaching a stop sign? What must you do when approaching a yield sign?
11. When a speed limit tab is shown under a school zone sign, when's that speed limit in effect? What if the tab is under a playground zone?

What you'll learn

After studying this chapter you'll be able to:

- define an industrial road
- describe the requirements for inspecting your vehicle for industrial road use
- list and describe the special brake requirements for industrial roads
- list and describe the special safety considerations for driving on an industrial road
- explain the right-of-way rules on industrial roads
- describe how to obtain an industrial air brake endorsement.

Industrial logging truck combinations are usually much bigger than logging trucks seen on public roads.

**fast fact**

Very few drivers require an industrial air brake endorsement. You need an industrial endorsement only if you'll be operating unlicensed vehicles that are equipped with air brakes and are used to transport natural resources on industrial roads.

You don't need an industrial air brake endorsement to operate skidders, loaders, graders or yarders on industrial roads.

Contact a driver licensing office for details.

An industrial road is any road that exists for the transportation of natural resources, machinery, materials or personnel. Industrial roads include all company bridges, wharves and log dumps. They don't include:

- public highways, streets or lanes
- forest service roads as defined in the *Forest Act*
- development roads as defined in the *Petroleum and Natural Gas Act*
- privately owned roads used by farmers or residents for their own purposes
- roads used exclusively for the construction and maintenance of electric power lines, telephone lines or pipelines
- roads and yards within manufacturing plants, industrial sites, storage yards, airports or construction sites
- tote roads, cat roads and access roads.

fast fact

An industrial air brake endorsement is sometimes called an off-highway endorsement.

Industrial air brake endorsement

An industrial air brake endorsement on your driver's licence permits you to operate unlicensed vehicles that are equipped with air brakes and used to transport natural resources on industrial roads. These vehicles include dump trucks and logging trucks. Some logging trucks travelling on industrial roads carry loads that are two to three times the size of those carried by logging trucks on public roads. The loads transported on industrial roads may also be longer and wider than the loads permitted on public roads.

You don't need an industrial air brake endorsement to operate every type of vehicle that is equipped with air brakes on industrial roads. The exceptions include skidders, loaders, graders and yarders.

There are two types of industrial air brake endorsements:

- **Code 18** permits you to drive on industrial roads while operating an unlicensed single-unit vehicle equipped with air brakes.
- **Code 19** permits you to drive on industrial roads while operating an unlicensed single-unit vehicle or a combination vehicle equipped with air brakes.

The relevant endorsement will be printed in the "restrictions" section of your driver's licence.

How to apply for an industrial air brake endorsement

Apply for an industrial air brake endorsement at a driver licensing office. You'll be required to:

- Submit a medical report form completed by a B.C.-licensed physician who knows your medical history. The form is available at driver licensing offices.
- Submit a letter of proficiency from a current or previous employer.

Note: The letter of proficiency must outline your industrial air brake experience. The letter must also include a list of the types of vehicles you have operated and the total amount of time you've operated them. The minimum acceptable time is three months.

- Pass an air brake knowledge test.

You'll receive a temporary licence with an industrial air brake endorsement after you successfully complete the test and pay the fee for your new driver's licence. Your new photo licence will be mailed to you.

Driver's duty to inspect vehicles

You must determine that your vehicle is in safe operating condition before you drive it. This is part of your job and your responsibility as a professional driver. If you operate your vehicle when it's not safe, you're putting yourself and others at risk.

Taking the time for pre-trip inspections can prevent costly en route delays and reduce the chances of a crash caused by a mechanical failure.

fast fact

You must hold an appropriate driver's licence to operate a licensed vehicle or any vehicle carrying anything other than natural resources. You must have an on-highway air brake endorsement to drive any of these vehicles if they are equipped with air brakes.

fast fact

When brakes overheat, the drums expand away from the brake shoes. This reduces your vehicle's braking efficiency.

fast fact

The *Industrial Roads Act* sets out which sections of the *Motor Vehicle Act* apply to industrial roads.

Perform a pre-trip inspection of your vehicle daily before you place the vehicle in service. Keep an up-to-date maintenance logbook to ensure vehicles are being properly maintained.

Reporting defects

You must always be certain that the vehicle you're about to use is in safe operating condition. If you find any defects, notify the proper company authority.

Don't operate a vehicle that is unsafe.

Brakes

Good brakes are important no matter what type of road you drive on. Industrial roads don't usually have run away lanes so it's extra important to ensure your brakes are in good condition.

Brake test

Test the brakes on your vehicle before you transport any load. Make a rolling brake test before you take a loaded vehicle down any steep hills.

If your brakes aren't operating safely at any time, stop the vehicle in a safe place. Park and secure your vehicle or combination of vehicles in a safe manner. Don't drive the vehicle until the brakes are repaired.

Water cooled brakes

Many vehicles that operate on industrial roads are extremely heavy. Stopping these heavy vehicles puts a lot of pressure on their brakes, which can cause brakes to overheat. Some of these vehicles use water to help prevent brake drum overheating.

Turn on the water supply so that water is directed at the brake drums just after you begin to apply your brakes. At this point the brake drums will be only slightly warm. Turn off the water supply when you are about to bring your vehicle to a complete stop. This will help ensure your brake drums contract evenly. Brake drums can crack if they are cooled on only one side. Most water tanks are pressurized with compressed air at low pressure — this pressure should be at least 15 p.s.i. (103 kPa).

Parking

When you leave a parked vehicle unattended, you must set the mechanical brake. You must also secure the vehicle so that it doesn't need air or fluid pressure to hold it in place.

Driving on industrial roads

Industrial roads are often rougher and present different types of conditions than public roads. In general, drivers are expected to follow the rules of the road set out in the *Motor Vehicle Act*.

definition

A **turnout** is a place to pull off the road so that other vehicles may pass.

Speed

Obey all posted speed signs. Always match your speed to the condition of the roadway. Your prime responsibility is to ensure the safety of yourself, other road users, your vehicle and your load.

Right-of-way

Use a turnout on a narrow road to give right-of-way to a loaded truck.

Similarly, give right-of-way to a loaded truck when it's coming down a steep hill on an industrial road.

Warning signals

You must signal your intention to turn, stop or change course on an industrial road in the same way that you would on any public road.

Before backing any truck or tractor and trailer into a loading area:

- sound your horn to provide a warning
- have the head loader or other responsible person direct you into the area after checking that no one is in your path.

Railway crossings

You must stop before you cross any railway line that intersects with a public or private road when you're driving crew cars with passengers in them. You must be certain that there are no trains coming from either direction before you cross. Don't shift gears while crossing railway tracks.

Safety tips

You should drive on the right side of industrial roads as a rule.

Use caution when entering any public road. You must follow all the rules of the road when you travel on any public highway.

Highway crossing permits

You may operate unlicensed vehicles on industrial roads. If you plan to take an unlicensed vehicle across a public highway on a regular basis, you must have a crossing permit. To obtain a Highway Crossing permit, call the Commercial Vehicle Safety and Enforcement Branch's toll-free permit line 1-800-559-9688 or contact a weigh scale.

Review questions

1. What's an industrial road?
2. What's an off-highway endorsement?
3. If you perform a brake test and find that the brakes aren't operating safely, what should you do?
4. Why do you turn on a water spray as you begin to apply your brakes and then turn the water spray off just before bringing the vehicle to a complete stop?
5. Who has the right-of-way on a steep hill on an industrial road?
6. What determines which truck should turn out on a narrow road?
7. What two things should you do before backing into a loading area on an industrial road?
8. Under what condition can you cross a railway line intersecting between a private and public road without stopping?
9. What's a highway crossing permit and when do you require one?

Dangerous goods

Dangerous goods training is available through some colleges, driving schools and consultants who specialize in this field. Contact the ones nearest you for information about courses.

In case of an emergency

You're required to notify these people and agencies any time you're in control of dangerous goods and there is a spill or other type of dangerous occurrence:

- **Provincial Emergency Program (PEP) Coordination Centre:**
1-800-663-3456, or

- local police.

After calling one or both of the above immediately, you must also notify:

- your employer
- the owner of your vehicle
- the consignor or owner of the goods.

For spills of Class 6.2 Infectious Substances, or for accidental release from a cylinder that has suffered catastrophic failure, call CANUTEC at 613-996-6666 (call collect).

It's the driver's responsibility to immediately take all reasonable emergency measures to repair, remedy or reduce any danger to life, health, property or the environment whenever there's a dangerous goods incident.

The PEP Coordination Centre (first on the "who-to-contact" list), is staffed 24 hours a day, 365 days a year. Call this number to report any possible spill of dangerous goods. This office will advise the British Columbia Ministry of Environment and Environment Canada.

Federal contacts

Canadian Transport Emergency Centre (CANUTEC)

CANUTEC provides technical advice on dangerous goods. Staff will answer questions about the specific properties of different materials and the best methods for storing and cleaning up specific goods. CANUTEC will also refer you to companies who provide appropriate clean-up services.

- 24-hour emergency information: 613-996-6666 (call collect)
- Emergency cellphone number: *666
- Non-emergency number: 613-992-4624 (call collect)

Transport Canada

Transport Dangerous Goods is a division of Transport Canada that promotes public safety and monitors compliance with the *Transportation of Dangerous Goods Act and Regulations*. Inspectors make spot checks to check that dangerous goods cargoes are properly labeled and contained.

- Information: 604-666-2955 (call collect)

For smart ways to be fuel-efficient, contact Natural Resources Canada's Office of Energy Efficiency.

- Information: 1-800-387-2000
- Website: nrcan.gc.ca

Environment Canada

Environment Canada is a federal agency. Staff at this agency deal primarily with spills and other events that affect oceans and waterways. Call the Provincial Emergency Program (PEP) 1-800-663-3456 if you have a dangerous goods spill. Staff at PEP will contact Environment Canada.

- Information: 604-664-9100 (call collect)

Commercial vehicle information

Commercial vehicle safety and enforcement

This provincial department provides information on commercial vehicle permits, vehicle inspections and standards, vehicle configurations, weigh scale locations and other compliance-related concerns.

- Call during regular office hours: 250-952-0577

Report commercial vehicle safety violations

Call the Provincial Commercial Vehicle Safety and Enforcement Department if you have concerns about unsafe buses, taxis or trucks. Before calling, please make notes on the vehicle, the time, the location and the safety issue you are concerned about.

- Accessible 24 hours a day: 1-888-775-8785 (province-wide)

Commercial vehicle permit line

Call the Provincial Commercial Vehicle Permit Line when you need information about permits and your local scale is closed. This number is toll-free for callers anywhere in Canada or the United States. Permits available through this line include: non-resident commercial vehicle permits, term oversize and overweight permits, single trip oversize and overweight permits, engine fuel tax permits and highway crossing permits.

- Accessible 24 hours a day: 1-800-559-9688

Dangerous goods inspectors

Contact a provincial dangerous goods inspector to learn more about transporting dangerous goods in B.C.

Dangerous goods head office

- Victoria, B.C.: 250-953-4032

Metro Vancouver/Fraser Valley

- 604-575-3432

Interior

- Cranbrook, B.C.: 250-426-1311

Northern Region

- Prince George, B.C.: 250-561-5636

Passenger transportation branch

The Passenger Transportation Branch (formerly Motor Carrier Branch) licenses commercial passenger transportation services in B.C., such as taxis, buses and limousines.

- For general information call 1-604-453-4250

Booking road tests and licensing information

Book your road test online at icbc.com/roadtest*

For all driver licensing inquiries including commercial road test bookings call:

- In Metro Vancouver: 604-982-2250
- Greater Victoria: 250-978-8300
- Toll-free throughout B.C.: 1-800-950-1498

* Third party booking sites who charge a fee or collect your information are not affiliated with ICBC. There is no charge for booking a road test.

Medical qualifications

RoadSafetyBC identifies and assesses drivers to determine if they are physically, cognitively and medically fit to drive.

- Information: 250-387-7747
- Enquiry B.C. provides toll-free connection: 1-800-663-7867

More information

To report a claim, call Dial-a-Claim 24/7 at:

- 604-520-8222 (Lower Mainland)
- 1-800-910-4222 (elsewhere in B.C., Canada or U.S.)

If you've had a crash with no injuries, or want to report vandalism or theft from your vehicle, you can do that quickly and easily anytime online at icbc.com

For general inquiries, call ICBC Customer Services at:

- 604-661-2800 (Lower Mainland)
- 1-800-663-3051 (elsewhere in B.C., Canada or U.S.)

Visit icbc.com or call 1-800-464-5050 for information on buying a used vehicle and to get a Vehicle Claims History Report.

Translation services available.

ICBC Prorate

ICBC's prorate office collects relevant taxes and licensing fees from B.C. carriers who require apportioned registration to operate their commercial vehicles interprovincially or into the U.S.

- Metro Vancouver: 604-443-4450
- Outside Vancouver: 1-800-665-4336

ICBC Tip Line

Call the Tip Line to report body shops using stolen parts or any fraudulent or exaggerated bodily injury or property damage claims.

All calls are confidential.

- Accessible 24 hours a day: 1-800-661-6844

Acts and regulations

National Safety Code

Pamphlets on the National Safety Code and Safety Code regulations are available at provincial weigh scales and at www.th.gov.bc.ca/cvse

Information is also available during regular business hours from the Provincial National Safety Code office in Victoria.

- Information: 250-952-0576

Other acts and regulations

Brochures providing information on the various provincial and federal acts and regulations that affect the commercial transport industry are available at all provincial weigh scales.

Acts and regulations may also be viewed on the Commercial Vehicle Safety and Enforcement website at www.th.gov.bc.ca/cvse

Travel information

Road reports (B.C.)

The Ministry of Transportation provides road reports. Call DriveBC to check road conditions for B.C. while in B.C. or anywhere in North America.

- DriveBC: 1-800-550-4997 (free)
- Website: drivebc.ca

Weather

Environment Canada provides weather information by phone and on online. For information on weather in Vancouver, Howe Sound, Whistler and Lower Fraser Valley:

- From Greater Vancouver: 604-664-9010
- For more information, talk directly to a forecaster: 1-900-565-5555 (charges apply)

For local, national and international weather information:

- Website: weather.gc.ca

Travelling into the U.S.

Get information on medical standards for driving commercial vehicles into the U.S. by contacting:

- Federal Motor Carrier Safety Administration: 360-753-9875
Suite 502 Evergreen Plaza Building
711 South Capitol Way
Olympia, Washington
U.S.A., 98501
- Website: fmcsa.dot.gov

Canada Customs

Provides detailed information on importation, restricted goods, tariffs, etc. Recorded information is available 24 hours a day. Customs officers are available during regular business hours.

- Vancouver area: 604-666-0545
- Toll-free outside the Vancouver area: 1-800-461-9999

B.C. Ferries

This number provides recorded schedule information and reservation bookings 24 hours a day. To make a reservation you must have a Visa, MasterCard or American Express.

- For information and bookings: 888-BCFERRY (223-3779)
- Website: bcferries.com

Tourism B.C.

Super Natural British Columbia provides travel information and reservation services for people travelling throughout B.C.

- For information and bookings: 1-800-HELLOBC (435-5622)
- Website: hellobc.com

Reporting forest fires

- Within B.C., report forest fire sightings to: 1-800-663-5555
- Cell: *5555

TaxiHost

This program is designed to help create a consistently high standard of taxicab service. Taxi drivers who want to work in Vancouver, Surrey, New Westminister or at the Vancouver International Airport must complete the TaxiHost program. For information, contact:

- Justice Institute of British Columbia: 604-528-5808
715 McBride Boulevard
New Westminister, B.C. V3L 5T4
- Website: jibc.ca

Metric conversion table

p.s.i. to kPa	
p.s.i.	kPa
1	6.89
2	13.78
3	20.68
4	27.57
5	34.47
6	41.36
7	48.26
8	55.15
9	62.05
10	68.94
15	103.42
20	137.89
25	172.36
30	206.84
35	241.31
40	275.78
45	310.26
50	344.73
55	379.20
60	413.68
65	448.15
70	482.62
75	517.10
80	551.57
85	586.04
90	620.52
95	654.99
100	689.47
105	723.94
110	758.41
115	792.89
120	827.36
125	861.83
130	896.31
135	930.78
140	965.25
145	999.73
150	1034.20

kPa to p.s.i.	
kPa	p.s.i.
5	0.72
10	1.45
15	2.17
20	2.90
25	3.62
30	4.35
35	5.07
40	5.80
45	6.52
50	7.25
60	8.70
70	10.15
80	11.60
90	13.05
100	14.50
150	21.75
200	29.00
250	36.29
300	43.51
310	44.96
350	50.76
400	58.01
415	60.19
450	65.26
500	72.51
550	79.77
585	84.84
600	87.02
650	94.27
700	101.52
725	105.15
750	108.77
800	116.03
850	123.28
900	130.53
950	137.78
1000	145.03
1050	152.29

Index

A

ABS..... See anti-lock braking system
ABS airbrake system 180-182
acts and regulations 256
 See also Motor Vehicle Act; National Safety Code; Passenger Transportation Act; Dangerous Goods Act; Commercial Transport Safety Act; Criminal Code of Canada; Motor Vehicle Safety Act (Canada)
acts of nature..... 53-54
aggregate loads..... 99-100
airbags..... See safety equipment
airbags and head restraints..... 60
air brake adjustment 185-194
 methods..... 188-189
 myths..... 193-194
air brake chamber 143-145
air brake courses 13
air brake endorsement..... 5-6
air brake operation..... 150-151
air brake pedal See foot valve treadle
air brake pre-trip inspection..... See pre-trip inspection
 tractor trailers 200-209
air brakes
 introduction..... 15-16
 operation..... 141-183
air disc brakes 174-175
air dryers..... 176-177
air lines 142
air-over-hydraulic brakes 175-176
alcohol evaporators 177-178
alcohol injectors 177-178
alleys, lanes and side roads 50
all-terrain cycles..... 4
all-terrain vehicles 4
ambulances 4, 127-128
anti-lock braking system 23-24
application pressure gauge 180
applied stroke method See brake adjustment
ATC.....
 See automatic traction control
ATVs See all-terrain vehicles
automatic drain valves 178
automatic front wheel limiting systems 178

automatic slack adjusters..... 191-193
automatic traction control..... 25
auxiliary transmissions..... 47

B

backing up 75-76
baggage..... 124
bagged products 99
blended air..... 162
blind spot 42-43
bobtail proportioning system 170
bobtailing..... 170
brake adjustment See air brake adjustment
brake fade 19
brake failure..... 57
brake inspection — industrial roads 249
brake lag time 17
brake response, tug and steering wheel slack test
 passenger vehicles 228
 single unit truck..... 217
 tractor trailers 209
 buses 224
brake signs 22
brake test
 industrial roads..... 249
 school buses 125
brakes
 See foot brake; spring brake; ratchet-and-pawl brake; air brakes; foundation brakes; safety actuator parking brakes; see also in-service brake checks
brakes — fire danger 64
braking
 basic principles 15-16
 hazards 21-25
braking time 17-19
bridges 35
bulkheads..... See front end structures
bus yield signs..... 120
buses
 licence requirements..... 3, 4
 following distance 28
 definition 117
 pre-trip inspection..... 218-224

- right-of-way 120
See also vehicle operation
- C**
- cab check See pre-trip inspection
- caging — spring parking brakes 160-161
- California spring brake parking systems
See spring parking brake emergency release system
- Canada Customs 257
- Canadian Transport Emergency Centre (CANUTEC) 253
- CANUTEC
See Canadian Transport Emergency Centre
- carbon monoxide poisoning 59
- cast spoke wheel problems 57
- cellphones 60-61
- central weight distribution point 90-92
- chains
ice 21
tiedown 93-95
- chauffeur See permits
- circle check See pre-trip inspections
- claims See ICBC
- Class 1 Licence 3
- Class 2 Licence 3
See also buses — pre-trip inspection
- Class 3 Licence 3
See also single-unit truck pre-trip inspection
- Class 4 Licence — restricted 4
- Class 4 Licence — code 20 — heavy trailer
endorsement 4
- Class 4 Licence — code 51 — house trailer
endorsement 4
- Class 4 Licence — unrestricted 4
See also buses — pre-trip inspection
- Class 5 Licence — code 20 — heavy trailer
endorsement 4
- Class 5 Licence — code 51 — house trailer
endorsement 4
- Class 6 Licence 4
- Class 7 Licence — GLP 4
- Class 8 Licence — GLP 4
- Code 18 — Industrial Air Brake Endorsement 248
- Code 19 — Industrial Air Brake Endorsement 248
- combination unit braking 23
- commercial driver training 12
- commercial passenger vehicle
definition 117
Commercial Transport Regulations 111-113
- commercial vehicle allowed signs 109-110
- commercial vehicle inspection
See decal, weigh scales, inspectors
- Commercial Vehicle Permit Line 254
- compensation 117
- compounding of brakes 160
- compressed air 141-142
- compressor 142-148
- construction See signs
- construction vehicles 4
- control line 164
- converter dolly 85
- coupling and uncoupling 78-84
- Criminal Code of Canada 62-63
- crossings 49-52
- curves and turns 34-38
- cycles See daily hours
- D**
- daily hours 133-134
- danger zones 30-31
- dangerous goods 108-109
- dangerous goods See transportation
emergency procedures 253
- dangerous goods inspectors 255
- dangerous goods signs 108-109
- decal — commercial vehicle inspection 123
- Dial-a-Claim See ICBC
- diesel fuel toxicity 63
- disabled passengers See passengers
- disabled vehicles 58
- disk wheel problems 57
- double clevis link 95
- double clutching 45
- double trailers 209
- downgrades 21-23
- drawbar 85
- driver licences, types of See licence classes
- driver medical examination form 5

- Driver's Medical Examination Report..... 14
- driver training schools
See commercial driver training
- Driver's Perception Time 17
- drugs 63
- drum brakes 16
- dual air brake system 151-156
- dual air tractor trailer system 171-173
- dual foot valve..... 152
- dynamiting trailer brakes 166, 168
- E**
- ECU See electronic control unit
- electronic control unit 181
- emergency equipment..... 123, 126
- emergency line..... See supply line
- emergency vehicles 44
- en route inspections..... 229
- endorsement code 15..... 5
See airbrake endorsement
- endorsements 5-6
- Environment Canada 254
- examinations
See medical fitness, vision screening, knowledge tests,
road tests, re-examination
- F**
- fatigue 63
- fifth wheel..... 78-89
- fire extinguishers 64-65
- fire prevention 63-64
- fire prevention See also brakes
- flashing lights 58
- following distance 27-28
- foot brake..... 57, 171
- foot valve treadle 150
- force multipliers..... 143
- forest fires..... 258
- foundation brakes 142
See also wedge brakes; air disc brakes; air-over
hydraulic brakes
- foundation brakes — s-cam type..... 145-146
- four-way flashers See signs
- front end structures..... 100-101
- front loads See TAC requirements
- front wheel limiting systems
automatic 178-179
manual..... 179
- fuel-efficient driving 67-74
smart-driving techniques 69-70
- fueling
passenger vehicle 124
school bus 126
- G**
- gasoline engines 46
- gauges
See reservoir pressure; application pressure
- gears..... See shifting gears
- glad hands..... 164
- governor
engine 46-47
compressor 146-147
- Gross Vehicle Weight..... 111
- Gross Vehicle Weight Rating 111, 131
- GVW..... See Gross Vehicle Weight
- GVWR..... See Gross Vehicle Weight Rating
- H**
- hanging meat..... See specific cargo types
- hay..... 101, 110
- head restraints..... See safety equipment
- heavy trailer..... 4
- heavy trailer endorsement..... 2-3
- height See vehicle dimension
- highway crossing permit..... 250
- hours of service 131-140
- house trailer 4
- humpback crossing 52
- I**
- ICBC 256
- icy roads 21
- impaired driving..... 61-63
- industrial air brake endorsement..... 248
- industrial roads..... 247
- information and destination signs See signs
- Inspections

See pre-hill; en route; post-trip; pre-trip; industrial roads inspector 113-114
intermodal containers See specific cargo types
intersections 49-50

J

jackknife 24
jump seats 122

K

Kilopascals (kPa) 145
 See also pounds per square inch
knowledge tests 8

L

lane control signals 240
lane use 43
language requirements 7
leverage 144
licence classes 3-4
licence downgrade 14
license upgrade 14
Licensed Gross Vehicle Weight 111
limiting systems
 See automatic front wheel; manual front wheel
limousines
 licensing 4
 following distance 27-28
 definition 117
 livestock See specific cargo types
load-encircling binders 96-99
loading 89-107
loads — inspection for wear 93
loads, types of See aggregate loads
 See also specific cargo types, dangerous goods, overload or oversize
logbooks 136-137
long load signs 113
low-air warning device 153-154
lugging 45

M

manoeuvring
 trucks 31-42

buses, limousines and taxis 119-120
manual front wheel limiting system 179
manual slack adjuster 189-191
mechanical circle check See pre-trip inspection
medical examination processing fee 14
medical fitness 5
 examinations 14
 qualifications 255-256
mirrors
 school buses 126
 side 110
 using 43
modulator 181
Motor Carrier Branch
 See Passenger Transportation Branch
motorcycles 4
motorcycles — limited-speed 4
motorhomes 4
Motor Vehicle Act
 hours of service 131
 tire tread depth 56
 securing cargo 92
 See also impaired driving; buses — right of way; baggage; taxis — signs
Motor Vehicle Safety Act (Canada) 117
multi-speed rear axles 47

N

narrow road signs 109, 237
National Safety Code 131, 195, 257
night driving 54
Northwest Territories See other jurisdictions
Nunavut See other jurisdictions

O

object markers See signs
off-duty time 132
RoadSafetyBC 7, 8
off-tracking 32-33
on-duty time 132
one-way check valve 152
other jurisdictions — hours of service 138-139
out-of-province licence 6, 14
overload and oversize load 111-112

P

p.s.i. See pounds per square inch

pallets 99

parking 48-49

 industrial roads 249-250

 trailers 76

 See also signs

parking brake control valve 159

parking brakes 156

Passenger Transportation Act

 See jump seats; emergency equipment

Passenger Transportation Branch 255

passenger vehicles 4

passengers

 refusal to transport 122

 disabled 122-123

 school buses 126

passing 47-48, 120

peace officer See inspector

PEP See Provincial Emergency Program

permits

 amber flashing light 58

 oversize and overload 112

 chauffeur 123

 See also highway crossing; Commercial Vehicle Permit Line

personal safety 59-65

pilot car 112

pintle hitch 85-89

pole trailer 85

pop-off valve See safety valve

post-trip inspections 231

pre-hill inspections 228

pressure protection valves 180

pre-trip inspection

 passenger vehicle 225-228

 tractor trailer Class 1 Licence 200-209

 buses — Class 2 or Class 4 unrestricted 218-224

 single unit truck — Class 3 210-217

 See also mechanical circle check

pre-trip inspection report — road test 197-198

primary air system — failure 172

primary brake See foot brake

primary reservoir

 dual air brake system 151-152

Prorate See ICBC

Provincial Commercial Vehicle Safety and Enforcement 254

Provincial Emergency Program

 dangerous goods 253

pry method of free stroke measurement

 See air brake adjustment

public transportation — definition 117

Q

quick release valve 154-155

R

r.p.m. — definition 21

railway crossings 51-52

railway signs 240

ratchet-and-pawl brake 57

rear loads 102

recreational trailer

 licence requirements 4

re-examination — driver licence 13

refueling See fueling

regulatory signs See signs

relay emergency valve 165

relay valve 155-156

reports

 defects or deficiency 125

 pre-trip 197-198

reserved lane See signs

reservoir pressure gauge 153

reservoirs 141-183

retarders 20

revolutions per minute (r.p.m.)

 definition 21

ride-hail vehicles 117

right-of way

 industrial roads 249-250

 rules 49

 See also buses

road markings 242-244

 See also yellow lines; white lines; reserved lane

road rage 63

road reports..... 257
 RoadSafetyBC 7, 8
 road test vehicles 10-12
 road tests..... 10
 rollers..... 99
 rollovers..... 76
 roundabouts..... 38-39
 runaway lane 23

S

safety See personal safety
 safety actuator parking brakes..... 163-164
 safety equipment 59-60
 See also emergency equipment
 safety valve..... 149
 s-cam drum brake 145-146
 adjustment 185-187
 school bus
 licence requirements..... 4
 operating..... 125-127
 See also signs
 school, playground and crosswalk signs..... See signs
 seatbelts..... See safety equipment
 secondary reservoir
 dual air brake system 151-152
 semi-trailers
 licence requirements..... 3
 service line..... See control line
 shifting gears..... 44-47
 side loads 101
 signals..... 240-241
 signs
 turn control..... 236
 parking 236
 reserved lane..... 236
 object markers 238
 construction 239
 lane use 235
 school buses 126
 railway 240
 school, playground and crosswalk signs 235
 information and destination 239

regulatory 234
 warning 237-238
 See also dangerous goods; long load; pilot car; narrow road; oversize load; railway crossing; runaway; slow moving vehicle; weigh scale; wide load
 single unit truck..... See pre-trip inspection — Class 3
 slack adjuster..... 187-194
 slippery road valve 178-179
 slow moving vehicle warning sign 29
 smoking and alcohol..... 121, 124
 snow tires 21
 special activity bus – definition 4, 117
 special vehicle 4, 117
 specific cargo types 102-107
 speed and weight 18
 spills — dangerous goods 253
 spring parking brake 157-163
 trailer 164-168
 emergency release..... 179
 starting and stopping..... 16-19
 steering methods..... 37
 stopping 16-19
 stopping power..... 18-19
 supply line 164
 supply reservoir
 dual air brake system 152-153

T

T.A.C. vehicle
 See Transportation Association of Canada
 tank loads..... See specific cargo types
 tarps 99
 TaxiHost program..... 258
 taxis
 licence requirements..... 4
 following distance 28
 definition 117
 signs 121
 See also pre-trip-inspection — passenger vehicle
 tiedown 93-99
 Tip Line..... See ICBC
 tires and wheels 55-57
 total stopping distance 17

- tow car 4
- towed vehicles See trailers
- towing 76-89
- traction 34
- tractor-trailer air brake systems 164-176
- traffic circles 38-39
- traffic flow
- definition 28-29
- traffic lights 241
- trailers
- licence requirements 3-4
- Transportation Association of Canada
- vehicle requirements 101
- trip inspection See pre-trip inspection; reports
- truck crane — mobile 4
- turning radius 31-33
- turns 34-38
- two-axle vehicles
- licence requirements 4
- two-second rule 17, 28
- two-way check valve 162
- U**
- under hood check See pre-trip inspection
- United States See other jurisdictions
- United States
- travel information 257
- used vehicles See ICBC
- V**
- vacuum brakes 57
- valves
- See relay valve; quick release valve; foot treadle valve; one-way check valve; parking brake control valve; two-way check valve; relay emergency valve; bobtail proportioning system; slippery road valve
- van
- following distance 28
- vehicle dimensions 110-111
- vehicle insurance 9
- vehicle operation
- bus, taxi or limousine 121-125
 - emergency vehicles 127-128
 - school buses 125-127
- visibility 42-44
- vision screening 5
- W**
- warning devices
- low air 153-154
 - disabled vehicles 58
- warning signals
- industrial roads 249-250
- warning signs See signs
- warning systems
- brake failure 57
- water cooled brakes 249
- weather conditions 53-54
- weather reports 257
- webbing 97
- wedge brakes 174
- weigh scales 113-114
- wet tank See supply reservoir
- wheel position 31
- wheelbase
- definition 32
- whipping 77
- white lines 243
- wide load 113
- width See vehicle dimension
- wig-wag See warning device — low air
- Y**
- yellow lines 242
- Yukon See other jurisdictions

Examiners' tips for passing the Class 1, 2, 3 and 4 road tests

You'll do best on the pre-trip inspection test and road test if you practise these requirements:

- Make sure that the vehicle you're using can pass a safety inspection. Check that all the lights work (particularly trailer brake lights and turn signals), and that the air brake system is in good condition. Bring appropriate tools.
- Know your vehicle:
 - Practise the pre-trip inspection. Make sure that you can find all the items you'll be inspecting as part of the pre-trip. Have someone watch you conduct the pre-trip inspection and have them tick off the items you're checking to make sure you complete everything and can explain what you're doing.
 - Make sure you're familiar with driving the vehicle you are using for your road test, particularly its handling and turning characteristics and gearshift operation. As part of the road test, you'll be assessed on your ability to shift gears smoothly.
- Drive posted speed limits. Don't keep up to speeding traffic. Watch for school zones and playgrounds.
- Make full stops for stop signs, and stop in the correct position. When it's safe to move out, pull out slowly, scanning the intersection.
- Use the correct traffic lane. Make proper turns as described in this guide.
- Mirror check and, if possible, shoulder check whenever you change lanes or direction.
- Keep a safe distance from other vehicles.
- Scan intersections before driving through, even if the light is green when you approach.
- Observe when backing up.
- Be familiar with commercial vehicle procedures for crossing railway tracks.

Identification (ID)

Every time you go to a driver licensing office, you'll need to take one piece of primary ID and one piece of secondary ID. Identification requirements are subject to change. Please see icbc.com/acceptedID for a current list of accepted ID.

Prepare for your tests!

If you do not qualify on the knowledge test you will need to wait seven days before another attempt can be made. For road tests, the re-test waiting period is 14 days after a first attempt, 30 days after a second attempt, and 60 days for any subsequent attempts.

New to B.C.?

Ensure you provide one primary and one secondary piece of ID and remember to bring your non-B.C. licence.

Has your name changed since birth?

Driver licences and B.C. Identification cards are issued in **legal name only**. If your name differs from that shown on your primary identification, you will also need to provide ALL name change documents to link back to your primary ID.

Photocopies are not accepted. The only exception is a photocopy that is certified as a true copy by the government agency that issued it.

One piece primary ID	
BC Driver's Licence (BCDL) (Must not be expired more than 3 years)	Canadian Passport (Must be valid and in exactly the same name as your Canadian Birth Certificate or Canadian Citizenship Certificate. If not, additional name linking document(s) will be required.)
BC Identification Card (BCID) (Must not be expired more than 3 years)	Canadian Record of Landing (Some exceptions apply)
BC Services Card with photo (Standalone or Combo) (Must not be expired more than 3 years)	Permanent Resident Card (Must not be expired)
Canadian Birth Certificate (Baptismal and Live Birth Certificates are not acceptable)	Student, Work, Visitor or Temporary-resident Permit (Form number is IMM1442) (Must not be expired)
Canadian Citizenship Card/Certificate (Commemorative certificates are not accepted)	
Indigenous Primary ID	
Certificate of Indian Status (Laser engraved photo cards with security features, issued by the Government of Canada) (White Card)	

One piece secondary ID	
Bank Card (Both your imprinted name and signature must appear on the card)	Health Card issued by other Canadian Province or Territory (Health Care Cards issued by AB not accepted as secondary)
BC Services Card Non Photo	Legal Name Change Certificate (Issued by Canadian Court or Canadian Provincial Vital Statistics Agency)
Birth Certificate from foreign country	Marriage Certificate (Issued by a vital statistic agency, religious organization or marriage commissioner)
Canadian Forces Identification	Nexus Card
Credit Card (Both your imprinted name and signature must appear on the card)	Passport (Foreign) (Must be valid and in exactly the same name as your Birth Certificate, Citizenship Cert., PRC or IMM. If not additional name linking document(s) will be required)
Department of National Defence 404 Licence	Canadian Passport (Must be valid and in exactly the same name as your Canadian Birth Certificate or Canadian Citizenship Certificate. If not, additional name linking document(s) will be required.)
Driver's Licence (Canadian or U.S.)	Police Identification Card
Employee ID Card (Must have name and photo)	Student Card or ID (Current year, name and photo must be imprinted)
Indigenous Secondary ID	
Certificate of Indian Status (Orange Laminated cards)	Métis Nation BC Citizenship and ID Card
Tla'amin Nation Citizenship Card	

A Combination BCDL/BCSC can only be used as one piece of ID.

If you were born outside Canada and do not have any of the required primary identification documents, please contact Citizenship and Immigration Canada at 1-888-242-2100.

Visit [icbc.com](https://www.icbc.com) to:

- view and download this and other driver licensing guides and manuals
- view ICBC driving tips
- learn more about driver and vehicle licensing in B.C.
- get information on our products, services and news.